

MODEL 203

Illustrated on model 203.0

- 1 Door handle
- 2 Screws
- 3 Lock trim surround
- 4 Door liner
- E17/3 Left front door entrance and exit lamp
- E17/4 Right front door entrance and exit lamp
- H4/23 Left front door mirror triangle speaker
- H4/24 Right front door mirror triangle speaker

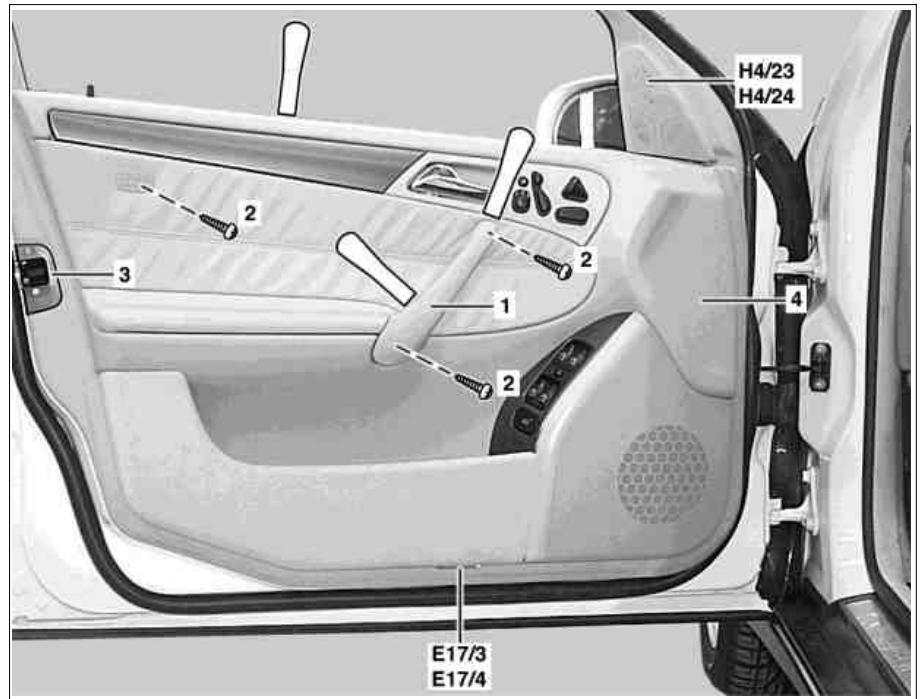

P72.10-2177-06

Illustrated on model 203.7

- 2 Screws
- 3 Lock trim surround
- 4 Door liner
- H4/23 Left front door mirror triangle speaker
- H4/24 Right front door mirror triangle speaker

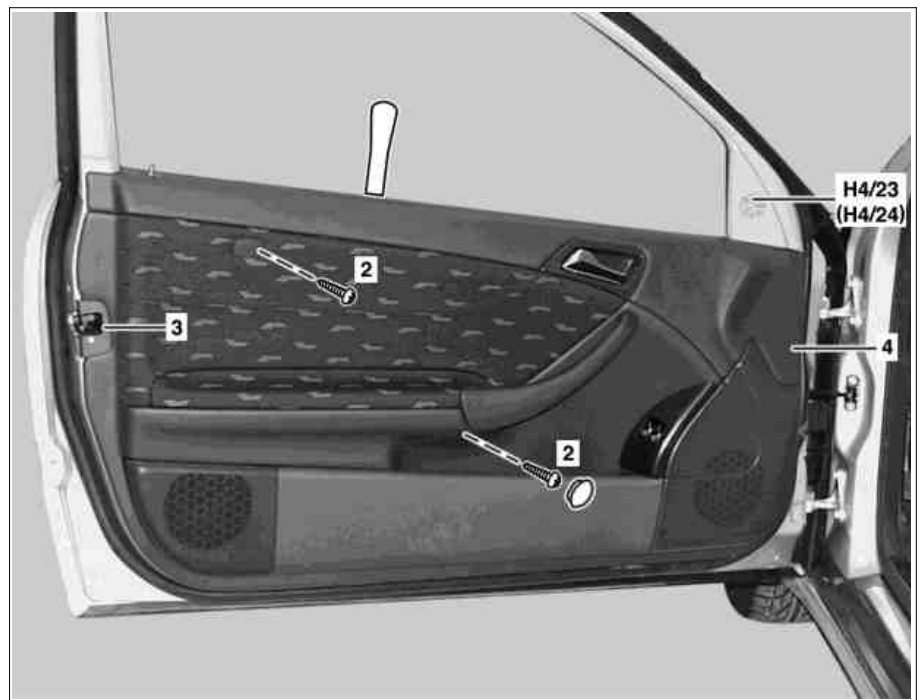

P72.10-2277-06

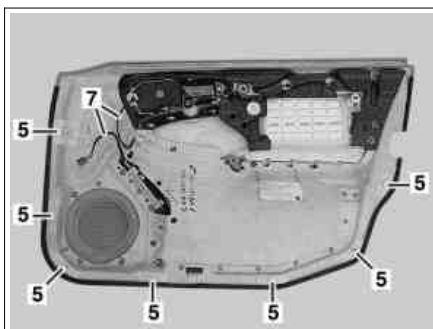

P72.10-2178-01

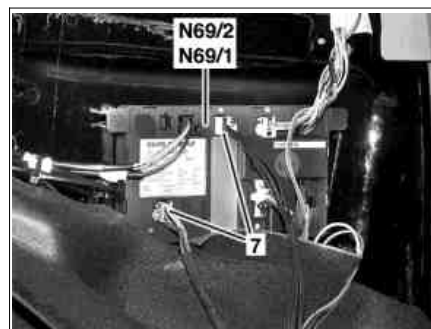

P54.21-2070-01

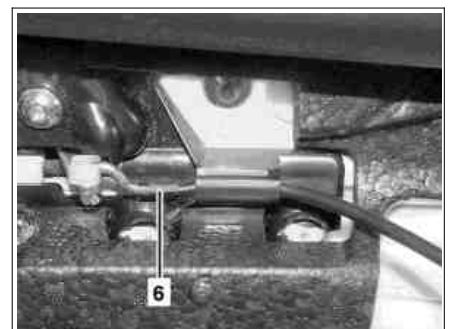











P72.10-2179-01

Illustrated on model 203.0

- 5 Clips

- 6 Control cable
- 7 Connectors

- N69/1 Right front door control module
- N69/2 Left front door control module

	Removing, installing		
1	Position assembly wedge at top of door handle (1) and press off	Model 203.0 / 203.2  Press not more than 10 mm out of the catch.  Assembly wedge	*110589035900
2	Position assembly wedge at bottom of door handle (1) and press off	Model 203.0 / 203.2  Assembly wedge	*110589035900
3	Take out door handle (1)	Model 203.0 / 203.2	
4	Unclip SRS cover		
5	Unscrew screws (2)		
6	Unhook front entrance and exit lamp and disconnect connector	With code (611) 2 exit lamps in front doors  Left front door entrance and exit lamp (E17/3), right front door entrance and exit lamp (E17/4).	
7	Remove door mirror triangle speaker	With code (810) sound system  Left front door mirror triangle speaker (H4/23), right front door mirror triangle speaker (H4/24).	AR82.62-P-7850P
8	Remove lock trim surround (3)	 Torx bit set	*000589011000
9	Press door liner (4) off of inner door panel at bottom, front and rear in area of clips (5) with assembly wedge	 Inspect clips for damage.  Assembly wedge	*110589035900
10	Use assembly wedge to lift top of door liner (4) out of inner sealing rail	 Assembly wedge	*110589035900
11	Unhook control cable (6) from inner door actuation		
12	Detach connectors (7)	 On left front door control module (N69/1), right front door control module (N69/2).	
13	Lay door liner (4) down		
14	Install in the reverse order		

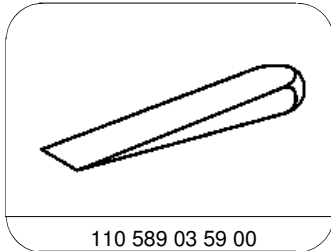

Assembly wedge

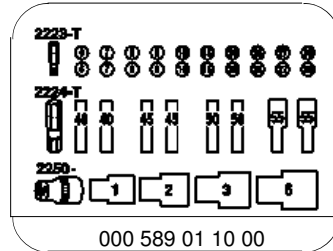

Torx bit set