

CLK 320

CLK 500

CLK 55 AMG

Our company and staff congratulate you on the purchase of your new Mercedes-Benz.

Your selection of our product is a demonstration of your trust in our company name. Further, it exemplifies your desire to own an automobile that will be as easy as possible to operate and provide years of service.

Your Mercedes-Benz represents the efforts of many skilled engineers and craftsmen. To help assure your driving pleasure, and also the safety of you and your passengers, we ask you to make a small investment of time:

- Please read this manual carefully before putting it aside. Then return it to your vehicle where it will be handy for your reference.
- Please follow the recommendations contained in this manual. They are designed to acquaint you with the operation of your Mercedes-Benz.

- Please pay attention to the warnings and cautions contained in this manual. They are designed to help improve the safety of the vehicle operator and occupants.

We extend our best wishes for many miles of safe, pleasurable driving.

Mercedes-Benz USA, LLC
A DaimlerChrysler Company

Introduction	9
Product information	9
Operator's Manual	10
Service and warranty information ..	10
Important notice for California retail buyers and lessees of	
Mercedes-Benz automobiles	11
Maintenance	12
Roadside Assistance	12
Change of address or ownership....	12
Operating your vehicle outside the USA or Canada.....	13
Where to find it.....	14
Symbols.....	15
Operating safety	16
Proper use of the vehicle	16
Problems with your vehicle.....	17
Reporting safety defects.....	18
Reporting safety defects	18

At a glance	19
Cockpit.....	20
Instrument cluster	22
Multifunction steering wheel	24
Center console	25
Upper part	25
Lower part	26
Overhead control panel	27
Door control panel.....	28

Getting started	29
Unlocking	30
Unlocking with the SmartKey	30
Unlocking with KEYLESS-GO*	32
Adjusting.....	34
Seats	34
Steering wheel.....	37
Mirrors.....	38
Driving.....	40
Fastening the seat belts	40
Starting the engine	43
Switching on headlamps.....	46
Turn signals and high beam	47
Windshield wipers.....	47
Problems while driving.....	49
Parking and locking.....	50
Parking brake	50
Switching off headlamps.....	51
Turning off engine	51

Safety and Security	55
Occupant safety	56
Airbags	57
Seat belts	62
Children in the vehicle	66
Blocking of rear side window operation	72
Panic alarm	73
Activating	73
Deactivating	73
Driving safety systems	74
ABS	74
BAS	76
ESP	76
Anti-theft systems	79
Immobilizer	79
Anti-theft alarm system	80
Tow-away alarm	81

Controls in detail	83
Locking and unlocking	84
Keys	84
SmartKey with KEYLESS-GO*	88
Opening the doors from the inside ..	92
Opening the trunk from the inside ..	92
Trunk lid emergency release	93
Closing the trunk lid	94
Separately locking the trunk	94
Separately unlocking the trunk	95
Automatic central locking	95
Locking and unlocking from the inside	95
Seats	97
Easy-entry/exit feature	97
Head restraints	97
Multicontour seat*	100
Heated seats*	101
Memory function	102
Storing positions into memory	103
Recalling positions from memory ..	103
Storing parking position	103

Lighting	105
Exterior lamp switch	105
Combination switch	107
Hazard warning flasher	108
Interior lighting	109
Door entry lamps	110
Instrument cluster	111
Instrument cluster illumination	111
Coolant temperature display	112
Trip odometer	112
Tachometer	113
Outside temperature indicator	113
Control system	114
Multifunction display	114
Multifunction steering wheel	115
Menus	117
Standard display menu	119
AUDIO menu	119
NAV menu	121
Distronic* menu	121
Malfunction memory menu	122
Settings menu	123
Trip computer menu	136
TEL menu*	138

Automatic transmission.....	141	Rear window defroster.....	162	PARKTRONIC system*	208
One-touch gearshifting.....	142	Air conditioning.....	163	Loading	212
Gear ranges	143	Residual heat and ventilation*	163	Roof rack	212
Gear selector lever position	144	Rear passenger compartment		Ski sack*	212
Program mode selector switch.....	145	adjustable air vents.....	164	Split rear bench seat	215
Accelerator position.....	146	Audio system.....	165	Loading instructions	217
Emergency operation		Audio and telephone, operation....	165	Cargo tie-down rings.....	218
(Limp Home Mode)	146	Operating safety	165	Useful features.....	219
Steering wheel gearshift control		Operating and display elements....	166	Interior storage spaces	219
(Speedshift) and manual		Button and soft key operation.....	168	Ashtrays.....	223
shift program CLK 55 AMG	146	Operation.....	168	Cigarette lighter.....	224
Good visibility	149	Radio mode.....	171	Floor mats*	225
Rear view mirror.....	149	Cassette mode.....	174	Telephone*	226
Parking position	150	CD changer* operating mode	178	Tele Aid.....	227
Windshield wipers	151	Telephone* operation	182	Garage door opener.....	235
Headlamp cleaning system*	151	Power windows	187		
Sun visors	152	Opening and closing the windows.	187		
Rear window sunshade*	153	Synchronizing power windows.....	189		
Automatic climate control	154	Sliding/pop-up roof*	190		
Setting the temperature.....	157	Opening and closing the			
Adjusting air distribution.....	158	sliding/pop-up roof.....	190		
Adjusting air volume	159	Synchronizing the			
Maximum cooling MAXCOOL	159	sliding / pop-up roof	192		
Defrosting	159	Driving systems	193		
Air recirculation mode.....	160	Cruise control	193		
Charcoal filter	161	Distronic*	196		

Contents

Operation	239	At the gas station	251	Maintenance.....	266
The first 1000 miles (1500 km)	240	Check regularly and		Clearing the service indicator	266
Driving instructions.....	241	before a long trip.....	252	Service term exceeded	266
Drive sensibly – save fuel	241	Engine compartment	253	Calling up the service indicator....	267
Drinking and driving	241	Hood	253	Resetting the service indicator	267
Pedals	241	Engine oil	254	Vehicle care.....	268
Power assistance	241	Transmission fluid level.....	256	Cleaning and care of vehicle	268
Brakes	242	Coolant	256		
Driving off.....	243	Battery	258		
Parking.....	243	Windshield washer system and			
Tires	244	headlamp cleaning system*	259		
Hydroplaning.....	245	Tires and wheels.....	260		
Tire traction.....	245	Important guidelines	261		
Tire speed rating	245	Life of tires.....	261		
Winter driving instructions	246	Direction of rotation.....	261		
Standing water	247	Checking tire inflation pressure ...	262		
Passenger compartment	247	Rotating wheels	263		
Driving abroad.....	247	Winter driving	264		
Control and operation of		Winter tires	264		
radio transmitters.....	248	Block heater*	265		
Catalytic converter.....	248	Snow chains.....	265		
Emission control.....	249				
Coolant temperature	250				

Practical hints	275	Replacing wiper blades.....	323	Technical data	339
What to do if ...?.....	276	Removing.....	323	Spare parts service	340
Lamps in instrument cluster	276	Installing.....	323	Warranty coverage	341
Lamp in center console.....	282	Flat tire.....	324	Loss of Service and Warranty	
Messages in the display.....	283	Preparing the vehicle	324	Information Booklet.....	341
Where will I find...?	305	Mounting the Minispare wheel.....	324	Identification labels	342
First aid kit.....	305	Battery.....	329	Layout of poly-V-belt drive.....	343
Vehicle tool kit.....	305	Disconnecting the battery.....	330	CLK 320 / CLK 500 /	
Minispare wheel.....	307	Removing the batteries.....	330	CLK 55 AMG	343
Unlocking/locking in an emergency..	310	Charging and		Engine	344
Unlocking the vehicle.....	310	reinstalling batteries	330	Rims and tires	345
Locking the vehicle	311	Reconnecting the batteries.....	331	Same size tires	345
Changing batteries.....	312	Jump starting.....	332	Mixed size tires.....	346
Fuel filler flap	313	Towing the vehicle	334	Minispare wheel.....	347
Manually unlocking the		Towing the vehicle	334	Electrical system	348
transmission selector lever	313	Installing towing eye bolt	336	Main dimensions	349
Opening/closing in an emergency.....	314	Fuses.....	337	Weights	350
Sliding/pop-up roof	314	Fuse box in			
Replacing bulbs	316	Fuse box in			
Bulbs.....	316	passenger compartment.....	337		
Replacing bulbs for front lamps ...	318	Fuse box in engine compartment..	337		
Side marker lamp bulb.....	321	Auxiliary fuse box in trunk.....	338		
Replacing bulbs for rear lamps.....	322				

Contents

Fuels, coolants, lubricants, etc.	351	
Capacities	351	Technical terms 361
Engine oils.....	353	
Engine oil additives	353	
Air conditioning refrigerant	353	Index 367
Brake fluid.....	353	
Premium unleaded gasoline	354	
Fuel requirements	354	
Gasoline additives	354	
Coolants.....	355	
Windshield and headlamp washer system.....	357	
Consumer information	358	
Uniform tire quality grading.....	358	

Product information

Please observe the following in your own best interest:

We recommend using Mercedes-Benz original parts as well as conversion parts and accessories explicitly approved by us for your vehicle model.

We have tested these parts to determine their reliability, safety and their special suitability for Mercedes-Benz vehicles.

We are unable to make an assessment for other products and therefore cannot be held responsible for them, even if in individual cases an official approval or authorization by governmental or other agencies should exist. Use of such parts and accessories could adversely affect the safety, performance or reliability of your vehicle. Please do not use them.

Mercedes-Benz original parts as well as conversion parts and accessories approved by us are available at your authorized Mercedes-Benz Center where you will receive comprehensive information, also on permissible technical modifications, and where proper installation will be performed.

Operator's Manual

Operator's Manual

This Operator's Manual contains a great deal of useful information. We urge you to read it carefully and familiarize yourself with the vehicle before driving.

For your own safety and longer service life of the vehicle, we urge you to follow the instructions and warnings contained in this manual. Ignoring them could result in damage to the vehicle or personal injury to you or others. Vehicle damage caused by failure to follow instructions is not covered by the Mercedes-Benz Limited Warranty.

Your vehicle may have some or all of the equipment described in this manual. Therefore, you may find explanations for optional equipment not installed in your vehicle. If you have any questions about the operation of any equipment, your authorized Mercedes-Benz Center will be glad to demonstrate the proper procedures.

We continuously strive to improve our product, and ask for your understanding that we reserve the right to make changes in design and equipment. Therefore, information, illustrations and descriptions in this Operator's Manual might differ from your vehicle.

Optional equipment is also described in this manual, including operating instructions wherever necessary. Since they are special-order items, the descriptions and illustrations herein may vary slightly from the actual equipment of your vehicle.

If there are any equipment details that are not shown or described in this Operator's Manual, your authorized Mercedes-Benz Center will be glad to inform you of correct care and operating procedures.

The Operator's Manual and Service Booklet are important documents and should be kept with the vehicle.

Service and warranty information

The Service and Warranty Information Booklet contains detailed information about the warranties covering your Mercedes-Benz, including:

- New Car Limited Warranty,
- Emission System Warranty,
- Emission Performance Warranty,
- California, Maine, Massachusetts, and Vermont Emission Control System Warranty (California, Maine, Massachusetts, and Vermont only),
- State Warranty Enforcement Laws (Lemon Laws).

Important notice for California retail buyers and lessees of Mercedes-Benz automobiles

Under California law you may be entitled to a replacement of your vehicle or a refund of the purchase price or lease price, if Mercedes-Benz USA, LLC and / or its authorized repair or service facilities fail to fix one or more substantial defects or malfunctions in the vehicle that are covered by its express warranty after a reasonable number of repair attempts. During the period of 18 months from original delivery of the vehicle or the accumulation of 18 000 miles (approx. 29 000 km) on the odometer of the vehicle, whichever occurs first, a reasonable number of repair attempts is presumed for a retail buyer or lessee if one or more of the following occurs:

- (1) the same substantial defect or malfunction results in a condition that is likely to cause death or serious bodily injury if the vehicle is driven, that defect or malfunction has been subject to repair two or more times, and you have directly notified Mercedes-Benz USA, LLC in writing of the need for its repair,
- (2) the same substantial defect or malfunction of a less serious nature than category (1) has been subject to repair four or more times and you have directly notified us in writing of the need for its repair, or
- (3) the vehicle is out of service by reason of repair of the same or different substantial defects or malfunctions for a cumulative total of more than 30 calendar days. Written notification should be sent to us, not a dealer, at Mercedes-Benz USA, LLC, Customer Assistance Center, One Mercedes Drive, Montvale, NJ 07645-0350.

Maintenance

The Service Booklet describes all the necessary maintenance work which should be performed at regular intervals.

Always have the Service Booklet with you when you take the vehicle to your authorized Mercedes-Benz Center for service. The service advisor will record each service in the booklet for you.

Roadside Assistance

The Mercedes-Benz Roadside Assistance Program provides factory trained technical help in the event of a breakdown. Calls to the toll-free Roadside Assistance number

1-800-FOR-MERCEdes (in the USA)
1-800-387-0100 (in Canada)

will be answered by Mercedes-Benz Customer Assistance Representatives 24 hours a day, 365 days a year.

For additional information refer to the Mercedes-Benz Roadside Assistance Program brochure in your glove box.

Change of address or ownership

If you change your address, be sure to send in the "Change of Address Notice" found in the Service and Warranty Information Booklet, or simply call the Mercedes-Benz Customer Assistance Center (in the USA) at 1-800-FOR-MERCEdes, or Customer Service (in Canada) at 1-800-387-0100. It is in your own interest that we can contact you should the need arise.

If you sell your Mercedes, please leave all literature with the vehicle to make it available to the next operator.

If you bought this vehicle used, be sure to send in the "Notice of Purchase of Used Car" found in the Service and Warranty Information Booklet, or call the Mercedes-Benz Customer Assistance Center (in the USA) at 1-800-FOR-MERCEdes, or Customer Service (in Canada) at 1-800-387-0100.

Operating your vehicle outside the USA or Canada

If you plan to operate your vehicle in foreign countries, please be aware that:

- Service facilities or replacement parts may not be readily available,
- unleaded gasoline for vehicles with catalytic converters may not be available; the use of leaded fuels will damage the catalyts,
- gasoline may have a considerably lower octane rating, and improper fuel can cause engine damage.

Certain Mercedes-Benz models are available for delivery in Europe under our European Delivery Program. For details, consult your authorized Mercedes-Benz Center or write to:

In the USA:

Mercedes-Benz USA, LLC
European Delivery Department
One Mercedes Drive
Montvale, NJ 07645-0350

In Canada:

Mercedes-Benz Canada, Inc.
European Delivery Department
849 Eglinton Avenue East
Toronto, Ontario M4G 2L5

Where to find it

Where to find it

This Operator's Manual is designed to provide comprehensive support information for you, the vehicle operator. For you to find information quickly each section has its own reference color:

At a glance

Here you will find an overview of all the controls that can be operated from the driver's seat.

Getting started

Here you will find all the information you need for your first drive. You should read this section first if this is your first Mercedes-Benz vehicle or if you are renting or borrowing this vehicle.

Safety and Security

Here you will find descriptions of the safety features in your vehicle.

Controls in detail

Here you will find detailed information about the equipment installed in your vehicle. This section expands on the "Getting started" section and also describes technical innovations. If you are already familiar with the basic functions of your vehicle, this section will be of particular interest to you.

Operation

Here you will find all the information you need for the proper operation of your vehicle.

Practical hints

This section provides fast assistance for dealing with problems you may encounter.

Technical data

All important technical data for your vehicle can be found in this section.

Indexes

The glossary provides explanations of the most important technical terms.

The table of contents and the index are designed to help you find information quickly and easily.

The following publications are part of your vehicle documentation:

- this Operator's Manual
- the Service Booklet

Separate operating instructions will be provided as required depending on the equipment options installed in your vehicle.

Symbols

The following symbols are found in this Operator's Manual:

- * Optional equipment is identified with an asterisk. Since standard equipment varies between models, the descriptions and illustrations in this manual may differ slightly from the actual equipment of your vehicle.

Warning!



Warning notices draw your attention to hazards that may endanger your health or life, or the health or life of others.



Highlights hazards that may result in damage to your vehicle.



Helpful hints or further information you may find useful.

- ▶ This symbol points to instructions for you to follow.
- ▶ A number of these symbols appearing in succession indicates a multiple-step procedure.
- ▷ Page This symbol tells you where to look for further information on a topic.
- ▷▷ This continuation symbol marks an interrupted procedure which will be continued on the next page.
- > In the glossary of technical terms, this symbol is used to cross-reference term definitions.
- Display Words appearing in the multi-function display are printed in the type shown here.

Operating safety

Operating safety

Warning!



Work improperly carried out on electronic components and associated software could cause them to cease functioning. Because the vehicle's electronic components are interconnected, any modification made may produce an undesired effect on other systems.

Electronic system malfunctions could seriously impair the operating safety of your vehicle.

Ensure that any repairs or modifications to electronic components are carried out by an authorized Mercedes-Benz Center.

Other improper work or modifications on the vehicle could also have a negative impact on the operating safety of the vehicle.

Some safety systems only function while the engine is running. You should therefore never turn off the engine while driving.

Proper use of the vehicle

Proper use of the vehicle requires that you are familiar with the following information and rules:

- the safety precautions in this manual
- the “Technical data” section in this manual
- traffic rules and regulations
- motor vehicle laws and safety standards

Problems with your vehicle

If you should experience a problem with your vehicle, particularly one that you believe may affect its safe operation, we urge you to immediately contact your authorized Mercedes-Benz Center to have the problem diagnosed and corrected if required. If the matter is not handled to your satisfaction, please discuss the problem with the Mercedes-Benz Center management, or if necessary contact us at one of the following addresses:

In the USA:

Customer Assistance Center
Mercedes-Benz USA, LLC
One Mercedes Drive
Montvale, NJ 07645-0350

In Canada:

Customer Relations Department
Mercedes-Benz Canada, Inc.
849 Eglinton Avenue East
Toronto, Ontario, M4G 2L5

Reporting safety defects

Reporting safety defects

For the USA only:

The following text is published as required of manufacturers under Title 49, Code of U.S. Federal Regulations, Part 575 pursuant to the “National Traffic and Motor Vehicle Safety Act of 1966”.

Reporting safety defects

If you believe that your vehicle has a defect which could cause a crash or could cause injury or death, you should immediately inform the National Highway Traffic Safety Administration (NHTSA) in addition to notifying Mercedes-Benz USA, LLC.

If NHTSA receives similar complaints, it may open an investigation, and if it finds that a safety defect exists in a group of vehicles, it may order a recall and remedy campaign. However, NHTSA cannot become involved in individual problems between you, your dealer, or Mercedes-Benz USA, LLC.

To contact NHTSA, you may either call the Auto Safety Hotline toll-free at 1-888-327-4236 (or 366-0123 in Washington, D.C. area) or write to: NHTSA, U.S. Department of Transportation, Washington, D.C. 20590. You can also obtain other information about motor vehicle safety from the Hotline.

At a glance

Cockpit

Instrument cluster

Multifunction steering wheel

Center console

Overhead control panel

Door control panel



At a glance

Cockpit

Cockpit

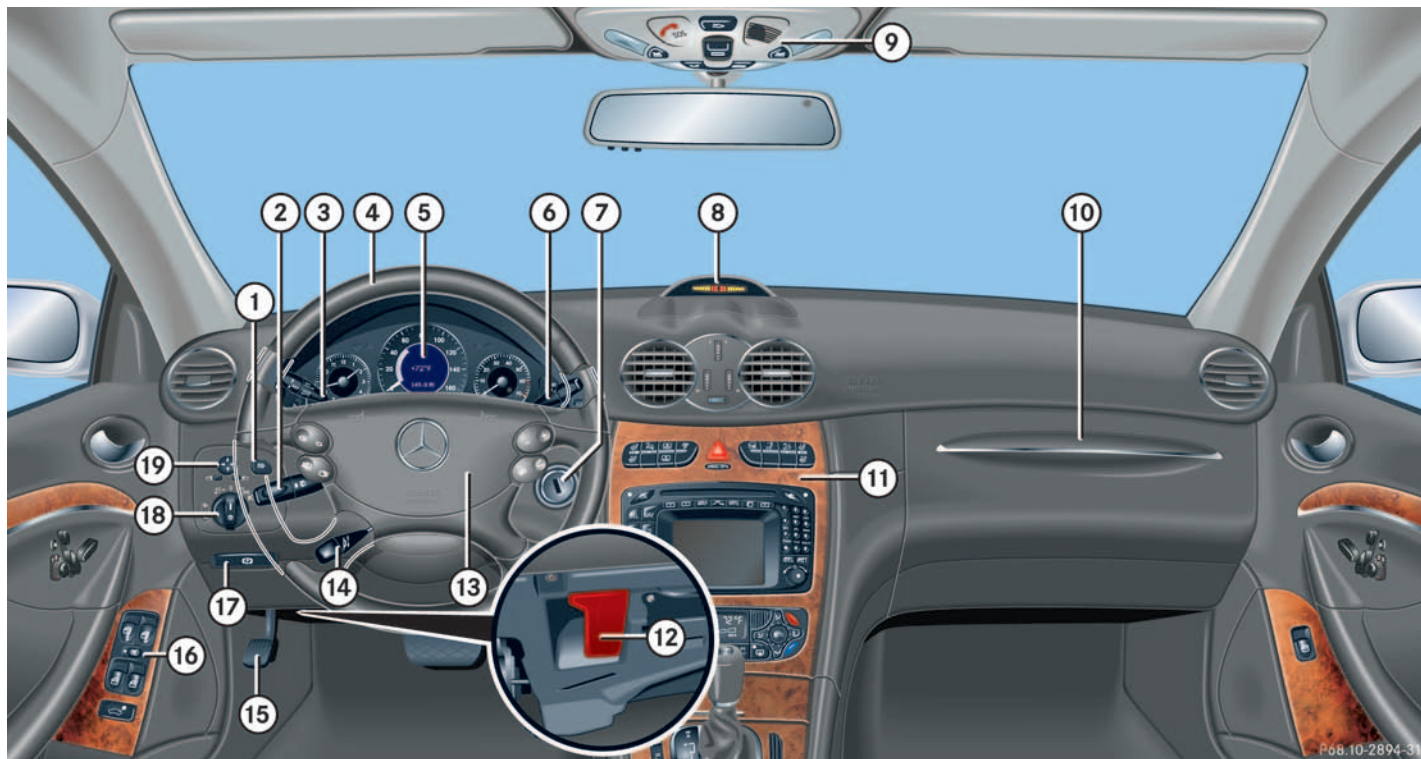

P68.10-2894-31

Item	Page
1 Headlamp washer switch*	151
2 Combination switch	
• Turn signals	47
• High beam	47
• Windshield wipers	47
3 Cruise control lever	
• Cruise control	193
• DISTRONIC*	196
4 Multifunction steering wheel	24, 115
5 Instrument cluster	22, 111
6 Lever for voice control system*, see separate operating instructions	
7 Starter switch	31
8 Front Parktronic* warning indicator	210
9 Overhead control panel	27

Item	Page
10 Glove box	219
11 Center console	25, 26
12 Hood lock release	253
13 Horn	
14 Steering wheel adjustment stalk	37
15 Parking brake pedal	45
16 Door control panel	28
17 Parking brake release	45
18 Exterior lamp switch	46, 105
19 Exterior rear view mirror adjustment	38



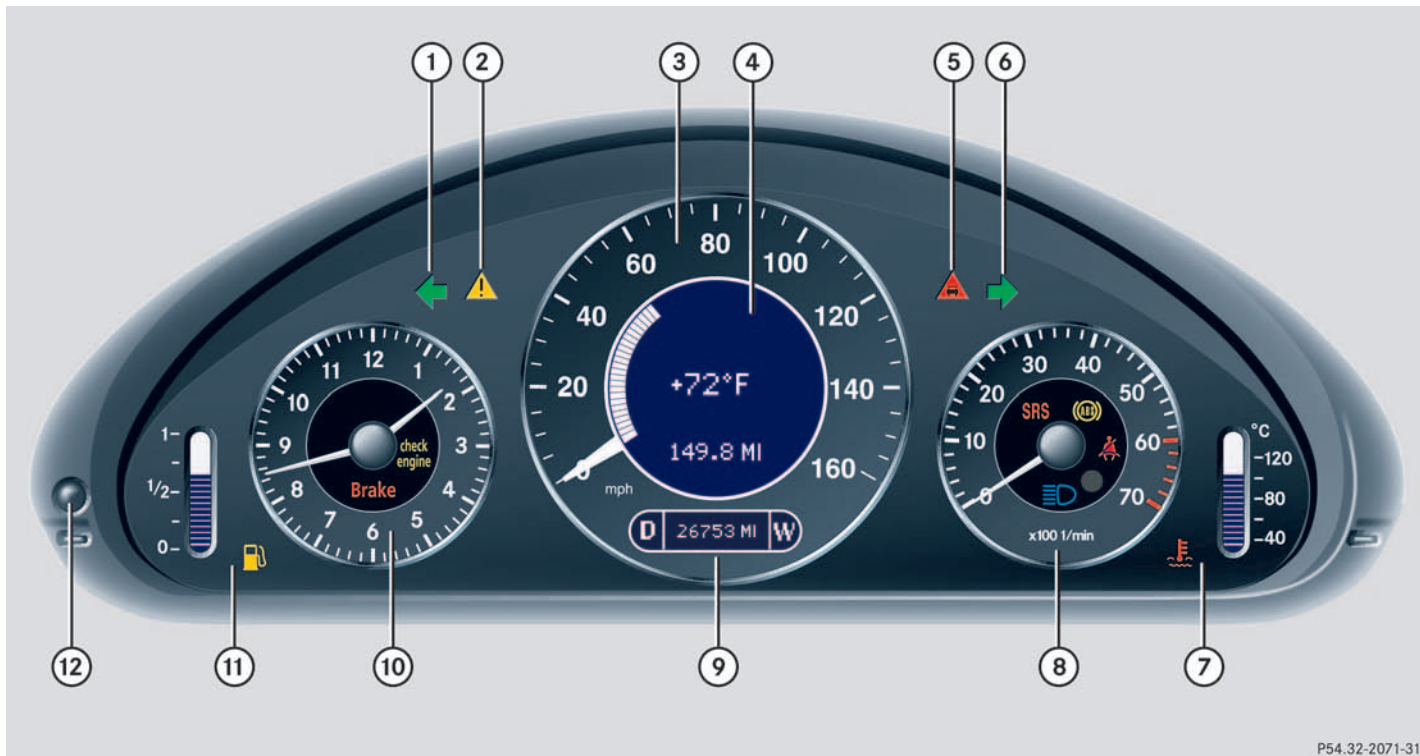

At a glance

Instrument cluster





Instrument cluster







P54.32-2071-31

Item	Page
1  Left turn signal indicator lamp	47
2  Electronic Stability Program (ESP) warning lamp	276
3 Speedometer	
4 Multifunction display with:	114
Basic display with outside temperature display	119, 128
Status indicator with malfunction warning message	119, 122
Trip odometer	112
5  Distance warning lamp ¹	277
6  Right turn signal indicator lamp	47

¹ Vehicles without DISTRONIC*: Warning lamp without function. It illuminates with key in starter switch position 2. It should go out when the engine is running.





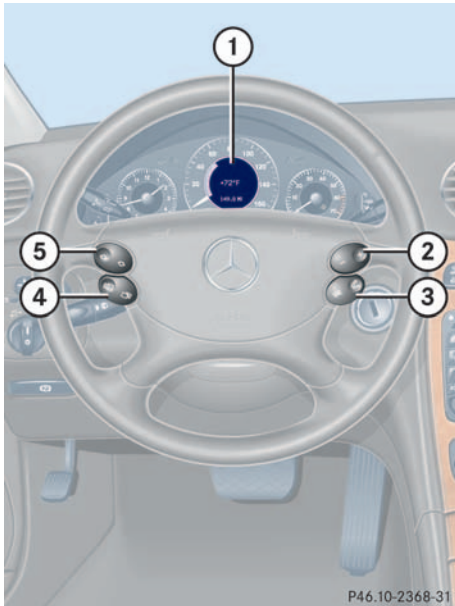

Item	Page
7 Coolant temperature display with:	112
 Coolant temperature warning lamp	281, 290
8 Tachometer with:	113
 Supplemental restraint system indicator lamp	278, 303
 Antilock Brake System (ABS) malfunction indicator lamp	277
 Seat belt nonusage warning lamp	280, 299
 High beam headlamp indicator	108
9 Main odometer with:	
• Selector lever position	114
• Program mode	114





Item	Page
10 Clock with:	128
 Brake warning lamp, except Canada	279
 Brake warning lamp, Canada only	
 Engine malfunction indicator lamp	280
11 Fuel display with:	
 Fuel reserve warning lamp	280
12 Reset knob for:	
• Resetting trip odometer	111
• Instrument cluster illumination	111
• Confirming new time settings	128

Multifunction steering wheel Multifunction steering wheel



P46.10-2368-31

	Item	Page
1	Multifunction display	114
	Operating control system	115
2	Selecting the submenu or setting the volume	
	 down / to decrease	
	 up / to increase	
3	Telephone*: Press button	
	 to take a call	139
	 to dial a call	139
	 to end a call	139
	 to reject an incoming call	

	Item	Page
4	Menu systems: Press button	
	 for next system	
	 for previous system	
5	Moving within a menu: Press button	
	 for next display	
	 for previous display	

Center console

Upper part

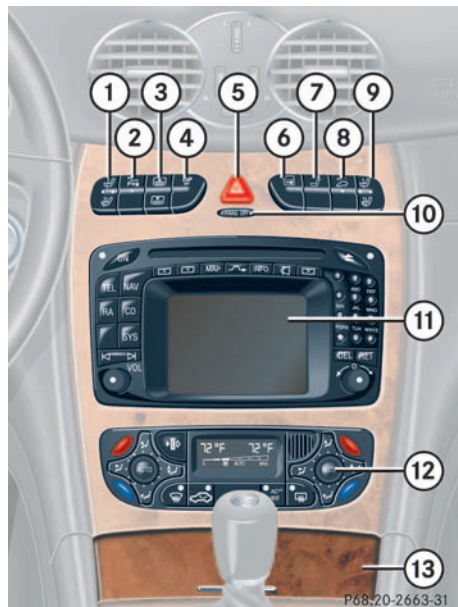

Item	Page
1 Seat heater*, driver's side	101
2 Parking assist* (Parktronic system*) deactivation switch	211
3 Rear window sunshade*	153
4 ESP control switch	76
5 Hazard warning flasher on/off switch	108
6 Central locking switch	96
7 Rear head restraints, folding down switch	98

Item	Page
8 Tow-away alarm switch	81
Anti-theft alarm system indicator lamp	81
9 Seat heater*, passenger side	101
10 Indicator lamp 	68, 282
11 Audio system or COMAND* (see separate operating instructions)	119
12 Automatic climate control	154,
Rear window defroster	162
13 Ashtray	223

Center console

Lower part

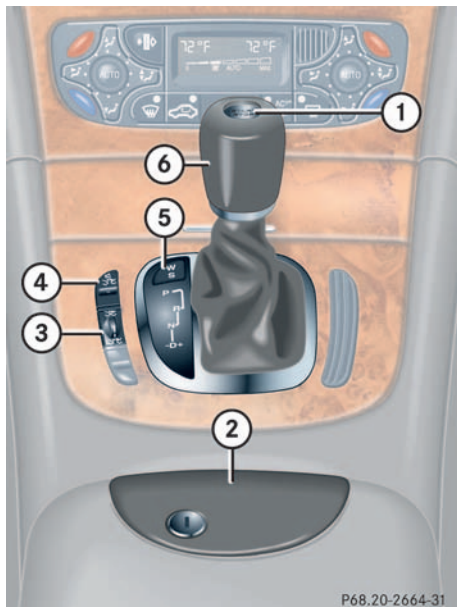

	Item	Page
1	KEYLESS-GO* start/stop button	33
2	Storage compartment	221
3	Thumbwheel for setting distance in DISTRONIC*	203
4	Distance warning function* on/off switch	204

	Item	Page
5	Program mode selector for automatic transmission	145, 147
6	Selector lever for automatic transmission	141

Overhead control panel

Overhead control panel

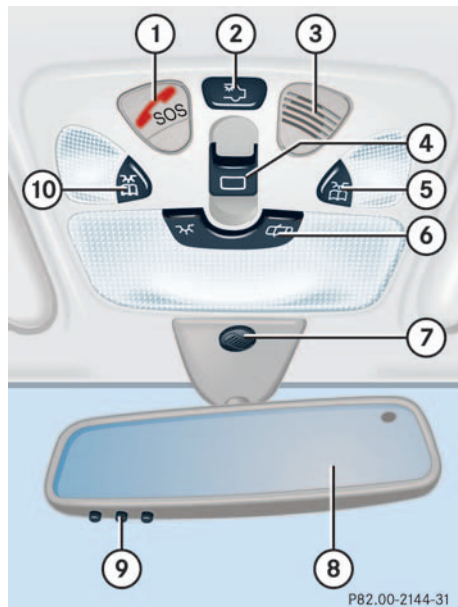

	Item	Page
1	Tele Aid (emergency call system) button	227
2	Rear interior lighting on/off	110
3	Temperature sensor for automatic climate control	154
4	Sliding/pop-up roof*	190
5	Right reading lamp on/off	110
6	Interior lighting control	109

	Item	Page
7	Hands-free microphone for Tele Aid (emergency call system), telephone* and voice control system* (see separate operating instructions)	226
8	Rear view mirror	38, 149
9	Garage door opener	235
10	Left reading lamp on/off	110

Door control panel

Door control panel

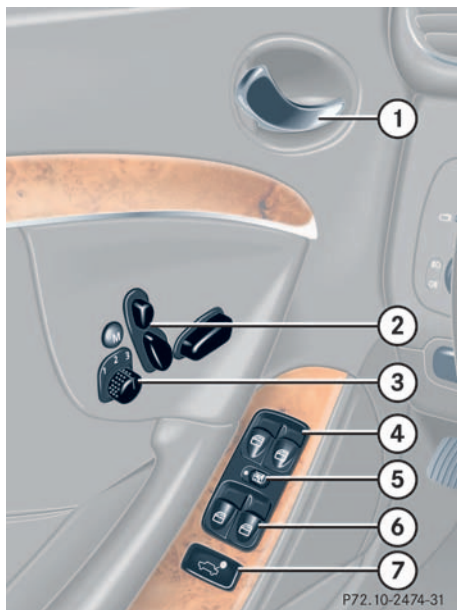

	Item	Page
1	Door handle	92
2	Seat adjustment	35, 97
3	Memory function (for storing seat, mirror and steering wheel settings)	102
4	Switches for opening/closing front door windows	188
5	Rear window override switch	72
6	Switches for opening/closing rear windows	188
7	Remote trunk lid release switch	92

Getting started

Unlocking

Adjusting

Driving

Parking and locking



Unlocking

The “Getting started” section provides an overview of the vehicle’s most basic functions. First-time Mercedes-Benz owners should pay special attention to the information given here.



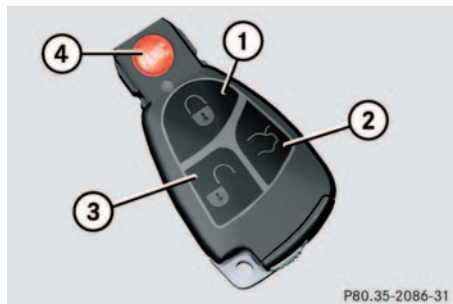

If you are already familiar with the basic functions described here, the “Controls in detail” section will help you with further information. The corresponding page references are at the end of each segment.

Unlocking

Unlocking with the SmartKey



SmartKey with remote control

- 1  Lock button
- 2  Unlock button for trunk lid
- 3  Unlock button
- 4  Panic button (▷ page 73)

- ▶ Press unlock button  on the key.

All turn signal lamps blink once. The locking knobs in the doors move up.

- ▶ Get in the vehicle and insert the key in the starter switch.



Opening a door causes the windows on that side of the car to open slightly. They will return to the up position when the door is closed.

Starter switch positions

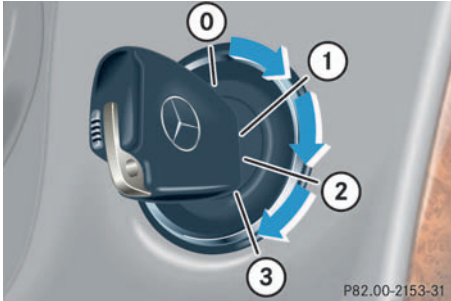

Starter switch

- 0** For removing key
- 1** Power supplies to some electrical consumers, such as seat adjustment
- 2** Ignition (power supply for all electrical consumers) and driving position
- 3** Starting position

Warning!



When leaving the vehicle always remove the key from the starter switch, take the SmartKey with KEYLESS-GO* (if so equipped) with you and lock the vehicle. Do not leave children unattended in the vehicle, or with access to an unlocked vehicle. Unsupervised use of vehicle equipment may cause an accident and/or serious personal injury.



The SmartKey can only be removed from the starter switch with the gear selector lever in position **P**.



If the key is left in starter switch position **0** for an extended period of time, it can no longer be turned in the starter switch.

- ▶ Remove the key from the starter switch and reinsert.

If the key can still not be turned, the battery may not be sufficiently charged.

- ▶ Check the battery and charge it if necessary (▶ page 329).
- ▶ Get a jump start (▶ page 332).

To prevent accelerated battery discharge and a possible dead battery, always remove the key from the starter switch.

Unlocking

Unlocking with KEYLESS-GO*

Your vehicle comes supplied with two SmartKeys with remote controls and a removable mechanical key. The locking tabs for the mechanical key portion of the two keys are a different color to help distinguish each key unit.

The function of the SmartKey overrules the KEYLESS-GO function.

If you have the KEYLESS-GO function, your vehicle checks whether the SmartKey with KEYLESS-GO is valid when you grasp the door handle. If your key is valid, the doors will unlock, and you can open them.



To unlock the vehicle, the SmartKey with KEYLESS-GO must be outside the vehicle, no further than approx. 3 feet (1 meter) away from the door.

- ▶ Grasp the door handle.

The turn signal lamps blink once. The locking knobs on the doors move up.

Pressing the KEYLESS-GO start/stop button on the selector lever corresponds to turning the key to the various starter switch positions.

Warning!



When leaving the vehicle, always take the key and the SmartKey with KEYLESS-GO with you, and lock the vehicle. Do not leave children unattended in the vehicle, or with access to an unlocked vehicle. Unsupervised use of vehicle equipment may cause an accident and/or serious personal injury.



1 KEYLESS-GO start/stop button

Before you press the KEYLESS-GO start/stop button, the vehicle's on-board electronics have status **0** (as with key removed).

Make sure the gear selector lever is set to **P**.

Do not depress the brake pedal.

Position 1

- ▶ Press the KEYLESS-GO start/stop button once.

This supplies power to some electrical consumers, such as seat adjustment.



If you now press the KEYLESS-GO start/stop button twice, the power supply is again switched off.

Ignition (or position 2)

- ▶ Press the KEYLESS-GO start/stop button twice.

This supplies power to all electrical consumers. All the lights in the instrument cluster light up.



If you now press the KEYLESS-GO start/stop button once, the power supply is again switched off.

More information can be found in the “Controls in detail” section (▶ page 88). For information on starting the engine using the KEYLESS-GO start/stop button, see “Starting with KEYLESS-GO*” (▶ page 44).

Adjusting Adjusting

Warning!



All seat, head restraint, steering wheel, and rear view mirror adjustments, as well as fastening of seat belts, must be done before the vehicle is put into motion.

Seats

Warning!



Do not adjust the driver's seat while driving. Adjusting the seat while driving could cause the driver to lose control of the vehicle.

Never ride in a moving vehicle with the seat back reclined. Sitting in an excessively reclined position can be dangerous. You could slide under the seat belt in a collision. If you slide under it, the belt would apply force at the abdomen or neck. That could cause serious or fatal injuries. The seat back and seat belts provide the best restraint when the wearer is in an upright position and belts are properly positioned on the body.

Your seat must be adjusted so that you can correctly fasten your seat belt.

Never place hands under the seat or near any moving parts while a seat is being adjusted.

Warning!



When leaving the vehicle always remove the key from the starter switch, take the Smart-Key with KEYLESS-GO* (if so equipped) with you, and lock your vehicle.

The power seats can also be operated with the driver's or passenger door open. Do not leave children unattended in the vehicle, or with access to an unlocked vehicle. Unsupervised use of vehicle equipment may cause an accident and/or serious personal injury.

Warning!



Children 12 years old and under must never ride in the front seat, except in a Mercedes-Benz authorized BabySmart™ compatible child seat, which operates with the BabySmart™ system installed in the vehicle to deactivate the passenger front airbag when it is properly installed. Otherwise they will be struck by the airbag when it inflates in a crash. If this happens, serious or fatal injury will result.

According to accident statistics, children are safer when properly restrained in the rear seating positions than in the front seating positions. Infants and small children must ride in back seats and be seated in an appropriate infant or child restraint system, which is properly secured with the vehicle's seat belt and top tether strap, or secured via lower anchors and top tether strap, fully in accordance with the child seat manufacturer's instructions.

A child's risk of serious or fatal injuries is significantly increased if the child restraints are not properly secured in the vehicle and the child is not properly secured in the child restraint.

Seat adjustment

The seat adjustment switches are located in each door.

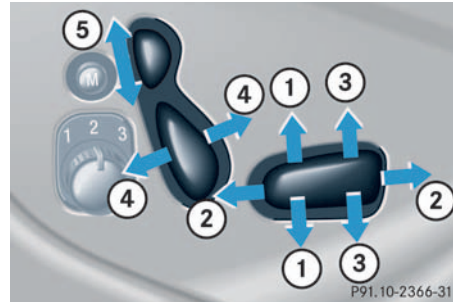

- 1 Seat height
- 2 Seat fore and aft adjustment
- 3 Seat cushion tilt
- 4 Backrest tilt
- 5 Head restraint height

- ▶ Turn the key in the starter switch to position 1 or 2.
or
- ▶ Press the KEYLESS GO* start/stop button once or twice.
or

- ▶ Open the driver's or passenger door.

Seat height

- ▶ Press the switch up or down in the direction of arrow 1.

Seat fore and aft adjustment

- ▶ Press the switch forward or backward in the direction of arrow 2.

Adjust to a comfortable seating position that still allows you to reach the accelerator / brake pedal safely. The position should be as far to the rear as possible, consistent with ability to properly operate controls.



When moving the seat, be sure that there are no items in the footwell or behind the seats. Otherwise you could damage the seats.

Adjusting

Seat cushion tilt

- ▶ Press the switch up or down in the direction of arrow **3** until your upper legs are lightly supported.

Backrest tilt

- ▶ Press the switch forward or backward in the direction of arrow **4** until your arms are slightly angled when holding the steering wheel.

Head restraint height

Warning!



For your protection, drive only with properly positioned head restraints.

Adjust head restraint to support the back of the head approximately at ear level.

Do not drive the vehicle without the seat head restraints. Head restraints are intended to help reduce injuries during an accident.

- ▶ Press the switch up or down in the direction of arrow **5**.



The memory function (▶ page 102) lets you store the steering wheel setting together with the setting for the seat and the exterior rear view mirrors.

Head restraint tilt

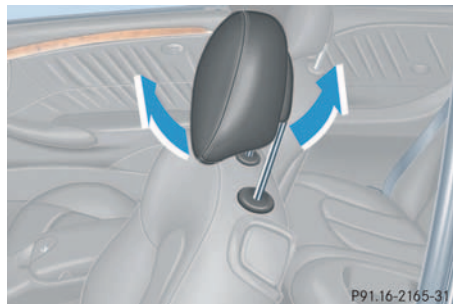

- ▶ Manually adjust the angle of the head restraint. Push or pull on the lower edge of the head restraint cushion.

Folding forward front seat backrests

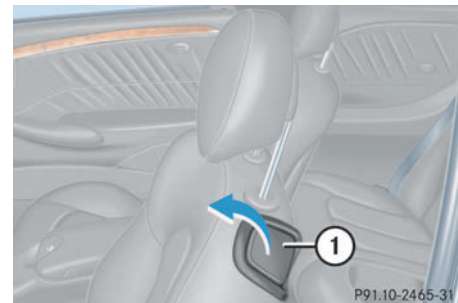

1 Release lever



In addition to the front seat backrests, the front seat cushions can also be shifted forward to permit easy access to the rear whenever the seat is located in the rear half of its adjustment range. Swivel backrest forward by pulling the release lever until the seat moves in a combined forward and upward motion.

Folding backrests forward

- ▶ Pull the release lever forward and swing the backrest to the front.



The head restraint is automatically lowered.

Folding backrests to the rear

- ▶ Fold back and push the backrest until the seat cushion and backrest audibly engage into the driving position.

More information can be found in the “Controls in detail” section (▷ page 97).

Steering wheel**Warning!**

Do not adjust the steering wheel while driving. Adjusting the steering wheel while driving could cause the driver to lose control of the vehicle.

When leaving the vehicle always remove the key from the starter switch, take the Smart-Key with KEYLESS-GO* (if so equipped) with you and lock your vehicle.

The electrical steering wheel adjustment feature can also be operated with the driver's door open. Do not leave children unattended in the vehicle, or with access to an unlocked vehicle. Unsupervised use of vehicle equipment may cause an accident and/or serious personal injury.

Steering wheel adjustment

The stalk is located on the steering column (lower left).

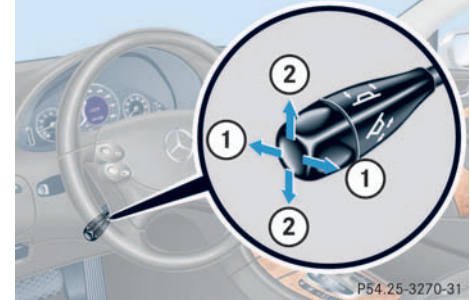

- 1 Steering column, lengthen or shorten
- 2 Steering column, height

- ▶ Turn the key in the starter switch to position **1** or **2**.
or
- ▶ Press the KEYLESS GO* start/stop button once or twice.
or
- ▶ Open the driver's door.

Adjusting

Steering column, lengthen or shorten

- ▶ Move stalk forward or back in the direction of arrow **1** until a comfortable steering wheel position is reached with your arms slightly bent at the elbow.

Steering column, height

- ▶ Move the stalk up or down in the direction of arrow **2**. Make sure that your legs can move freely and that all the displays (including malfunction and indicator lamps) on the instrument cluster are clearly visible.



The memory function (▷ page 102) lets you store the steering wheel setting together with the setting for the seat and the exterior rear view mirrors.

Mirrors

Adjust the inside and exterior rear view mirrors before driving so that you have a good view of the road and traffic conditions.

Warning!



In the case of an accident, liquid electrolyte may escape the mirror housing if the mirror glass breaks.

Electrolyte has an irritating effect. Do not allow the liquid to come into contact with eyes, skin, clothing, or respiratory system. In case it does, immediately flush affected area with water, and seek medical help if necessary.

Inside rear view mirror

- ▶ Manually adjust the inside rear view mirror.

Exterior rear view mirror

Warning!



Exercise care when using the passenger side exterior rear view mirror. The mirror surface is convex (outwardly curved surface for a wider field of view). Objects in mirror are closer than they appear. Check your inside rear view mirror or glance over your shoulder before changing lanes.



Electrolyte drops coming into contact with the vehicle paint finish can only be completely removed while in their liquid state and by applying plenty of water

The buttons are located above the exterior lamp switch.

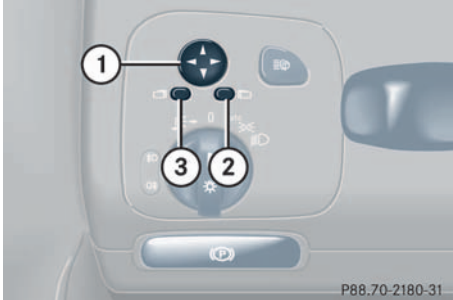

- 1** Adjustment button
- 2** Passenger side mirror
- 3** Driver's side mirror

- ▶ Make sure that the ignition is switched on.
All the lights in the instrument cluster light up.
- ▶ Press button **3** for the left mirror or button **2** for the right mirror.
- ▶ Push adjustment button **1** up, down, left or right according to the setting desired.



If an exterior rear view mirror housing is forcibly pushed forward or backward, reposition it by applying firm pressure until it snaps into place. The mirror housing is now properly positioned and you can adjust the mirror normally.



At low ambient temperatures, the mirrors will be heated automatically.



The memory function (▷ page 102) lets you store the steering wheel setting together with the setting for the seat and the exterior rear view mirrors.

More information can be found in the “Controls in detail” section (▷ page 149).

Driving Driving

Warning!



Do not lay any objects in the driver's footwell. Be careful that floor mats or carpets in the driver's footwell have sufficient clearance for the pedals.

During sudden driving or braking maneuvers, the objects could get caught between the pedals. You could then no longer brake or accelerate.

Fastening the seat belts

Warning!



Always fasten your seat belt before driving off. Always make sure your passengers are properly restrained, even those sitting in the rear and pregnant women.

Failure to wear and properly fasten and position your seat belt greatly increases your risk of injuries and their likely severity in an accident. You and your passengers should always wear seat belts.

If you are ever in an accident, your injuries can be considerably more severe without your seat belt properly buckled. Without your seat belt buckled, you are much more likely to hit the interior of the vehicle or be ejected from it. You can be seriously injured or killed.

In the same crash, the possibility of injury or death is lessened if you are wearing your seat belt. The airbags can only protect as expected if the occupants are using their seat belts (> page 56).

Warning!



Children 12 years old and under must never ride in the front seat, except in a Mercedes-Benz authorized BabySmart™ compatible child seat, which operates with the BabySmart™ system installed in the vehicle to deactivate the passenger front airbag when it is properly installed. Otherwise they will be struck by the airbag when it inflates in a crash. If this happens, serious or fatal injury will result.

According to accident statistics, children are safer when properly restrained in the rear seating positions than in the front seating positions. Infants and small children must ride in back seats and be seated in an appropriate infant or child restraint system, which is properly secured with the vehicle's seat belt and top tether strap, or secured via lower anchors and top tether strap, fully in accordance with the child seat manufacturer's instructions.

A child's risk of serious or fatal injuries is significantly increased if the child restraints are not properly secured in the vehicle and the child is not properly secured in the child restraint.

Warning!

Never let more people ride in the vehicle than there are seat belts available. Be sure everyone riding in the vehicle is correctly restrained with a separate seat belt.

Warning!

Never ride in a moving vehicle with the seat backrest reclined. Sitting in an excessively reclined position can be dangerous. You could slide under the seat belt in a collision. If you slide under it, the belt would apply force at the abdomen or neck. This could cause serious or even fatal injuries. The seat backrest and seat belt provide the best restraint when the wearer is in an upright position and the belt is properly positioned on the body.

Warning!

Read and observe the additional warning notices printed in the "Safety and Security" section (▷ page 60).

The seat belt presenter for driver and passenger makes it easier to put on the seat belt.

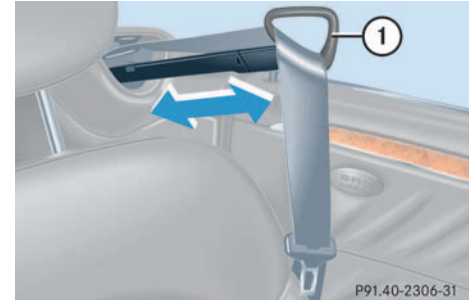
**1** Seat belt presenter

The seat belt presenter slides out when the corresponding door is closed and the key is turned in the starter switch to position **2**.

Driving

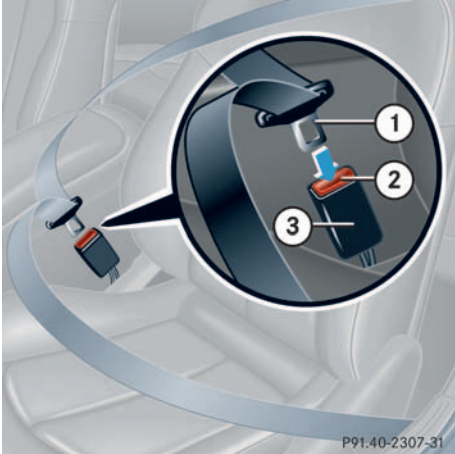

- 1 Latch plate
- 2 Release button
- 3 Buckle

- ▶ With a smooth motion, pull the belt out of the seat belt presenter.
- ▶ Place the belt over your shoulder.
- ▶ Push latch plate **1** into buckle **3** until it clicks.
- ▶ If necessary, tighten the lap portion to a snug fit by pulling shoulder portion up.

Proper use of seat belts

- Do not twist the belt when fastening.
- Adjust seat belt so that the shoulder portion is located as close as possible to the middle of the shoulder (it should not touch the neck or pass under the arm).
- Position the lap belt as low as possible on your hips (over hip joint) and not across the abdomen.
- Place the seat backrest in a nearly upright position.
- Never use a seat belt for more than one person at a time.
- Do not fasten a seat belt around a person and another object at the same time.
- Check your seat belt during travel to ensure that it is properly positioned.
- Ensure that the seat belt is always fitted snugly. You should avoid wearing bulky clothing, such as winter coats, when traveling in the vehicle.

Warning!

Do not pass belts over sharp edges. They could tear.

Do not allow the belt to get caught in the door or in the seat adjustment mechanism. This could damage the belt.

Never attempt to make modifications to seat belts. This could impair the effectiveness of the belts.

Damaged seat belts or belts that were highly stressed in an accident must be replaced by an authorized Mercedes-Benz Center.

Starting the engine**Warning!**

Inhalation of exhaust gas is hazardous to your health. All exhaust gas contains carbon monoxide, and inhaling it can cause unconsciousness and lead to death.

Do not run the engine in confined areas (such as a garage) which are not properly ventilated. If you think that exhaust gas fumes are entering the vehicle while driving, have the cause determined and corrected immediately. If you must drive under these conditions, drive with at least one window fully open.

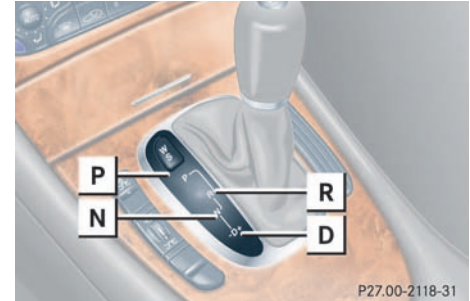
Automatic transmission**Gearshift pattern for automatic transmission**

- P** Park position with selector lever lock
- R** Reverse gear
- N** Neutral
- D** Drive position

- ▶ Make sure that the gear selector lever is set to **P**.

Driving

Starting with the key

- ▶ Turn the key in the starter switch to position **3** and hold until the engine starts (▷ page 31).



You can also use the “touch-start” function. Turn the key to position **3** and release it again immediately. The engine then starts automatically.

- ▶ Depress the brake pedal.

The selector lever lock is released.

For information on turning off the engine with the key, see Turning off engine with the key (▷ page 51).

Starting with KEYLESS-GO*

You can start your vehicle without a key using the KEYLESS-GO start/stop button on the gear selector lever.



1 KEYLESS-GO start/stop button

- ▶ Depress the brake pedal during the starting procedure. Do not depress accelerator.

The selector lever lock is released.

- ▶ Press KEYLESS-GO start/stop button **1** once.

The engine starts automatically if the SmartKey with KEYLESS-GO is in the vehicle.

For information on turning off the engine with KEYLESS-GO, see “Turning off engine with KEYLESS-GO*” (▷ page 52).

Starting difficulties

If the engine does not start as described, carry out the following steps:

- ▶ If you are starting the engine with the key, turn key in starter switch to position **0** and repeat starting procedure.
- ▶ If you are starting the engine with KEYLESS-GO*: Close any doors that may be open to allow for better detection of the SmartKey with KEYLESS-GO*. Or: Start the engine with the key as radio signals from another source may be interfering with the SmartKey with KEYLESS-GO*.
- ▶ Repeat the starting procedure (▷ page 43). Remember that extended starting attempts can drain the battery.
- ▶ Get a jump start (▷ page 332).

If the engine does not start after several starting attempts, there could be a malfunction in the engine electronics or in the fuel supply system.

- ▶ Notify an authorized Mercedes-Benz Center.

Parking brake

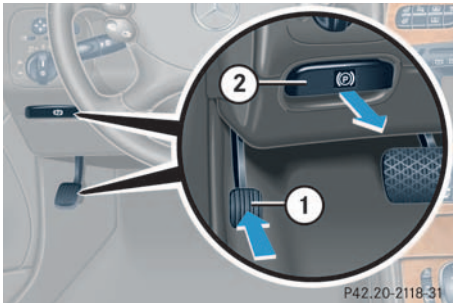

- 1 Parking brake pedal
- 2 Parking brake release handle

Warning!



When leaving the vehicle always remove the key from the starter switch, take the SmartKey with KEYLESS-GO* (if so equipped) with you and lock the vehicle. Do not leave children unattended in the vehicle, or with access to an unlocked vehicle. Children could release the parking brake, which could result in an accident and/or serious personal injury.

- ▶ Release the parking brake by pulling on handle **2**.

The indicator lamp **BRAKE** (USA only) or  (Canada only) in the clock goes out.

Driving

- ▶ Depress the brake pedal.
- ▶ Move selector lever in position **D** or **R**.
- ▶ Release the brake pedal.
- ▶ Carefully depress the accelerator pedal.

Once the vehicle is in motion, the automatic central locking system engages and the locking knobs drop down.



You can open a locked door from the inside. Open door only when conditions are safe to do so.



If you hear a warning signal when driving off, you have forgotten to release the parking brake.

Release the parking brake.

Driving

After a cold start, the automatic transmission engages at a higher revolution. This allows the catalytic converter to reach its operating temperature earlier.



Wait for the gear selection process to complete before setting the vehicle in motion.

Warning!



It is dangerous to shift the selector lever out of **P** or **N** if the engine speed is higher than idle speed. If your foot is not firmly on the brake pedal, the vehicle could accelerate quickly forward or in reverse. You could lose control of the vehicle and hit someone or something. Only shift into gear when the engine is idling normally and when your right foot is firmly on the brake pedal.



Simultaneously depressing the accelerator pedal and applying the brake reduces engine performance and causes premature brake and drivetrain wear.

Warning!



On slippery road surfaces, never downshift in order to obtain braking action. This could result in drive wheel slip and reduced vehicle control. Your vehicle's ABS will not prevent this type of loss of control.

Switching on headlamps



Exterior lamp switch

- 1 Off
- 2 Low beam headlamps on

► Turn the switch to .

More information can be found in the “Controls in detail” section (► page 105).

Turn signals and high beam

The combination switch is on the left of the steering column.

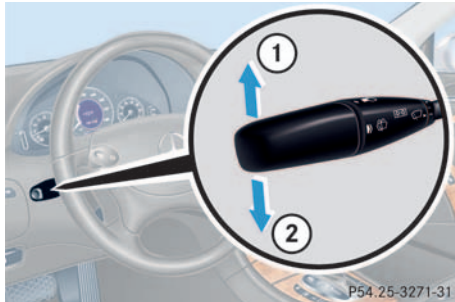

Combination switch

- 1 Turn signals, right
- 2 Turn signals, left

- ▶ Press the combination switch up **1** or down **2**.



To signal minor directional changes, move combination switch to point of resistance only and release. The turn signal blinks three times.

High beam

- ▶ Push the combination switch forward.
- The high beam headlights are switched on.
The high beam symbol  in the tachometer lights up.

More information can be found in the "Controls in detail" section (▶ page 108).

Windshield wipers

The combination switch is on the left of the steering column.

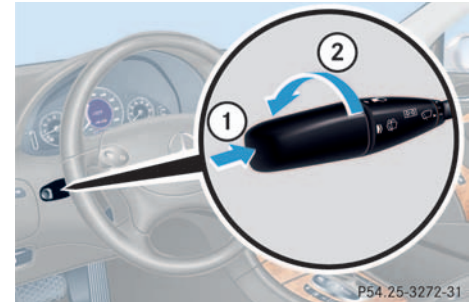

Combination switch

- 1 Single wipe
- 2 Switching on windshield wipers

- ▶ Make sure that the ignition is switched on.

Driving

Switching on windshield wipers

- ▶ Turn the combination switch to the desired position depending on the intensity of the rain.

0 Windshield wipers off

I Intermittent wiping

II Normal wiper speed

III Fast wiper speed



The intermittent wiping interval is dependent on wetness of windshield. Wiping will not occur with a door open.



Do not leave windshield wipers in intermittent setting when vehicle is taken to an automatic car wash or during windshield cleaning. Wipers will operate in the presence of water sprayed on the windshield, and wipers may be damaged as a result.

The switch should not be left in intermittent setting as the wipers will wipe the windshield once every time the engine started. Dust that accumulates on the windshield might scratch the glass when wiping occurs on a dry windshield.

Single wipe

- ▶ Press switch briefly in the direction of arrow **1**.

The windshield wipers wipe one time without washer fluid.

Wiping with windshield washer fluid

- ▶ Push switch in the direction of arrow **1** past the resistance point.

The windshield wiper operates with washer fluid.



If leaves, snow, etc. block the windshield wipers, switch off the wipers.

- For safety reasons, withdraw key from starter switch. Remove blockage.
- Turn the windshield wipers on again.

If windshield wipers fail to function at all in switch position **I**,

- Set the combination switch to the next highest wiper speed.
- Have the windshield wipers checked at the nearest authorized Mercedes-Benz Center.

Problems while driving

The engine runs erratically and misfires

- An ignition cable may be damaged.
- The engine electronics may not be operating properly.
- Unburned gasoline may have entered the catalytic converter and damaged it.
- ▶ Give very little gas.
- ▶ Have the problem repaired by an authorized Mercedes-Benz Center as soon as possible.

The coolant temperature is over 248°F (120°C)

The coolant is too hot and is no longer cooling the engine.

- ▶ Stop the vehicle as soon as possible and turn off the engine. Allow engine and coolant to cool.
- ▶ Check the coolant level and add coolant if necessary (▶ page 256).

In case of accident

If the vehicle is leaking gasoline:

- ▶ Do not start the engine under any circumstances.
- ▶ Notify local fire and/or police authorities.

If the extent of the damage cannot be determined:

- ▶ Notify an authorized Mercedes-Benz Center.

If no damage can be determined on the

- major assemblies
- fuel system
- engine mount
- ▶ Start the engine in the usual manner.

Parking and locking

Parking and locking

You have now completed your first drive. You have properly stopped and parked your vehicle. End your drive as follows:

Warning!



Wait until the vehicle is stationary before removing the key from the starter switch. The vehicle cannot be steered when the key is removed.

Warning!



With the engine not running, there is no power assistance for the brake and steering systems. In this case, it is important to keep in mind that a considerably higher degree of effort is necessary to stop or steer the vehicle.

Warning!



Do not park this vehicle in areas where combustible materials such as grass, hay or leaves can come into contact with the hot exhaust system, as these materials could be ignited and cause a vehicle fire.

To reduce the risk of personal injury as a result of inadvertent vehicle movement, before turning off the engine and leaving the vehicle always:

- Keep right foot on brake pedal.
- Firmly depress parking brake pedal.
- Move the selector lever to position **P**.
- Slowly release brake pedal.
- When parked on an incline, turn front wheel towards the road curb.
- Turn the key to starter switch position **0** and remove, or press start/stop button (vehicles with KEYLESS-GO*).
- Take the key or the SmartKey with KEYLESS-GO* (if so equipped) and lock vehicle when leaving.

Parking brake

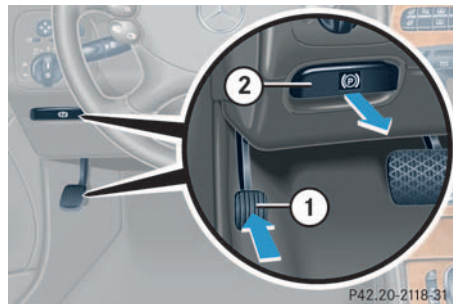

- 1 Parking brake
- 2 Release handle

- ▶ Step firmly on parking brake 1.

When the engine is running, the indicator lamp **BRAKE** (USA only) or **(P)** (Canada only) in the instrument cluster will be illuminated.

Warning!

When leaving the vehicle always remove the key from the starter switch, take the SmartKey with KEYLESS-GO* (if so equipped) with you and lock the vehicle. Do not leave children unattended in the vehicle, or with access to an unlocked vehicle. Children could release the parking brake and/or move the gear selector lever from position **P**, either of which could result in an accident and/or serious personal injury.

Warning!

Getting out of your vehicle with the selector lever not fully engaged in position **P** is dangerous. Also, when parked on an incline, position **P** alone may not prevent your vehicle from moving, possibly hitting people or objects.

Always set the parking brake in addition to shifting to position **P** (▷ page 143).

When parked on an incline, turn front wheels towards the road curb.

Switching off headlamps

- ▶ Turn the exterior lamp switch to **0** (▷ page 46).

More information can be found in the “Controls in detail” section (▷ page 105).

Turning off engine

- ▶ Place the gear selector lever in position **P**.



Always set the parking brake in addition to shifting to position **P**.

On steep slopes, turn the front wheels towards the curb.

Turning off engine with the SmartKey

- ▶ Turn the key in the starter switch (▷ page 31) to position **0** and remove it.
The immobilizer is activated.
- ▶ Press the seat belt release button (▷ page 42).



The SmartKey or the SmartKey with KEYLESS-GO* (if so equipped) can only be removed from the starter switch with the gear selector lever in position **P**.

Parking and locking



With the SmartKey removed and the driver's door open, a warning sounds if the vehicle's exterior lamps are not switched off.

Warning!



To prevent possible personal injury, always keep hands and fingers away from the door openings when closing the doors. Be especially careful when small children are around.

Before closing doors, make sure that there is no possibility of someone getting caught in a door during closing.

- ▶ After exiting the vehicle press the lock button  on the remote control (▷ page 30).

The locking knobs on the doors move down. The turn signal indicators light up briefly.

Warning!



When leaving the vehicle always remove the key from the starter switch and lock your vehicle. Do not leave children unattended in the vehicle, or with access to an unlocked vehicle. Unsupervised use of vehicle may cause an accident and/or serious personal injury.

More information can be found in the "Controls in detail" section (▷ page 84).

Turning off engine with KEYLESS-GO*

- ▶ Place the gear selector lever in **P**.
- ▶ Press the KEYLESS-GO start/stop button until the engine shuts off.

With the driver's door closed, the starter switch is now in position **1**. With the driver's door opened, the starter switch is set to position **0**, same as key removed from starter switch (▷ page 31).

- ▶ Press the seat belt release button (▷ page 42).



If you hear a warning signal you have either

- forgotten to turn off the lights, or
- not put the gear selector lever in **P** before opening the driver's door.

Turn off the lights or place the gear selector lever in **P**.

Warning!

To prevent possible personal injury, always keep hands and fingers away from the door openings when closing the doors. Be especially careful when small children are around.

Before closing doors, make sure that there is no possibility of someone getting caught in a door during closing.

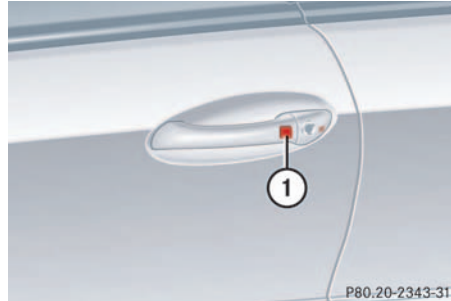

Opening a door causes the windows on that side of the car to open slightly. They will return to the up position when the door is closed.

**1** Lock button on the door handle

- ▶ After exiting the vehicle, press lock button **1** on the door handle or on the trunk lid.

The locking knobs on the doors move down. The turn signal indicators light up briefly.

Warning!

When leaving the vehicle, always remove the key from the starter switch, take the SmartKey with KEYLESS-GO* (if so equipped) with you, and lock your vehicle. Do not leave children unattended in the vehicle, or with access to an unlocked vehicle. Unsupervised use of vehicle equipment may cause an accident and/or serious personal injury.

More information can be found in the “Controls in detail” section (▶ page 84).

Safety and Security

Occupant safety

Panic alarm

Driving safety systems

Anti-theft systems



Occupant safety

In this section you will learn the most important facts about the restraint systems of the vehicle.

The restraint systems are

- Seat belts
- Emergency tensioning device
- Airbags
- Child seats
- Child seat recognition
- Lower anchors and tethers for children (LATCH)

As independent systems their protective effects work in conjunction with each other.



For information on infants and children traveling with you in the vehicle and restraint systems for infants and children, see “Children in the vehicle” (> page 66).

Occupant safety

The **SRS** warning lamp in the instrument cluster lights up:

- for about 4 seconds when you turn the key in the starter switch to position **1** or press the KEYLESS-GO* start/stop button once.
- for about 4 seconds when you start the engine by turning the key or pressing the KEYLESS-GO* start/stop button.



The warning lamp remains lit if the key is turned to position **2** and left there or if the KEYLESS-GO* start/stop button is pressed twice. The warning lamp will go out when you start the engine.

The warning lamp goes out shortly after you start the engine. This shows that the restraint systems are operational.

A malfunction in the system has been detected, if the **SRS** warning lamp:

- fails to extinguish after approximately 4 seconds.
- does not come on at all.
- comes on after the engine was started or while driving.

For safety reasons, we strongly recommend that you visit an authorized Mercedes-Benz Center immediately to have the system checked.

More information can be found in the “Practical hints” section (> page 278).

Warning!

In the event that the SRS malfunction indicator lamp lights up during driving or does not come at all, the SRS may not be operational. For your safety, we strongly recommend that you visit an authorized Mercedes-Benz Center immediately to have the system checked; otherwise the SRS may not be activated when needed in an accident, which could result in serious or fatal injury, or it might deploy unexpectedly and unnecessarily which could also result in injury.

Improper work on the restraint systems, including incorrect installation and removal, can lead to possible injury through an unintended activation of the SRS.

In addition, through improper work there is a risk of rendering the SRS inoperative or causing unintended airbag deployment. Work on the SRS must therefore only be performed by an authorized Mercedes-Benz Center.

Airbags**Warning!**

Airbags are designed to reduce the potential for injury resulting from certain frontal impacts (front airbags) or side impacts (side impact airbags and head protection window curtain airbags) which may cause significant injuries. However, no system available today can totally eliminate injuries and fatalities.

The activation of the SRS temporarily releases a small amount of dust from the airbags. This dust, however, is neither injurious to your health, nor does it indicate a fire in the vehicle. The dust might cause some temporary breathing difficulty for people with asthma or other breathing trouble. To avoid this, you may wish to get out of the vehicle as soon as it is safe to do so. If you have any breathing difficulty but cannot get out of the vehicle after the airbag inflates, then get fresh air by opening a window or door.

Warning!

To reduce the risk of injury when the front airbags inflate, it is very important for the driver and front passenger to always be in a properly seated position and to be wearing seat belts.

For maximum protection in the event of a collision always be in normal seated position with your back against the backrest. Fasten your seat belt and ensure that it is properly positioned on your body.

Since the airbag inflates with considerable speed and force, a proper seating and hands on steering wheel position will help to keep you at a safe distance from the airbag. Occupants who are unbelted, out of position or too close to the airbag can be seriously injured by an airbag as it inflates with great force in the blink of an eye:

- Sit properly belted in an upright position with your back against the seat backrest.

Occupant safety

- Adjust the driver seat as far as possible rearward, still permitting proper operation of vehicle controls. The distance from the center of the driver's breastbone to the center of the airbag cover on the steering wheel must be at least ten inches (25 cm) or more. You should be able to accomplish this by a combination of adjustments to the seat and steering wheel. If you have any problems, please see your authorized Mercedes-Benz Center.
- Do not lean with your head or chest close to the steering wheel or dashboard.
- Keep hands on the outside of steering wheel rim. Placing hands and arms inside the rim can increase the risk and potential severity of hand/arm injury when driver front airbag inflates.
- Adjust the front passenger seat as far as possible rearward from the dashboard when the seat is occupied.

- Occupants, especially children, should never lean their heads in the area of the door where the side airbag inflates. This could result in serious injuries or death should the airbag be triggered. Always sit upright, properly use the seat belts and appropriate size infant or child restraint system.
- Children 12 years old and under must never ride in the front seat, except in a Mercedes-Benz authorized BabySmart™ compatible child seat, which operates with the BabySmart™ system installed in the vehicle to deactivate the passenger front airbag when it is properly installed. Otherwise they will be struck by the airbag when it inflates in a crash. If this happens, serious or fatal injury will result.

Failure to follow these instructions can result in severe injuries to you or other occupants.

If you sell your vehicle you are responsible to make the buyer aware of these points. Be sure to give the buyer this Operator's Manual.

Warning!



Accident research shows that the safest place for children in an automobile is in the rear seat. Should you choose to place a child 12 years old or under in the front passenger seat of your vehicle, you must properly use a BabySmart™ child restraint which will turn off the passenger front airbag. BabySmart™ will not, however, turn off any side impact airbag.

It should be noted that with respect to both front and rear side impact airbags there is a possibility for a side airbag related injury if occupants, especially children, are not properly seated or restrained when next to a side airbag which needs to deploy rapidly in a side impact in order to do its job.

To help avoid the possibility of injury, please follow these guidelines:

- (1) Occupants, especially children, should never place their bodies or lean their heads in the area of the door where the side airbag inflates. This could

result in serious injuries or death should the side airbag be activated.

- (2) Always sit upright, properly use the seat belts and use an appropriately sized infant or child restraint system for all children 12 years old or under.
- (3) Always wear seat belts properly.

If you believe that, even with the use of these guidelines, it would be safer for your rear seat occupants to have the rear mounted side airbags deactivated, then deactivation can be accomplished upon your written request to do so at your authorized Mercedes-Benz Center at an additional cost.

Please contact your local authorized Mercedes-Benz Center or call our Customer Assistance Center at 1-800-FOR-MERCEdes (1-800-367-6372) for details.



Airbags are designed to activate only in certain frontal (front airbags) impacts, or side (side impact and head protection window curtain airbags) impacts which exceed preset thresholds.

Only during these types of impacts, if of sufficient severity to meet the deployment thresholds, will they provide their supplemental protection.

The driver and passenger should always wear their seat belts. Otherwise it is not possible for the airbags to provide their supplemental protection.

In cases of other frontal impacts, angled impacts, roll-overs, other side impacts, rear collisions, or other accidents, the airbags will not be activated. The driver and passengers will then be protected by the fastened seat belts.

We caution you not to rely on the presence of the airbags in order to avoid wearing your seat belt.

Your vehicle was originally equipped with airbags that are designed to activate in certain impacts exceeding a preset threshold to reduce the potential and severity of injury. It is important to your safety and that of your passenger that you replace deployed airbags and repair any malfunctioning airbags to ensure that the vehicle will continue to provide supplemental crash protection for occupants.

Occupant safety

Safety guidelines for the seat belt, emergency tensioning device and airbag

Warning!



- Damaged seat belts or belts that were highly stressed in an accident must be replaced and their anchoring points must also be checked. Only use belts installed or supplied by an authorized Mercedes-Benz Center.
- Airbags and ETDs are designed to function on a one-time-only basis. An airbag or emergency tensioning device (ETD) that was activated must be replaced.
- No modifications of any kind may be made to any components or wiring of the SRS. This includes changing or removing any component or part of the SRS, the installation of additional trim material, badges etc. over the steering wheel hub, front passenger airbag cover, door trim panels, or door frame

trims, and installation of additional electrical/electronic equipment on or near SRS components and wiring. Keep area between airbags and occupants free from objects (e.g. packages, purses, umbrellas, etc.).

- Do not pass belts over sharp edges. They could tear.
- Do not make any modification that could change the effectiveness of the belts.
- Do not hang items such as coat hangers from the coat hooks or handles over the door. These items may turn into projectiles and cause head and other injuries when curtain airbag is deployed.
- An airbag system component within the steering wheel gets hot after the airbag has inflated. Do not touch.
- Improper work on the system, including incorrect installation and removal, can lead to possible injury through an unintended activation of the SRS.

- In addition, through improper work there is a risk of rendering the SRS inoperative or causing unintended airbag deployment. Work on the SRS must therefore only be performed by an authorized Mercedes-Benz Center.
- For your protection and the protection of others, when scrapping the airbag unit or emergency tensioning device, our safety instructions must be followed. These instructions are available from your authorized Mercedes-Benz Center.
- Given the considerable deployment speed and the textile structure of the airbags, there is the possibility of abrasions or other injuries resulting from airbag deployment.

When you sell your vehicle, we strongly urge you to give notice to the subsequent owner that it is equipped with an SRS by alerting them to the applicable section in the Operator's Manual.

Front airbags

Driver and passenger airbags are deployed:

- in the event of a frontal impact
- if impact exceeds a preset deployment threshold
- independently of the side impact airbags

The airbags will not deploy in impacts which do not exceed the system's deployment thresholds. You will then be protected by the fastened seat belts.

The front passenger airbag will only be deployed if:

- the front passenger seat is occupied.
- the  indicator lamp in the center console is not lit (▷ page 68).

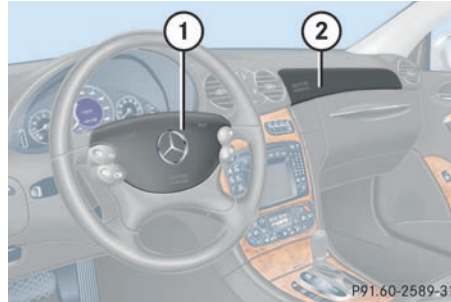

- 1 Driver airbag
- 2 Passenger airbag



Do not place objects heavier than 20 lbs (9 kg) on the front passenger seat. This could cause the front or side impact airbag on the front passenger side to deploy in a crash which exceeds the system's deployment threshold.

Side impact airbags, window curtain airbags

The side impact airbags and window curtain airbags are deployed:

- on the impacted side of the vehicle
- in impacts exceeding a preset deployment threshold
- independently of the front airbags

The side impact airbags **1** and **2** are not deployed in impacts which do not exceed the system's deployment threshold.

The front passenger side impact airbag **1** will only deploy if the system senses that the front passenger seat is occupied.

Occupant safety

The window curtain airbags **3** fill up the area between the A and C pillars (see arrows).

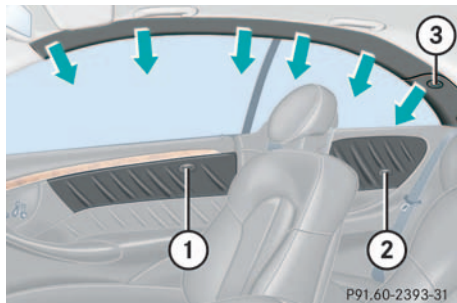

- 1 Front side impact airbags
- 2 Rear side impact airbags
- 3 Window curtain airbag

Seat belts

The seat belt nonusage warning lamp  in the instrument cluster lights up and a warning sounds for a short time when you turn the key in the starter switch to position **2** or press the KEYLESS-GO* (if so equipped) start/stop button twice and the driver's seat belt is not fastened.

After starting the engine the seat belt nonusage warning lamp blinks for a brief period to remind the driver and passengers to fasten the seat belts.

The use of seat belts and infant and child restraint systems is required by law in most states and all Canadian provinces. Even where this is not the case, all vehicle occupants should have their seat belts fastened whenever the vehicle is in motion.

Information on fastening seat belts is found in the “Getting started” section (▷ page 40).



For information on infants and children traveling with you in the vehicle and restraint systems for infants and children, see “Children in the vehicle” (▷ page 66).

Warning!



Always fasten your seat belt before driving off. Always make sure your passengers are properly restrained, even those sitting in the rear and pregnant women.

Failure to wear and properly fasten and position your seat belt greatly increases your risk of injuries and their likely severity in an accident. You and your passengers should always wear seat belts.

If you are ever in an accident, your injuries can be considerably more severe without your seat belt properly buckled. Without your seat belt buckled, you are much more likely to hit the interior of the vehicle or be ejected from it. You can be seriously injured or killed.

In the same crash, the possibility of injury or death is lessened if you are properly wearing your seat belt. Airbags can only protect as they are designed if the occupants are properly wearing their seat belts.

Warning!



Never ride in a moving vehicle with the seat backrest reclined. Sitting in an excessively reclined position can be dangerous. You could slide under the seat belt in a collision. If you slide under it, the belt would apply force at the abdomen or neck. This could cause serious or even fatal injuries. The seat backrest and seat belt provide the best restraint when the wearer is in an upright position and the belt is properly positioned on the body.

Warning!



Never let more people ride in the vehicle than there are seat belts available. Be sure everyone riding in the vehicle is correctly restrained with a separate seat belt.

Warning!



Damaged seat belts or belts that were highly stressed in an accident must be replaced and their anchoring points must also be checked.

Only use seat belts which have been approved by Mercedes-Benz.

Do not make any modifications to the seat belts. This can lead to unintended activation or to failure.

Have all work carried out only by an authorized Mercedes-Benz Center.

Occupant safety

Warning!



USE SEAT BELTS PROPERLY

- Seat belts can only work when used properly. Never wear seat belts in any other way than as described in this section, as that could result in serious injuries in case of an accident.
- Each occupant should wear their seat belt at all times, because seat belts help reduce the likelihood of and potential severity of injuries in accidents, including rollovers. The integrated restraint system includes SRS (driver airbag, front passenger airbag, side impact airbags, head protection window curtain airbags for side windows), ETB (seat belt emergency tensioning device), and front seat knee bolsters. The system is designed to enhance the protection offered to properly belted occupants in certain frontal (front airbags) and side (side impact and window curtain airbags) impacts which exceed preset deployment thresholds.

- Never wear the shoulder belt under your arm, against your neck or off your shoulder. In a crash, your body would move too far forward. That would increase the chance of head and neck injuries. The belt would also apply too much force to the ribs or abdomen, which could severely injure internal organs such as your liver or spleen.
- Never wear belts over rigid or breakable objects in or on your clothing, such as eyeglasses, pens, keys etc., as these might cause injuries.
- Position the lap belt as low as possible on your hips and not across the abdomen. If the belt is positioned across your abdomen, it could cause serious injuries in a crash.

- Never use a seat belt for more than one person at a time. Do not fasten a seat belt around a person and another person or other objects.
- Belts should not be worn twisted. In a crash, you wouldn't have the full width of the belt to manage impact forces. The twisted belt against your body could cause injuries.
- Pregnant women should also use a lap-shoulder belt. The lap belt portion should be positioned as low as possible on the hips to avoid any possible pressure on the abdomen.
- Never place your feet on the instrument panel or on the seat. Always keep both feet on the floor in front of the seat.

Emergency tensioning device (ETD), seat belt force limiter

The seat belts for the front and rear outer seats are equipped with emergency tensioning devices and belt force limiters.

The ETD is designed to activate only when the seat belt is fastened and in the following cases:

- in frontal or rear-end impacts exceeding a preset severity level
- if the restraint systems are operational and functioning correctly. See **SRS** indicator lamp (▷ page 56)

In an impact, emergency tensioning devices remove slack from the belts in such a way that the seat belts fit more snugly against the body. Belt force limiters reduce the force exerted by the seat belts on occupants during a crash.

Warning!



An emergency tensioning device (ETD) that was activated must be replaced.

When scrapping the emergency tensioning device, our safety instructions must be followed. These are available at your authorized Mercedes-Benz Center.



Do not place objects heavier than 20 lbs (9 kg) on the front passenger seat. This could cause the front or side impact airbag on the front passenger side to deploy in a crash which exceeds the system's deployment threshold.

Automatic comfort-fit feature seat belt

An automatic comfort-fit feature for front seats reduces the retracting force of the seat belts when they are in normal use.

Occupant safety

Children in the vehicle

If an infant or child is traveling with you in the vehicle:

- Secure the child using an infant or child restraint appropriate to the age and size of the child and recommended for use by Mercedes-Benz.
- Ensure that the infant or child is properly secured by a belt at all times while the vehicle is in motion.

Infant and child restraint seats and information on choosing an appropriate restraint system can be obtained from any Mercedes-Benz Center.

Infant and child restraint systems

Only use a BabySmart™ compatible child restraint for the front passenger seat in this vehicle.

We recommend all infants and children be properly restrained at all times while the vehicle is in motion.

All lap-shoulder belts except the driver's seat belt have special seat belt retractors for secure fastening of child restraints.

To fasten a child restraint, follow child restraint instructions for mounting. Then pull the shoulder belt out completely and let it retract. During seat belt retraction, a ratcheting sound can be heard to indicate that the special seat belt retractor is activated. The belt is now locked. Push down on child restraint to take up any slack.

To deactivate, release seat belt buckle and let seat belt retract completely. The seat belt can again be used in the usual manner.



Information on child seats with anchor fittings for tether anchorages (▷ page 70).

For information on LATCH-type child seat anchors (▷ page 71).

BabySmart™ is a trademark of Siemens Automotive Corp.

Warning!



Never release the seat belt buckle while the vehicle is in motion, since the special seat belt retractor will be deactivated.



The use of infant or child restraints is required by law in all 50 states, the District of Columbia, the U.S. territories, and all Canadian provinces.

Infants and small children should be seated in an appropriate infant or child restraint system properly secured by a lap-shoulder belt or, if so equipped, a child restraint lower anchorage system that complies with U.S. Federal Motor Vehicle Safety Standards 213 and 225 and Canadian Motor Vehicle Safety Standards 213 and 210.2.

A statement by the child restraint manufacturer of compliance with this standard can be found on the instruction label on the restraint and in the instruction manual provided with the restraint.

When using any infant or child restraint system, be sure to carefully read and follow all manufacturer's instructions for installation and use.

Please read and observe warning labels affixed to inside of vehicle and to infant or child restraints.

Warning!

Children 12 years old and under must never ride in the front seat, except in a Mercedes-Benz authorized BabySmart™ compatible child seat, which operates with the BabySmart™ system installed in the vehicle to deactivate the passenger front airbag when it is properly installed. Otherwise they will be struck by the airbag when it inflates in a crash. If this happens, serious or fatal injury will result.

According to accident statistics, children are safer when properly restrained in the rear seating positions than in the front seating positions. Infants and small children must ride in back seats and be seated in an appropriate infant or child restraint system, which is properly secured with the vehicle's seat belt and top tether strap, or secured via lower anchors and top tether strap, fully in accordance with the child seat manufacturer's instructions.

Infants and small children should never share a seat belt with another occupant. During an accident, they could be crushed between the occupant and seat belt.

Children too big for child restraint systems must ride in back seats using regular seat belts. Position shoulder belt across chest and shoulder, not face or neck. A booster seat may be necessary to achieve proper belt positioning for children over 41 lbs. until they reach a height where a lap/shoulder belt fits properly without a booster.

A child's risk of serious or fatal injuries is significantly increased if the child restraints are not properly secured in the vehicle and the child is not properly secured in the child restraint.

When the child restraint is not in use, remove it from the vehicle or secure it with the seat belt to prevent the child restraint from becoming a projectile in the event of an accident.

Occupant safety

Do not leave children unattended in the vehicle; even if the children are secured in a child restraint system. Unsupervised children in a child restraint system may use vehicle equipment and may cause an accident and/or serious personal injury.

BabySmart™ airbag deactivation system



1 Indicator lamp

Special BabySmart™ compatible child seats, designed for use with the Mercedes-Benz system and available at any authorized Mercedes-Benz Center, are required for use with the BabySmart™ airbag deactivation system. With the special child seat properly installed, the passenger front airbag will not deploy.

The  indicator lamp 1 located in the center console will be illuminated, except with the key removed or in the starter switch position 0.



The system does not deactivate the side impact airbag and the emergency tensioning device.

Self-test BabySmart™ without special child seat installed

After turning the key in the starter switch to position 1 or 2 or pressing the KEYLESS-GO* (if so equipped) start/stop button once or twice, the  indicator lamp 1 located in the center console lights up for approx. 6 seconds and then goes out.

If the indicator lamp should not come on or is continuously lit, the system is not functioning. You must see an authorized Mercedes-Benz Center before seating any child on the passenger seat.

More information can be found in the “Practical hints” section (▷ page 282).

BabySmart™ is a trademark of Siemens Automotive Corp.

Warning!

The BabySmart™ airbag deactivation system will ONLY work with a special child seat designed to operate with it. It will not work with child seats which are not BabySmart™ compatible.

Never place anything between seat cushion and child seat (e.g. pillow), since it reduces the effectiveness of the deactivation system. The bottom of the child seat must make full contact with the passenger seat cushion. An incorrectly mounted child seat could cause injuries to the child in case of an accident, instead of protecting the child.

Follow the manufacturer's instructions for installation of special child seats.

Warning!

When using a BabySmart™ compatible child seat on the front passenger seat, the front passenger airbag will not deploy only if the  indicator lamp remains illuminated.

Please be sure to check the indicator every time you use the special system child seat. Should the light go out while the restraint is installed, please check installation. If the light remains out, do not use the BabySmart™ restraint to transport children on the front passenger seat until the system has been repaired.

Warning!

Do not place powered-on laptops, cell phones and like electronic devices on the front passenger seat. Signals from such devices may interfere with the BabySmart™ system. Such signal interference may cause the  indicator lamp not to come on during self-test or be continuously lit, indicating that the system is not functioning.

Occupant safety

Installation of infant and child restraint systems

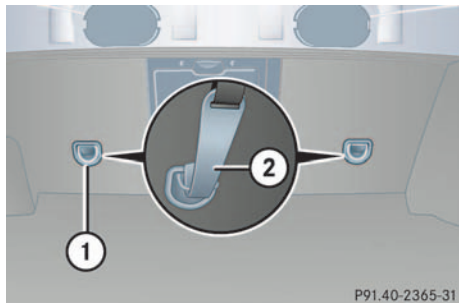

1 Anchorage ring

2 Hook

Anchorage rings **1** are located on the rear side of outer rear backrests.

Prior to installing a tether strap, note the following steps:

- ▶ Open the trunk and release the backrest.
- ▶ Fold backrest forward.
- ▶ Guide top tether strap between head restraint and top of seat back.

Head restraint must be installed and positioned such that the top tether strap can pass freely between the head restraint and the top of seat back.

Make sure that the tether strap is not twisted.

- ▶ Fold backrest back until it locks in place.

Warning!



Always lock backrest in its upright position when rear seat bench is occupied by passengers, or the extended cargo area is not in use. Check for secure locking by pushing and pulling on the backrest.

- ▶ Fold up anchorage ring **1**.
- ▶ Securely fasten hook **2**, which is part of the tether strap, to anchorage ring **1**.



For safety, please make sure that the hook has attached to the ring beyond the safety catch.

Child seat anchors – “LATCH” type

This vehicle is equipped with two “LATCH” (Lower Anchors and Tethers for Children) type anchors (at each of the outer rear seats) for the installation of a “LATCH” child seat with matching anchor fittings.

If child seats are not installed, the “LATCH” anchors can be folded back between the seat cushion and the seat backrest.

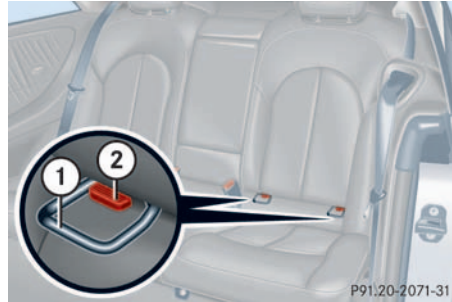

- ▶ Grip inner side of anchors **1** and fold forward until they lock in place.
- ▶ Install child seat according to the manufacturer’s instructions.



The child seat must be firmly attached in the right and left side anchors.

To fold anchors back

- ▶ Press down button **2** on each anchor and return the anchor to its catch.



Non-“LATCH” type child seats may also be used and can be installed using the vehicle’s seat belt system. Install child seat according to the manufacturer’s instructions.

Warning!



Children too big for child restraint systems must ride in back seats using regular seat belts. Position shoulder belt across chest and shoulder, not face or neck. A booster seat may be necessary to achieve proper belt positioning for children over 41 lbs. until they reach a height where a lap/shoulder belt fits properly without a booster.

Occupant safety

Before installing the child seat, make sure anchors **1** are folded out and locked in place.

Install child seat according to manufacturer's instructions.

The child seat must be firmly attached in the right and left side anchor **1**.

An incorrectly mounted child seat may come loose during an accident which could result in serious injury or death to your child.

Damaged or impact damaged child seats or child seat anchor fittings must be replaced.

Do not leave children unattended in the vehicle, even if the children are secured in a child restraint system.

Blocking of rear side window operation

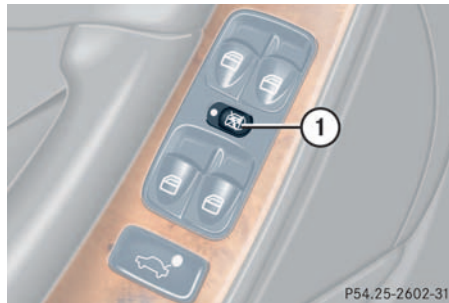

1 Override switch

- ▶ Slide override switch **1** to the right.

The rear side windows can no longer be operated using the switches located in the rear trim panel.



Operation of the rear side windows with the switches located in the driver's door is still possible.

Warning!



Activate the override switch when children are riding in the back seats of the vehicle. The children may otherwise injure themselves, e.g. by becoming trapped in the window opening.

Panic alarm

An audible alarm and blinking exterior lamps will operate for approximately 2½ minutes.

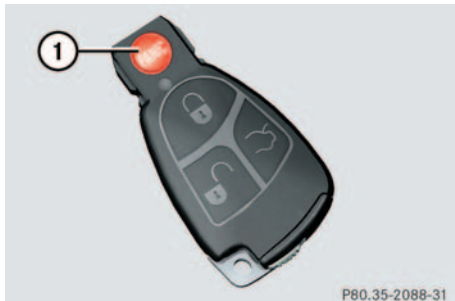

1 **PANIC** button

Activating

- ▶ Press and hold button 1 for at least one second.

Deactivating

- ▶ Press button 1 again
- or
- ▶ Insert key in starter switch.



For operation in the USA only: This device complies with Part 15 of the FCC Rules. Operation is subject to the following two conditions:

- (1) This device may not cause harmful interference, and
- (2) this device must accept any interference received, including interference that may cause undesired operation.

Any unauthorized modification to this device could void the user's authority to operate the equipment.

Driving safety systems

Driving safety systems

In this section you will find information on the following driving safety systems:

- ABS (Antilock Brake System)
- BAS (Brake Assist System)
- ESP (Electronic Stability Program)



In winter operation, the maximum effectiveness of the ABS and the ESP is only achieved with winter tires (M+S tires), or snow chains as required.

Warning!



The following factors increase the risk of accidents:

- Excessive speed, especially in turns
- Wet and slippery road surfaces
- Following another vehicle too closely

The ABS, BAS and ESP cannot reduce this risk.

Always adjust your driving style to the prevailing road and weather conditions.

ABS

Warning!



Do not pump the brake pedal. Use firm, steady brake pedal pressure instead. Pumping the brake pedal defeats the purpose of the ABS and significantly reduces braking effectiveness.

The ABS regulates the brake pressure so that the wheels do not lock during braking. This allows you to maintain the ability to steer your vehicle.

The ABS is functional above a speed of approximately 5 mph (8 km/h) independent of road surface conditions.

At the instant one of the wheels is about to lock up, a slight pulsation can be felt in the brake pedal, indicating that the ABS is in the regulating mode. Keep firm and steady pressure on the brake pedal while experiencing the pulsation.

Continuous steady brake pedal pressure yields the advantages provided by the ABS, namely braking power and the ability to steer the vehicle.

On slippery road surfaces, the ABS will respond even with light brake pressure. The pulsating brake pedal can be an indication of hazardous road conditions and functions as a reminder to take extra care while driving.



To alert following vehicles to slippery road conditions you discover, operate your hazard warning flashers as appropriate.

Warning!



The ABS cannot prevent the natural laws of physics from acting on the vehicle, nor can it increase braking or steering efficiency beyond that afforded by the condition of the vehicle brakes and tires or the traction. The ABS cannot prevent accidents, including those resulting from excessive speed in turns, following another vehicle too closely, or hydroplaning. Only a safe, attentive, and skillful driver can prevent accidents. The capabilities of an ABS equipped vehicle must never be exploited in a reckless or dangerous manner which could jeopardize the user's safety or the safety of others.

ABS control

The warning lamp in the instrument cluster lights up when you turn the key in the starter switch to position **2** or press the KEYLESS-GO* (if so equipped) start/stop button twice. It goes out when the engine is running.

More information can be found in the “Practical hints” section (▷ page 277).

Driving safety systems

BAS

The Brake Assist System (BAS) operates in emergency situations. If you apply the brakes very quickly, the BAS automatically provides full brake boost, thereby potentially reducing the braking distance. Apply continuous full braking pressure until the emergency braking situation is over. The ABS will prevent the wheels from locking.

When you release the brake pedal, the brakes function again as normal. The BAS is then deactivated.

More information can be found in the “Practical hints” section (▷ page 285).

Warning!





The BAS cannot prevent the natural laws of physics from acting on the vehicle, nor can it increase braking efficiency beyond that afforded by the condition of the vehicle brakes and tires or the traction. The BAS cannot prevent accidents, including those resulting from excessive speed in turns, following another vehicle too closely, or hydroplaning. Only a safe, attentive, and skillful driver can prevent accidents. The capabilities of a BAS equipped vehicle must never be exploited in a reckless or dangerous manner which could jeopardize the user's safety or the safety of others.

ESP

The Electronic Stability Program (ESP) monitors the vehicle's traction (force of adhesive friction between the tires and the road surface) and handling.

The ESP recognizes when a wheel is spinning or if the vehicle starts to skid. By applying brakes to the appropriate wheel and by limiting engine output, the ESP works to stabilize the vehicle. The ESP is especially useful while driving off and on wet or slippery road surfaces.

The ESP warning lamp  in the instrument cluster flashes when the ESP is engaged.

The warning lamp  in the instrument cluster lights up when you turn the key in the starter switch to position **2** or press the KEYLESS-GO* (if so equipped) start/stop button twice. It goes out when the engine is running.

Warning!

Never switch off the ESP when you see the ESP warning lamp  flashing in the instrument cluster. In this case proceed as follows:

- While driving off, apply as little throttle as possible
- While driving, ease upon the accelerator
- Adapt your speed and driving style to the prevailing road conditions

Failure to observe these guidelines could cause the vehicle to skid.

The ESP cannot prevent accidents resulting from excessive speed.

Warning!

The ESP cannot prevent the natural laws of physics from acting on the vehicle, nor can it increase the traction afforded. The ESP cannot prevent accidents, including those resulting from excessive speed in turns, or hydroplaning. Only a safe, attentive, and skillful driver can prevent accidents. The capabilities of an ESP equipped vehicle must never be exploited in a reckless or dangerous manner which could jeopardize the user's safety or the safety of others.



Distronic* is switched off when ESP is activated.



Because of the ESP's automatic operation, the engine must be shut off (key in starter switch position **0** or **1**) when

- the parking brake is being tested on a brake test dynamometer.
- the vehicle is being towed with the front/rear axle raised.

Active braking action through the ESP may otherwise seriously damage the rear axle brake system.

The ESP will only function properly if you use wheels of the recommended tire size.

More information can be found in the "Practical hints" section (▷ page 276).

Switching off ESP

Warning!



ESP should not be switched off during normal driving other than in the circumstances described below. Disabling of the system will reduce vehicle stability in standard driving maneuvers.

To improve the vehicle's traction, turn off the ESP in driving situations where it would be advantageous to have the drive wheels spin and thus cut into surfaces for better grip such as:

- starting out on slippery surfaces and in deep snow in conjunction with snow chains
- sand or gravel

The switch is located on the center console.



- 1 ESP off
- 2 ESP on

- ▶ Press upper half **1** of the switch. The ESP warning lamp , located in the instrument cluster, comes on.

ESP is deactivated.

If one or more wheels are spinning, the ESP warning lamp  in the instrument cluster flashes, regardless of the speed.

Traction control brakes a spinning wheel even when ESP is deactivated.

ESP always operates when you are braking, even when it has been deactivated.



Avoid spinning of a drive wheel for an extended period with the ESP switched off. This may cause serious damage to the drivetrain which is not covered by the Mercedes-Benz Limited Warranty.

Warning!



When the ESP warning lamp  is illuminated continuously, the ESP is switched off.

Adapt your speed and driving to the prevailing road conditions and to the non-operating status of the ESP.

Switching on ESP

- ▶ Press lower half **2** of the switch.

The ESP warning lamp  in the instrument cluster goes out. You are now again in normal driving mode.

Anti-theft systems

Immobilizer

The immobilizer prevents unauthorized persons from starting your vehicle.

Activating

- With the key: Removing the key from the starter switch activates the immobilizer.
- With KEYLESS-GO*: Turning off the engine by means of the KEYLESS-GO start/stop button on the gear selector lever activates the immobilizer.

Deactivating

- With the key: Inserting the key in the starter switch deactivates the immobilizer.
- With KEYLESS-GO*: Starting the engine by means of the KEYLESS-GO start/stop button on the gear selector lever deactivates the immobilizer.



In case the engine cannot be started (yet the vehicle's battery is charged), the system is not operational. Contact an authorized Mercedes-Benz Center or call 1-800-FOR-MERCEdes (in the USA), or 1-800-387-0100 (in Canada).

Anti-theft systems

Anti-theft alarm system

Once the alarm system has been armed, a visual and audible alarm is triggered when someone opens

- a door
- the trunk
- the hood.

The alarm system will also be triggered when

- someone attempts to raise the vehicle
- the vehicle is opened with the mechanical key.



If the alarm stays on for more than 20 seconds, an emergency call is initiated automatically by the Tele Aid system provided Tele Aid service was subscribed to and properly activated.

Arming the alarm system

The alarm system is armed after locking the vehicle with the remote control or KEYLESS-GO*. The turn signal lamps blink three times to indicate that the alarm system is activated. The indicator lamp in the switch for the tow-away alarm will blink after approximately 10 seconds when the alarm system is completely armed (▷ page 25).



If the turn signal lamps do not blink three times one of the following elements may not be properly closed:

- a door
- the trunk lid
- the hood

Close the respective element and lock the vehicle again.



Disarming the alarm system

The alarm system is disarmed when you unlock your vehicle with the remote control or KEYLESS-GO*. The turn signal lamps blink once to indicate that the alarm system is deactivated

Canceling the alarm

To cancel the alarm:

With the key

- ▶ Insert the key in the starter switch.
- or
- ▶ Press the  or  button.

*With KEYLESS-GO**

- ▶ Grasp the outside door handle.
- or
- ▶ Press the KEYLESS-GO* start/stop button.

Tow-away alarm

Once the tow-away alarm is armed, a visual and audible alarm will be triggered when someone attempts to raise the vehicle.



The tow-away protection alarm is triggered, for example, if the vehicle is lifted on one side.

If the alarm stays on for more than 20 seconds, an emergency call is initiated automatically by the Tele Aid system provided Tele Aid service was subscribed to and properly activated.

Arming tow-away alarm

When you lock your vehicle, the tow-away alarm is automatically armed after about 30 seconds.

When you unlock your vehicle, the tow-away protection disarms automatically.

Disarming tow-away alarm

To prevent triggering the tow-away alarm feature, switch off the tow-away alarm before towing the vehicle, or when parking on a surface subject to movement, such as a ferry or auto train.



1 Tow-away alarm off switch

2 Indicator lamp

The switch is located on the center console.

- ▶ Turn off the ignition and remove the key.



You cannot disarm the tow-away alarm if the ignition is turned on.

- ▶ Press upper half **1** of the switch.
Indicator lamp **2** in the switch lights up briefly.
- ▶ Lock your vehicle with the key or (vehicles with KEYLESS-GO*) the lock button at each door handle.

The tow-away alarm remains disarmed until you lock your vehicle again.



Controls in detail

Locking and unlocking

Seats

Memory function

Lighting

Instrument cluster

Control system

Automatic transmission

Good visibility

Automatic climate control

Audio system

Power windows

Sliding/pop-up roof*

Driving systems

Loading

Useful features

Locking and unlocking

In the “Controls in detail” section you will find detailed information on how to operate the equipment installed on your vehicle. If you are already familiar with the basic functions of your vehicle, this section will be of particular interest to you.

To quickly familiarize yourself with the basic functions of the vehicle, refer to the “Getting started” section of this manual. The corresponding page numbers are given at the beginning of each segment.

Locking and unlocking

Keys

Your vehicle comes supplied with two SmartKeys with remote controls and a removable mechanical key. The locking tabs for the mechanical key portion of the two keys are a different color to help distinguish each key unit.

The remote control key provides an extended operating range. To prevent theft, however, it is advisable to only unlock the vehicle when you are in close proximity to it.

The key centrally locks and unlocks:

- the doors
- the trunk
- the fuel filler flap

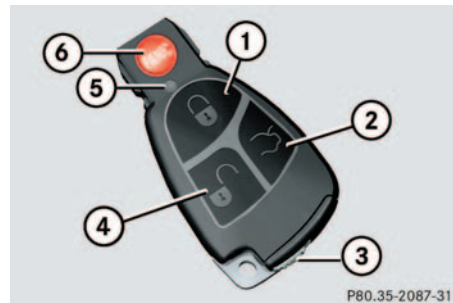

SmartKey with remote controls

- 1 Lock button
- 2 Unlock button for trunk lid
- 3 Mechanical key locking tab
- 4 Unlock button
- 5 Battery check lamp
- 6 **PANIC** Panic button (▷ page 73)



You can also open and close the power windows (▷ page 188) and sliding/pop-up roof (▷ page 191) using the SmartKey.



To prevent possible malfunction, avoid exposing the key to high levels of electromagnetic radiation.

Factory setting

Global unlocking

- ▶ Press button .

All turn signal lamps blink once. The locking knobs in the doors move up.

The vehicle will lock again automatically within approximately 40 seconds of unlocking if neither door nor trunk is opened, if the SmartKey is not inserted in the starter switch, or if the central locking switch is not activated.



Global locking

- ▶ Press button .

All turn signal lamps blink three times. The locking knobs in the doors move down.

Selective setting

If you frequently travel alone, you may wish to reprogram the key so that pressing  only unlocks the driver's door and the fuel filler flap.

- ▶ Press and hold buttons  and  simultaneously for about five seconds until battery check lamp **5** blinks twice.

The key will then function as follows:

Unlocking driver's door and fuel filler flap

- ▶ Press button  once.



Global unlocking

- ▶ Press button  twice.

Global locking

- ▶ Press button .

Restoring to factory setting

- ▶ Press and hold buttons  and  simultaneously for about six seconds until battery check lamp **5** blinks twice.

Warning!



When leaving the vehicle always remove the key from the starter switch, take the SmartKey with KEYLESS-GO* (if so equipped) with you and lock the vehicle. Do not leave children unattended in the vehicle, or with access to an unlocked vehicle. It is possible for children to open a locked door from the inside, which could result in an accident and/or serious personal injury.

Locking and unlocking





If you can no longer lock or unlock the vehicle with the key, then either the batteries in the SmartKey are discharged or the key is malfunctioning.

- Check the batteries in the key and replace them if necessary (▷ page 312).
or
- Use the mechanical key to unlock the doors (▷ page 310) and trunk (▷ page 311) as required. Lock the vehicle using the mechanical key (▷ page 311).

If the key is malfunctioning, contact an authorized Mercedes-Benz Center.

Checking the batteries

- ▶ Press button  or .

Battery check lamp **5** lights up briefly to indicate that the key batteries are in order.



If battery check lamp **5** does not light up briefly during check, then the key batteries are discharged.

Replace the batteries (▷ page 312).

You can obtain the required batteries at any authorized Mercedes-Benz Center.

Unlocking the trunk lid

You can unlock the trunk separately.

- ▶ Press and hold button  until trunk unlocks.



The trunk lid swings open upwards automatically. Always make sure that there is sufficient overhead clearance.



If the vehicle was previously centrally locked with the SmartKey, the trunk lid will lock automatically after closing it. The turn signals will flash three times to confirm locking.

If the trunk lid was previously separately locked (▷ page 94), the trunk lid will remain locked.

Opening the trunk lid

The handle is located in the rear license plate recess.

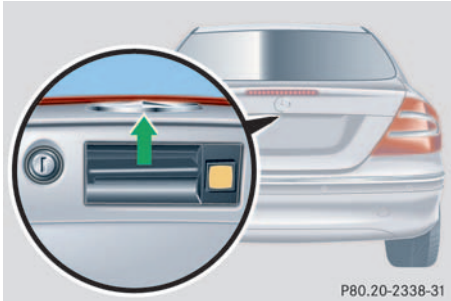

- ▶ Lift the trunk lid.

The trunk lid swings open upwards. Always make sure that there is sufficient overhead clearance.



The vehicle must be unlocked.

The trunk can also be opened from the inside in an emergency, see “Trunk lid emergency release” (▷ page 93).

Loss of SmartKey or mechanical key

If you lose a SmartKey or mechanical key, you should do the following:

- ▶ Have the SmartKey deactivated by an authorized Mercedes-Benz Center.
- ▶ Report the loss of the SmartKey or the mechanical key immediately to your car insurance company.
- ▶ If necessary, have the mechanical lock replaced.

Your authorized Mercedes-Benz Center will be glad to supply you with a replacement.

Locking and unlocking

SmartKey with KEYLESS-GO*

The KEYLESS-GO function is integrated into the SmartKey. On these vehicles, the validity of the SmartKey with KEYLESS-GO is checked every time you grasp a door handle.

If the SmartKey with KEYLESS-GO* is valid, your vehicle unlocks

- the doors
- the trunk lid
- the fuel filler flap

Warning!



When leaving the vehicle always remove the key from the starter switch, take the SmartKey with KEYLESS-GO (if so equipped) with you and lock the vehicle. Do not leave children unattended in the vehicle, or with access to an unlocked vehicle. Unsupervised use of vehicle equipment may cause an accident and/or serious personal injury.



To prevent possible malfunction, avoid exposing the SmartKey with KEYLESS-GO to high levels of electromagnetic radiation.

Important notes on using KEYLESS-GO*

- You can also use the SmartKey with KEYLESS-GO like a normal key (▷ page 84).
- You can combine KEYLESS-GO functions with normal key functions (e.g. unlocking with KEYLESS-GO and locking with the remote control).
- Always carry the SmartKey with KEYLESS-GO with you.
- Never store the SmartKey with KEYLESS-GO together with:
 - electronic items such as a cellular phone or another SmartKey with KEYLESS-GO
 - metallic objects such as coins or metal foilDoing so could impair the function of the KEYLESS-GO system.
- To lock or unlock the vehicle, the key must be located outside the vehicle within approximately 3 ft. (1 m) of a door or the trunk.

- In order to start the engine with the SmartKey with KEYLESS-GO:
 - the SmartKey with KEYLESS-GO must be located in the vehicle
 - all the doors must be closed
- If you have started the engine with the KEYLESS-GO start/stop button, you can only turn it off again with this button, even if you have put the key in the starter switch in the meantime.
- This does not apply if, after starting, the selector lever is still in position **P**. The SmartKey will then have priority over the KEYLESS-GO function and the vehicle's electrical system will operate according to the position of the key in the starter switch, even stopping the engine.
- If the SmartKey with KEYLESS-GO is positioned farther away from the vehicle (e.g. inside clothing or briefcase) and can no longer be recognized by the

system, the vehicle cannot be locked or the engine started via the KEYLESS-GO system.

- If the SmartKey with KEYLESS-GO is removed from the vehicle while the ignition is switched on (e.g. if passenger exits the vehicle with the key), the message *Key not recognized!* will appear in the multifunction display.

Find the key or change its present location immediately (e.g. place it on the front passenger seat or insert it in shirt pocket).

- Remember that the engine can be started by anyone with a SmartKey with KEYLESS-GO that is left inside the vehicle. If you leave the card behind when exiting and locking the vehicle, the message *Key recognized in vehicle!* will appear in the multifunction display.

Factory setting

Global unlocking

- ▶ Grasp the door handle.

The vehicle will lock again automatically within approximately 40 seconds if neither door nor trunk is opened.



The vehicle could inadvertently unlock if the SmartKey with KEYLESS-GO is within 3 ft. (1 m) of the vehicle and

- the door handle is splashed with water, or
- you attempt to clean the door handle.

Locking and unlocking

Global locking

- ▶ Press lock button at door handle (▷ page 53) or trunk lid (▷ page 91).



If you cannot lock or unlock the vehicle with the SmartKey with KEYLESS-GO, then either the batteries of the key are discharged or the key is malfunctioning.

- Check the batteries of the SmartKey with KEYLESS-GO (▷ page 86) and replace them if necessary (▷ page 312).
- Use the mechanical key to unlock the driver's door (▷ page 310) and trunk lid (▷ page 311) as required.

Lock the vehicle using the mechanical key (▷ page 311).

If your SmartKey with KEYLESS-GO is malfunctioning, contact your authorized Mercedes-Benz Center.

Unlocking the trunk lid

The handle is located in the rear license plate recess.

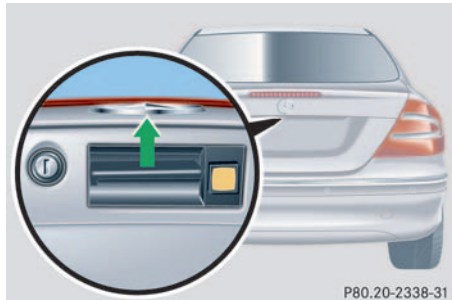

- ▶ Pull on the handle and lift up the trunk lid.

The vehicle unlocks the trunk lid only.

If the trunk lid does not open, it is still locked separately (▷ page 95).



The trunk lid swings open upwards automatically. Always make sure that there is sufficient overhead clearance.



If the vehicle was previously centrally locked with the SmartKey, the trunk lid will lock automatically after closing it. The turn signals will flash three times to confirm locking.

Vehicles with KEYLESS-GO:

To prevent a possible inadvertent lock-out, the trunk lid will open automatically if a SmartKey with KEYLESS-GO* is recognized in the area of the rear shelf or inside the trunk.

The trunk can also be opened from the inside in an emergency, see "Trunk lid emergency release" (▷ page 93).

Locking the vehicle

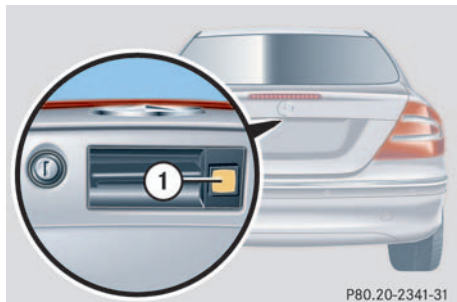

P80.20-2341-31

1 Trunk lock button

- ▶ Press the lock button at door (▷ page 53) or trunk.

Closing the side windows and sliding/pop-up roof

- ▶ Press and hold lock button at door (▷ page 53) until the side windows and the sliding/pop-up roof are closed.

Warning!



When closing the windows and the sliding/pop-up roof, be sure that there is no danger of anyone being harmed by the closing procedure.

If potential danger exists, proceed as follows:

- Release the lock button.
- Pull on the door handle and hold firmly. The side windows and the sliding/pop-up roof will open for as long as the door handle is held but the door not opened.

Loss of the SmartKey with KEYLESS-GO

If you lose your SmartKey with KEYLESS-GO, you should do the following:

- ▶ Have the SmartKey with KEYLESS-GO deactivated by an authorized Mercedes-Benz Center.
- ▶ Report the loss immediately to your car insurance company.
- ▶ Have the mechanical lock replaced if necessary.

Your authorized Mercedes-Benz Center will be glad to supply you with a replacement.

Locking and unlocking

Opening the doors from the inside

You can open a locked door from the inside. Open door only when conditions are safe to do so.

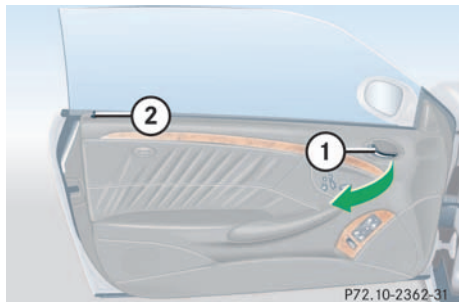

- 1 Inside door handle
- 2 Locking knob

► Pull on door handle 1.

If door was locked, locking knob 2 will move up.





If you open a door, the side windows on that side of the vehicle will lower slightly. The windows close again when you close the door.



If the vehicle has previously been locked from the outside with the remote control, opening a door from the inside will trigger the alarm.

To cancel the alarm, do one of the following:

- Press button  or  on the Smart Key.
- Insert the SmartKey in the starter switch.

Opening the trunk from the inside

You can open the trunk using the trunk lid release switch.



1 Remote trunk lid release switch with indicator lamp

► Push remote trunk lid release switch 1.

The trunk opens. The indicator lamp comes on. It remains lit until you close the trunk again.



The trunk lid swings open upwards automatically. Always make sure that there is sufficient overhead clearance.

If the trunk lid does not open, it is still locked separately (▷ page 95).

Trunk lid emergency release



The emergency release button is located in the trunk lid.

Illumination of the emergency release button:

- The button will blink for 30 minutes after opening the trunk.
- The button will blink for 60 minutes after closing the trunk.
- ▶ Briefly press the emergency release button.



The trunk unlocks and the trunk lid opens.



The emergency release button does not open the trunk lid if the vehicle battery is discharged or disconnected.



If the emergency release button is pressed and the vehicle was centrally locked, the exterior lamps will flash and the alarm will sound as the trunk lid opens.

To cancel the alarm, insert the key in the starter switch or press button  or  on the key.

Locking and unlocking

Closing the trunk lid



1 Handle

- ▶ Lower trunk lid by pulling firmly on handle 1.

Warning!



To prevent possible personal injury, always keep hands and fingers away from the trunk lid opening when closing the trunk. Be especially careful when small children are around.

Warning!



Only drive with the trunk closed as, among other dangers such as visibility blockage, exhaust fumes may enter the vehicle interior.



To prevent an inadvertent lockout, do not place the key in the trunk.

Vehicles with KEYLESS-GO:

To prevent a possible inadvertent lockout, the trunk lid will open automatically if a SmartKey with KEYLESS-GO* is recognized in the area of the rear shelf or inside the trunk.

Separately locking the trunk

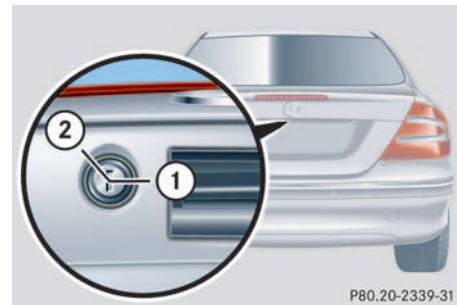

1 Locked

2 Unlocked

- ▶ Close the trunk lid (▷ page 94)
- ▶ Pull the mechanical key out of the SmartKey (▷ page 310).
- ▶ Insert the mechanical key into the trunk lid lock.
- ▶ Turn the key completely to the right to position 1.

The trunk remains locked even when the vehicle is centrally unlocked.



You can only cancel the separate trunk locking mode by means of the mechanical key.

Separately unlocking the trunk

- ▶ Turn the key completely to the left to position **2**.

You can now open the trunk.

Automatic central locking

The doors and the trunk automatically lock when the ignition is switched on and the wheels are turning at vehicle speeds of approximately 9 mph (15 km/h) or more.

You can open a locked door from the inside. Open door only when conditions are safe to do so.



The doors unlock automatically after an accident if the force of the impact exceeds a preset threshold.

The vehicle automatically locks when the ignition is switched on and the wheels are turning at vehicle speeds of approximately 9 mph (15 km/h) or more. You could therefore lock yourself out when the vehicle

- is pushed
- is on a test stand

You can deactivate the automatic locking using the control system (▶ page 133).

Locking and unlocking from the inside

You can lock or unlock the doors and the trunk from inside using the central locking switch. This can be useful, for example, if you want to lock the vehicle before starting to drive.

The fuel filler flap cannot be locked or unlocked with the central locking switch.

Warning!



When leaving the vehicle, always remove the key from the starter switch, take the Smart-Key with KEYLESS-GO* (if so equipped) with you and lock the vehicle. Do not leave children unattended in the vehicle, or with access to an unlocked vehicle. Unsupervised use of vehicle equipment may cause an accident and/or serious personal injury.

Locking and unlocking

The switch is located in the center console.

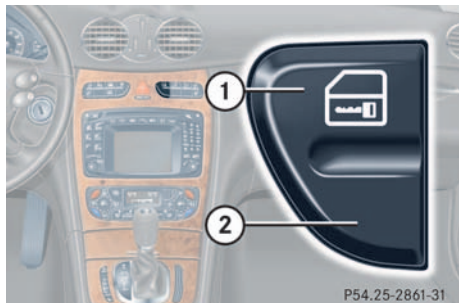

Central locking switch

- 1 Locking
- 2 Unlocking

Locking

- ▶ Press upper half **1** of the central locking switch.

If both doors are closed, the vehicle locks.

Unlocking

- ▶ Press lower half **2** of the central locking switch.

The vehicle unlocks.



You can open a locked door from the inside. Open door only when conditions are safe to do so.

If the vehicle was previously centrally locked with the SmartKey or the SmartKey with KEYLESS-GO* (if so equipped), it will not unlock using the central locking switch.

If the vehicle was previously locked with the central locking switch

- while in the global remote control mode, the complete vehicle is unlocked when a door is opened from the inside.
- while in the selective remote control mode, only the door opened from inside is unlocked.

Seats

Information on seat adjustment can be found in the “Getting started” section (▷ page 34).

Easy-entry/exit feature

With the easy-entry/exit feature activated, the steering wheel tilts upwards and the driver’s seat moves to the rear.

This allows easier entry into and exit from the vehicle when the driver’s door is opened. However, the engine must be turned off.

When the SmartKey is inserted in the starter switch or you have pressed the KEY-LESS-GO* start/stop button once and the driver’s door is closed, the steering wheel and the driver’s seat return to their last set positions.

Warning!



You must ensure that no one can become trapped or injured by the moving steering wheel and driver’s seat when the easy-entry/exit feature is activated, the driver’s door is being opened, and the engine is turned off or the SmartKey removed from the starter switch. Do not leave children unattended in the vehicle, or with access to an unlocked vehicle. Unsupervised use of vehicle equipment may cause an accident and/or serious personal injury.

You can activate the following functions:

- Steering column:
 - Only the steering column is adjusted.
- Steering column and seat:
 - Both the steering column and the seat are adjusted.

The easy-entry/exit feature can be switched on or off in the Convenience submenu of the control system (▷ page 133).

Head restraints

Information on head restraint adjustment can be found in the “Getting started” section (▷ page 36).

Warning!



For your protection, drive only with properly positioned head restraints.

Adjust head restraint to support the back of the head approximately at ear level.

Do not drive the vehicle without the seat head restraints. Head restraints are intended to help reduce injuries during an accident.



Tilt the seat backrest to the rear for easier removal and installation of the head restraints.

Seats

Front seat head restraints, power seat

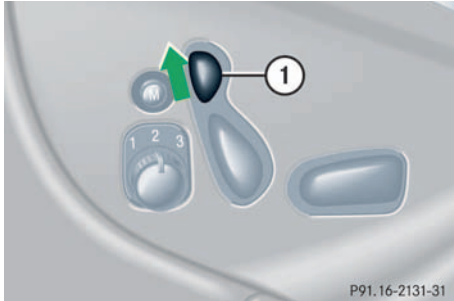

Removing front head restraints

- ▶ Press switch **1** upwards and hold until the head restraint is fully extended.
- ▶ Pull out head restraint.

Installing front head restraints:

- ▶ Press switch **1** upwards and hold for about five seconds.
- ▶ Push the head restraint down until it engages.
- ▶ Adjust head restraint to desired position.

Rear seat head restraints

Warning!



For safety reasons, always drive with the rear head restraints in the upright position when the rear seats are occupied.

Keep the area around head restraints clear of articles (e.g. clothing) to not obstruct the folding operation of the head restraints.

Folding rear head restraints back



- ▶ Make sure that the engine is running.
 - ▶ Press switch **1**.
- The rear head restraints will fold backward.

Folding rear head restraints back

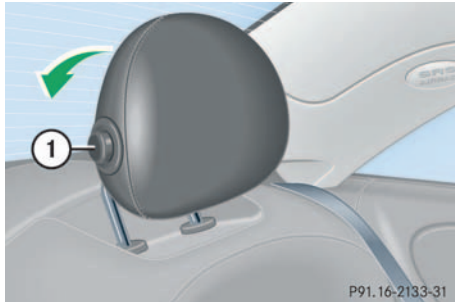

- ▶ Push release button 1.
The rear head restraints will fold backward.

Placing rear head restraints upright

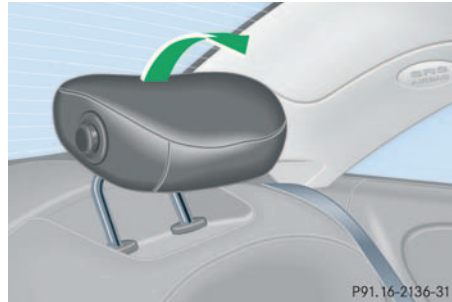

- ▶ Pull the rear head restraint forward until it locks into position.

Head restraint tilt

Two different head restraint angle positions are available.

- ▶ Press the release button and tilt the head restraint to the desired position.

Removing rear head restraints

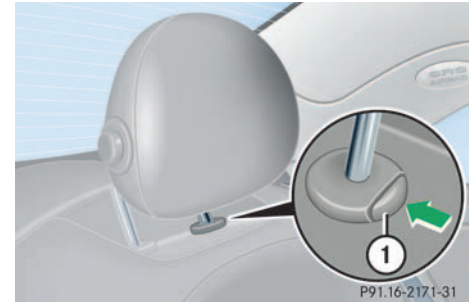

- ▶ Pull head restraint to its highest position.
- ▶ Push button 1 and pull out head restraint.

Installing rear head restraints

- ▶ Insert head restraint and push it down until it engages.
- ▶ Push button 1 and adjust head restraint to desired position.

Multicontour seat*

Some models may be equipped with multicontour seats. This seat has a movable seat cushion and inflatable air cushions built into the seat backrest to provide additional lumbar and side support.

The seat cushion movement, backrest cushion height and curvature can be continuously varied with regulators on the right side of the seat after turning the SmartKey in the starter switch to position **2** or pressing the KEYLESS-GO* start/stop button twice.

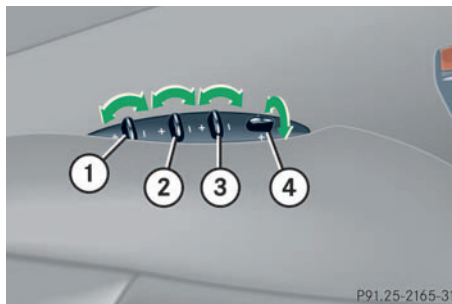

- 1 Seat cushion depth
- 2 Backrest bottom
- 3 Backrest center
- 4 Side bolster adjustment

Adjusting the multicontour seat in the order listed above is recommended.

- ▶ Make sure that the ignition is switched on.

All lamps in the instrument cluster light up.

The seat cushion movement, backrest cushion height and curvature can be adjusted with regulators **1**, **2** and **3**.

The side bolsters of the seat backrest can be adjusted with rocker switch **4**:

- ▶ Press to the left.
Side support will be increased.
- ▶ Press to the right.
Side support will be decreased.



When the engine is turned off, the last cushion setting is retained in memory, and the cushion is automatically adjusted to this setting when the engine is restarted.

Heated seats*

The switch is located in the center console.



1 Normal heating

2 Rapid heating

- ▶ Make sure that the ignition is switched on.

All the lamps in the instrument cluster light up.

Switching on seat heating

- ▶ Press upper switch position **1**.

A red indicator lamp on the switch lights up.

Switching on rapid seat heating

- ▶ Press lower switch position **2**.

Both red indicator lamps on the switch light up.



If one or both of the lamps on the seat heater switch are blinking, there is insufficient voltage available since too many electrical consumers are turned on. The seat heater switches off automatically.

The seat heater will switch back on again automatically as soon as sufficient voltage is available.



The system switches over to normal heating mode after approximately ten minutes. Only one indicator lamp remains lit.

Switching off seat heating

- ▶ If one indicator lamp is on, press upper switch position **1**.
- ▶ If both indicator lamps are on, press lower switch position **2**.



The seat heater will be automatically switched off after approximately 20 minutes.

Memory function

Memory function



Prior to operating the vehicle, the driver should check and adjust the seat height, seat position fore and aft, and seat backrest angle if necessary, to ensure adequate control, reach and comfort. The head restraint should also be adjusted for proper height. Also see air-bag section (▷ page 57) for proper seat positioning.

In addition, adjust the steering wheel to ensure adequate control, reach, operation and comfort. Both the inside and outside rear view mirrors should be adjusted for adequate rear vision.

Fasten seat belts. Infants and small children should be seated in a properly secured restraint system that complies with U.S. Federal Motor Vehicle Safety Standards 213 and 225 and Canadian Motor Vehicle Safety Standards 213 and 210.2.

The memory button and stored position switch are located on the door.

You can store up to three different settings per SmartKey or SmartKey with KEY-LESS-GO*.

The following settings are saved for each stored position:

- Driver's seat, backrest and restraint position
- Settings for multicontour seat*
- Steering wheel position
- Driver's side exterior rear view mirror position
- Passenger side exterior rear view mirror position

These key dependent memory settings can be deactivated if desired (▷ page 135).

Warning!



Do not activate the memory function while driving. Activating the memory function while driving could cause the driver to lose control of the vehicle.

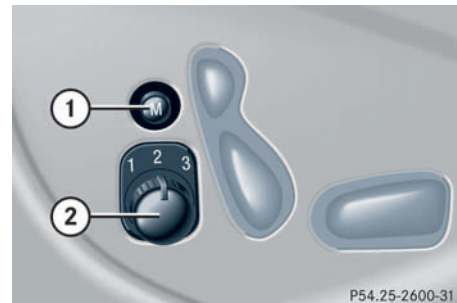

1 Memory button

2 Stored position button

- ▶ Be sure that the ignition is switched on or the relevant door is open and the SmartKey is inserted in the starter switch.

Storing positions into memory

- ▶ Adjust the seats, steering wheel and rear view mirrors to the desired position (▷ page 34).
- ▶ Turn button **2** to selected memory position.
- ▶ Press memory button **1**.
- ▶ Release memory button and push button **2** within three seconds.

All the settings are stored at the selected position.

Recalling positions from memory

- ▶ Turn button **2** to selected memory position.
- ▶ Press and hold button **2** until the seat, steering wheel and rear view mirrors have fully moved to the stored positions.



Releasing the button immediately stops movement to the stored positions.

Warning!



Do not operate the power seats using the memory button if the seat backrest is in an excessively reclined position. Doing so could cause damage to front or rear seats.

First move the seat backrest to an upright position.

Storing parking position

For easier parking you can adjust the passenger exterior rear view mirror so that you can see the right rear wheel as soon as you engage reverse gear **R**.



The mirror parking position feature (▷ page 135) must be activated and the passenger side exterior rear view mirror (▷ page 38) must be selected at the time in order for the system to recall the stored mirror position when reverse gear **R** is engaged.

The exterior rear view mirror returns to its previously stored driving position:

- 10 seconds after you put the gear selector lever out of position **R**
- immediately once you exceed a speed of approx. 6 mph (10 km/h)
- immediately when you press the button for driver's side mirror

Memory function

You can store a parking position for the passenger exterior rear view mirror for each SmartKey or SmartKey with KEYLESS-GO* using the memory switch.

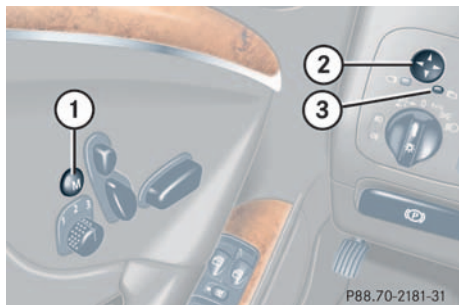

- 1 Memory button
- 2 Adjustment button
- 3 Passenger side exterior rear view mirror

- ▶ Stop the vehicle.
- ▶ Switch ignition on (if not already on).
- ▶ Press button **3** on the dashboard to the left of the steering wheel.

The passenger side exterior rear view mirror is selected.

- ▶ Adjust the exterior rear view mirror with button **2** so that you see the rear wheel and the curb.
- ▶ Press memory button “M” **1** on the door.
- ▶ Within three seconds, press bottom of adjustment button **2** above the exterior lamp switch.

The parking position is stored if the mirror does not move.



If the mirror does move, repeat the above steps. You can move the mirror again after the setting is stored.

For information about activating the parking position, see “Parking position” (▷ page 150)

Lighting

For notes on how to switch on the headlamps and use the turn signals, see the “Getting started” section (▷ page 46).

Exterior lamp switch

The exterior lamp switch is located on the dashboard to the left of the steering wheel.



P82.10-3024-31

- 0** Off
- AUTO** Automatic headlamp mode
-  Parking lamps (also side marker lamps, tail lamps, license plate lamps, instrument panel lamps)
Canada only: When engine is running, the low beam is also switched on.
-  Low beam plus parking lamps or high beam headlamps (combination switch pushed forward).
- P**  Standing lamps, right (turn left one stop)
- P**  Standing lamps, left (turn left two stops)

i

If you remove the key and open the driver's door while the parking lamps or low beam headlamps are switched on, then

- a warning sounds
-  appears in the multifunction display
- the message Turn off lamps! appears in the multifunction display

i

With the daytime running lamp mode activated and the engine running, the low beam headlamps cannot be switched off manually.

Lighting

Manual headlamp mode

The low beam headlamps and parking lamps can be switched on and off with the exterior lamp switch. For exterior lamp switch, see above.

Automatic headlamp mode

The parking lamps, low beam headlamps and license plate lamps switch on and off automatically depending on the brightness of the ambient light.

- ▶ Turn the exterior lamp switch to **AUTO**.



With the daytime running lamp mode activated, the low beam headlamps will not be switched off automatically.



Front fog lamps and rear fog lamp can not be switched on manually with exterior lamp switch in position **AUTO**. To activate the fog lamps, turn exterior lamp switch to position .

Warning!



In automatic headlamp mode, the headlamps will not be automatically switched on under foggy conditions. To minimize risk to you and to others, activate headlamps by turning exterior lamp switch to .

The driver is responsible for the operation of the vehicle's lights at all times. The automatic headlamp feature is only an aid to the driver. Switch on the vehicle lights manually when driving or when traffic conditions require you to do so.



If you drive in countries where vehicles drive on the other side of the road than the country where the vehicle is registered, you must have the headlamps modified for symmetrical low beams. Relevant information can be obtained at your authorized Mercedes-Benz Center.

Daytime running lamp mode

- ▶ Turn exterior lamp switch to position **0** or **AUTO**.

When the engine is running, the low beam headlamps are automatically switched on. In low ambient light conditions the parking lamps will also switch on.

Canada only

When you shift from a driving position to position **N** or **P**, the low beam switches off (with a three-minute delay).

For nighttime driving you should turn the exterior lamp switch to position  to permit activation of the high beam headlamps.

USA only

The high beam headlamps can also be activated when driving with the daytime running lamp mode activated and exterior lamp switch in position **0**.

To activate the daytime running lamp mode, see “Setting daytime running lamp mode (USA only)” (▷ page 129).



See notes on the exterior lamp switch (▷ page 105).

Locator lighting and night security illumination

Locator lighting and night security illumination are described in the control system section, see “Setting locator lighting” (▷ page 130) and see “Setting night security illumination (Exterior lamps delayed shut-off)” (▷ page 131).

Switching on front fog lamps

- ▶ Make sure that the low beam headlamps are switched on.
- ▶ Pull out exterior lamp switch to first stop.

The green indicator lamp  in the lamp switch lights up.



Fog lamps will operate with the parking lamps and/or the low beam headlamps on. Fog lamps should only be used in conjunction with low beam headlamps. Consult your State or Province Motor Vehicle Regulations regarding allowable lamp operation.

Switching on rear fog lamp

- ▶ Make sure that the low beam headlamps are switched on.
- ▶ Pull out exterior lamp switch to second stop.

The yellow indicator lamp  in the lamp switch lights up.

Combination switch

The combination switch is located on the left side of the steering column.

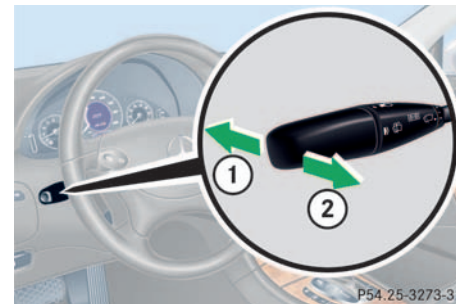

- 1 High beam
- 2 High beam flasher

Lighting

Switching on high beams

- ▶ Turn exterior lamp switch to position  or to **AUTO** (▷ page 105).
- ▶ Push the combination switch in direction **1**.

The high beam symbol is illuminated on the instrument cluster.

High beam flasher

- ▶ Pull the combination switch briefly in direction **2**.

Hazard warning flasher

The hazard warning flasher can be activated with the ignition switched on or off. It is activated automatically when an airbag is deployed.

The switch is located on the center console.



1 Hazard warning flasher switch

Switching on the hazard warning flasher

- ▶ Press the hazard warning flasher switch.

All turn signals will blink.



With the hazard warning flasher activated and the combination switch set for either left or right turn, only the respective left or right turn signals will operate when the key in the starter switch is in position **1** or **2**.

Switching off the hazard warning flasher

- ▶ Press hazard warning flasher switch again.



If the hazard warning flasher has been activated automatically, press the hazard warning flasher switch twice.

Interior lighting

The controls are located in the overhead control panel.



- 1 Rear interior lights
- 2 Right front reading lamp
- 3 Rocker switch: Automatic control off
- 4 Rocker switch: Automatic control on
- 5 Rocker switch: Front interior lights on
- 6 Left front reading lamp

Automatic control

Activating

- ▶ Press the rocker switch to the center position **4**.

Interior lamps are switched on in darkness, when

- the vehicle is unlocked
- a door is opened

The interior lamps are switched off after a set time¹ (▷ page 132).



If the door remains open, the interior lamps switch off automatically after approximately five minutes.

Deactivating

- ▶ Press the rocker switch to the right position **3**.

The interior lighting remains switched off in darkness, even when you

- unlock the vehicle
- open a door

¹ Only after the key has been removed from the starter switch is the interior lighting switched on for a set time.

Lighting

Manual control

Switching lamps on

- ▶ Press the rocker switch to the left position **5**.

The front interior lighting switches on.

Switching lamps off

- ▶ Press the rocker switch to the center position **4**.

The interior lighting switches off. The automatic control function is switched on.

Switching rear interior lights on

- ▶ Press switch **1**.

The rear compartment lighting is switched on.

Switching rear interior lights off

- ▶ Press switch **1**.

The rear compartment lighting is switched off.

Front reading lamps

Switching on

- ▶ Press switch **2** or **6**.

The corresponding reading lamp is switched on.

Switching off

- ▶ Press switch **2** or **6**.

The corresponding reading lamp is switched on.

Door entry lamps

The appropriate door entry lamp switches on if a door is opened in darkness and if the interior lighting is switched to automatic function.

The entry lamp switches off automatically when the door is closed.



If you turn the key in the starter switch to position **0** and switch off the exterior headlamps, the door entry lamps will remain lit for approximately five minutes.

Instrument cluster

A full view illustration of the instrument cluster can be found in the “At a glance” section of this manual (▷ page 22).

The instrument cluster is activated when you

- open a door
- turn on the ignition
- press the reset knob, see below
- switch on the exterior lamps

You can change the instrument cluster settings in the Instrument cluster submenu of the control system (▷ Seite 126).

Instrument cluster illumination



1 Reset knob

Use the reset knob to adjust the illumination brightness for the instrument cluster.



The instrument cluster illumination is dimmed or brightened automatically to suit ambient light conditions.

The instrument cluster illumination will also be adjusted automatically when you switch on the vehicle's exterior lamps.

To brighten illumination

- ▶ Turn reset knob **1** in the instrument cluster clockwise.

The instrument cluster illumination will brighten.

To dim illumination

- ▶ Turn reset knob **1** in the instrument cluster counterclockwise.

The instrument cluster illumination will dim.

Coolant temperature display

Warning!



- Driving when your engine is badly overheated can cause some fluids which may have leaked into the engine compartment to catch fire. You could be seriously burned.
- Steam from an overheated engine can cause serious burns and can occur just by opening the engine hood. Stay away from the engine if you see or hear steam coming from it.

Turn off the engine, get out of the vehicle and do not stand near the vehicle until it cools down.

During severe operating conditions and stop-and-go city traffic, the coolant temperature may rise close to 120°C.



The engine should not be operated with the coolant temperature above 120°C. Doing so may cause serious engine damage which is not covered by the Mercedes-Benz Limited Warranty.



Excessive coolant temperatures trigger a warning in the multifunction display.

Trip odometer

Make sure you are viewing the trip odometer display (▷ page 114).

- ▶ Press the button  or  on the multifunction steering wheel repeatedly until the trip odometer appears if it is not displayed.
- ▶ Press and hold reset knob **1** on the instrument cluster (▷ page 111) until the trip odometer is reset.

Tachometer

The red marking on the tachometer denotes excessive engine speed.



Avoid driving at excessive engine speeds, as it may result in serious engine damage that is not covered by the Mercedes-Benz Limited Warranty.

To help protect the engine, the fuel supply is interrupted if the engine is operated within the red marking.

Outside temperature indicator

Warning!



The outside temperature indicator is not designed to serve as an ice-warning device and is therefore unsuitable for that purpose.

Indicated temperatures just above the freezing point do not guarantee that the road surface is free of ice. The road may still be icy, especially in wooded areas or on bridges.

The temperature sensor is located in the front bumper area. Due to its location, the sensor can be affected by road or engine heat during idling or slow driving. This means that the accuracy of the displayed temperature can only be verified by comparison to a thermometer placed next to the sensor, not by comparison to external displays (e.g. bank signs etc.).

When moving the vehicle into colder ambient temperatures (e.g. when leaving your garage), you will notice a delay before the lower temperature is displayed.

A delay also occurs when ambient temperatures rise. This prevents inaccurate temperature indications caused by heat radiated from the engine during idling or slow driving.

Control system

Control system

The control system is activated as soon as the key in the starter switch is turned to position 1. The control system enables you to

- call up information about your vehicle
- change vehicle settings

For example, you can use the control system to find out when your vehicle is next due for service, to set the language for messages in the instrument cluster display, and much more.



The displays for the audio systems (radio, CD player, cassette player) will appear in English, regardless of the language selected.

Warning!



A driver's attention to the road and traffic must always be his /her primary focus when driving.

For your safety and the safety of others, selecting features through the multifunction steering wheel should only be done by the driver when traffic and road conditions permit it to be done safely.

Bear in mind that at a speed of just 30 mph (approximately 50 km/h), your vehicle is covering a distance of 44 feet (approximately 13.5 m) every second.

The control system relays information to the multifunction display.

Multifunction display



- 1 Outside temperature
- 2 Trip odometer
- 3 Automatic transmission program mode
- 4 Main odometer
- 5 Current gear selector lever position

Multifunction steering wheel

The displays in the multifunction display and the settings in the control system are controlled by the buttons on the multifunction steering wheel (▷ page 24).

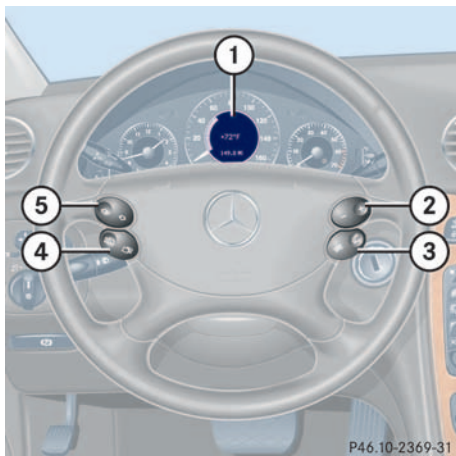

1	Multifunction display in the speedometer Operating the control system
2	Selecting the submenu or setting the volume down / to decrease up / to increase
3	Telephone* to take a call to end a call
4	Menu systems for next menu for previous menu
5	Moving within a menu for next display for previous display

Pressing any of the buttons on the multifunction steering wheel will alter what is shown in the multifunction display.

The information available in the multifunction display is arranged in menus, each containing a number of functions or sub-menus.

The individual functions are then found within the relevant menu (radio or CD operations under *Audio*, for example). These functions serve to call up relevant information or to customize the settings for your vehicle.

It is helpful to think of the menus, and the functions within each menu, as being arranged in a circular pattern.

- If you press button or repeatedly, you will pass through each menu one after the other.
- If you press button or repeatedly, you will pass through each function display, one after the other, in the current menu.

Control system

In the *Settings* menu, instead of functions you will find a number of submenus for calling up and changing settings. For instructions on using these submenus, see “Settings menu” (▷ page 123).

The number of menus available in the system depends on which optional equipment is installed in your vehicle.

The menus are described on the following pages.

Menus

This is what you will see when you scroll through the menus.

The table on the next page provides an overview of the individual menus.

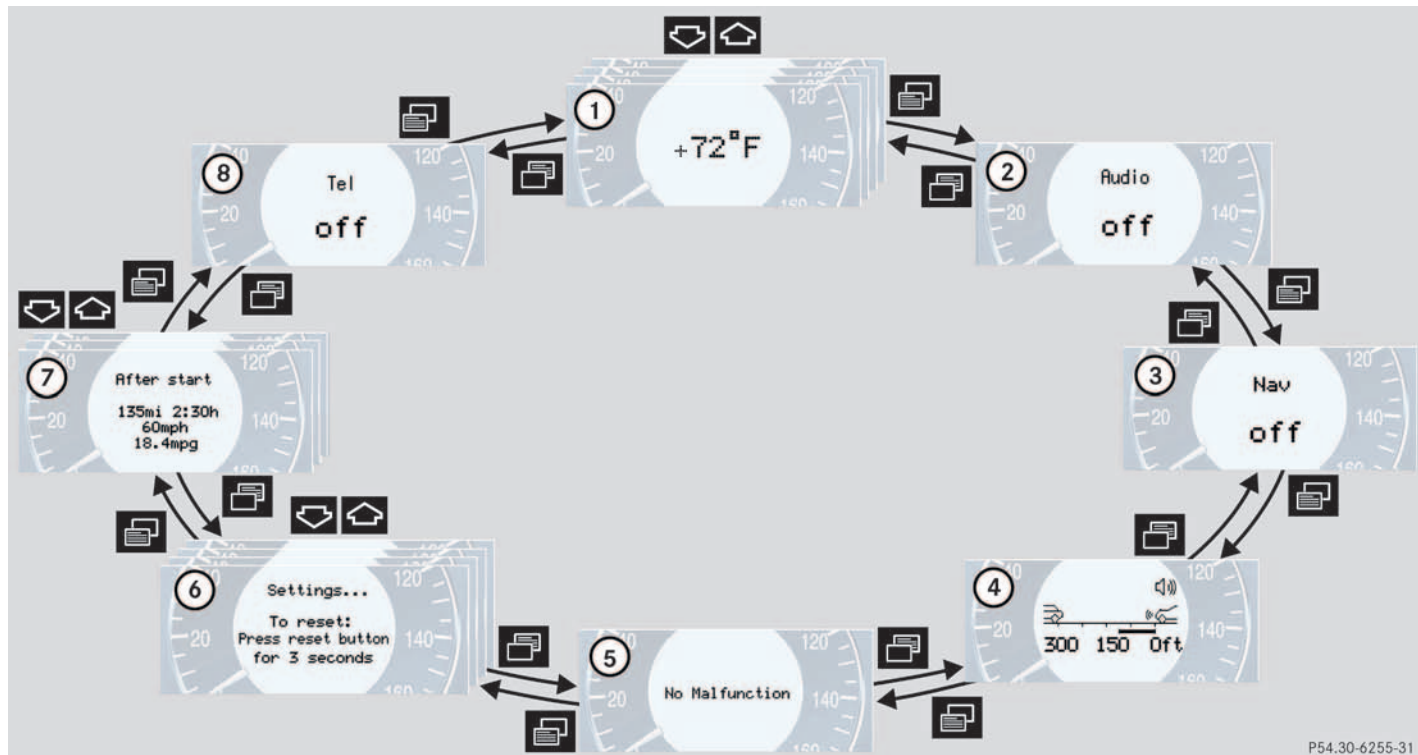

P54.30-6255-31

Control system

Menus, submenus and functions



	Menu 1	Menu 2	Menu 3	Menu 4	Menu 5	Menu 6	Menu 7	Menu 8
	Standard display	AUDIO	NAVI*	Distronic*	Malfunction memory	Settings	Trip computer	Telephone
Commands/submenus	Digital speedometer	Select radio station	Activate route guidance	Call up settings	Call up malfunction messages	Reset to factory settings	Fuel consumption statistics after start	Load phone book
	Call up FSS	Operate CD player*				Instrument cluster submenu	Fuel consumption statistics since the last reset	Search for name in phone book
	Check engine oil level	Operate cassette player				Time submenu	Call up range	
						Lighting submenu		
						Vehicle submenu		
						Convenience submenu		



The headings used in the menu table are designed to facilitate navigation within the system and are not necessarily identical to those shown in the control system displays.

The first function displayed in each menu will automatically show you which part of the system you are in.



Standard display menu

You can select the functions in the standard display menu with button  or .

The following functions are available:

Function	Page
Call up digital speedometer	see below
Call up FSS	267
Check engine oil level	254

Display digital speedometer

- ▶ Press the  or  button repeatedly until you see the digital speedometer appear in the display.

The current vehicle speed is shown in the multifunction display.

AUDIO menu

The functions in the **Audio** menu operate the audio equipment which you currently have turned on.



If no audio equipment is currently turned on, the message **Audio off** is shown in the display.

The following functions are available:

Function	Page
Select radio station	120
Operate CD player*	120
Operate cassette player	121

Control system

Select radio station

- ▶ Turn on the radio (▷ page 168). Vehicles with COMAND*: Refer to separate operating instructions.
- ▶ Press button  or  repeatedly until you see the currently tuned station in the display.

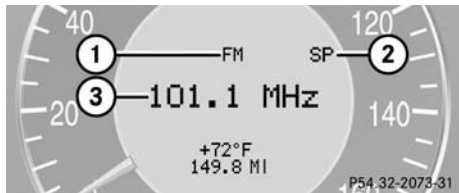

1 Waveband

2 Setting for station selection using memory

3 Station frequency

- ▶ Press button  or  repeatedly until the desired station is found.

The type of search depends on the setting for the station tuning (▷ page 132):



- The next stored station is selected (SP)
- Station search



You can only store new stations using the designated feature on the radio (▷ page 173). Vehicles with COMAND*: Refer to separate operating instructions.

You can also operate the radio in the usual manner.

Operate the CD player*

- ▶ Turn on the radio and select the CD player (▷ page 178). Vehicles with COMAND*: Refer to separate operating instructions.
- ▶ Press button  or  repeatedly until the settings for the CD currently being played are shown in the display.

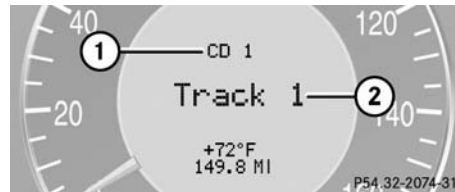

1 Current CD (for CD changer*)



2 Current track

- ▶ Press button  or  repeatedly until the desired track is selected.





To select a CD from the magazine, press a number on the audio system or the COMAND* system key pad located in the center dashboard.

Operate the Cassette player*

- ▶ Turn on the radio and select the cassette player (▷ page 174). Vehicles with COMAND*: Refer to separate operating instructions.
- ▶ Press button  or  repeatedly until the settings for the cassette currently being played are shown in the display.



1 Current side



- ▶ Press button  to fast forward to the next track.
- ▶ Press button  to rewind the cassette to the beginning of the current track.



To select the reverse side of the tape, press button below track number on the audio system display, or enter request on the COMAND* system located in the center dashboard.

NAV menu

The Nav menu contains the functions needed to operate your navigation system.



- ▶ Press button  or  repeatedly until you see the message Nav in the display.
 - If the navigation system is switched off, the message Nav off is shown in the display.
 - If the navigation system is on, the message Nav active is shown in the display.

Please refer to the COMAND* manual for instructions on how to activate the route guidance system*.

Distronic* menu

Use the Distronic menu to display the current settings for your Distronic system. What information is shown in the display depends on whether the Distronic system is active or inactive.

Please refer to the “Driving systems” section of this manual (▷ page 196) for instructions on how to activate Distronic.

- ▶ Press button  or  repeatedly until you see one of the following two pictures in the display.

Control system

Distronic deactivated

When DISTRONIC is deactivated you will see the standard display in the display.

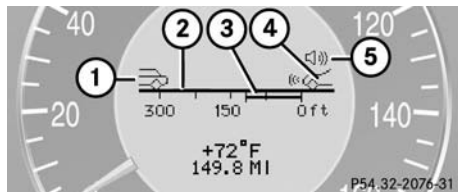

- 1 Vehicle ahead, if detected
- 2 Actual distance to vehicle ahead
- 3 Should-be distance to vehicle ahead
- 4 Your vehicle
- 5 Symbol for activated distance warning function

Distronic activated

When DISTRONIC is activated, DISTRONIC and the set speed are seen in the display.

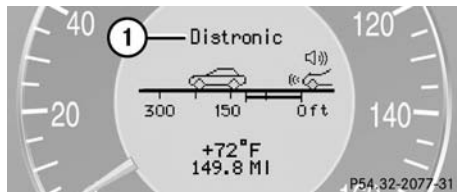

- 1 DISTRONIC activated



Malfunction memory menu

Use the malfunction memory menu to scan malfunction and warning messages that may be stored in the system. What information is shown in the display depends on whether malfunctions have actually occurred.

Warning!



Malfunction and warning messages are only indicated for certain systems and are intentionally not very detailed. The malfunction and warning messages are simply a reminder with respect to the operation of certain systems and do not replace the owner's and/or driver's responsibility to maintain the vehicle's operating safety by having all required maintenance and safety checks performed on the vehicle and by bringing the vehicle to an authorized Mercedes-Benz Center to address the malfunction and warning messages (▷ page 283).

- ▶ Press button  or  repeatedly until you see the malfunction message memory in the display.

No malfunction messages

If no malfunctions have occurred, the message in the display is:



No Malfunction

Malfunctions have occurred

If malfunctions have occurred, you will see the number of malfunctions in the display:



1 Number of malfunctions

- ▶ Press button  or .

The stored messages will now be displayed in order. See the “Practical hints” section for malfunction and warning messages (> page 283).



Should any malfunctions occur while driving, the number of malfunctions will reappear in the display when the key in the starter switch is turned to position **0** or removed from the starter switch.



The message memory will be cleared when you turn the key in the starter switch to position **1** or **2**. You will then only see Priority 1 malfunctions (> page 283).

Settings menu

In the Settings menu there are two functions:

- The function Reset to factory settings?, with which you can reset all the settings to the original factory settings.
 - A collection of submenus with which you can make individual settings for your vehicle.
- ▶ Press button  or  repeatedly until the Settings menu is seen in the display.



Control system

Resetting all settings

You can reset all the functions of all submenus to the factory settings.

- ▶ Press the reset knob in the instrument cluster for approximately three seconds.

In the display you will see the request to press the reset knob again to confirm.

- ▶ Press the reset knob again.

The functions of all the submenus will reset to factory settings.



The settings you have changed will not be reset unless you confirm the action by pressing the reset knob a second time. After approximately five seconds, you will see the *Settings...* menu again.

Submenus in the Settings menu

- ▶ Press button or .

In the display you see the collection of the submenus.



- ▶ Press button .

The selection marker moves to the next submenu.

The submenus are arranged by hierarchy. Scroll down with the button, scroll up with the button.

Move within the submenus with the or button to the individual functions.

The settings themselves are made with button or .

Resetting the functions of a submenu

For each submenu you can reset all the functions to the factory settings.

- ▶ Move to a function in the submenu.
- ▶ Press the reset knob (▷ page 111) in the instrument cluster for approximately three seconds.

In the display you will see the request to press the reset knob again to confirm.

- ▶ Press the reset knob again.

All functions of the submenu will reset to factory settings.

The table below shows what settings can be changed within the various menus. Detailed instructions on making individual settings can be found on the following pages.

INSTRUMENT CLUSTER	TIME	LIGHTING	VEHICLE	CONVENIENCE
Select temperature display mode	Set time (hours)	Set daytime running lamp mode (USA only)	Set station selection mode (radio)	Activate easy-entry/exit feature
Select speedometer display mode	Set time (minutes)	Set locator lighting	Set automatic locking	Set key dependency
Select language		Exterior lamps delayed shut-off		Set parking position for exterior rear view mirror
Select display (speed display or outside temperature) for status display		Interior lighting delayed shut-off		
Select display (speed display or outside temperature) for standard display				



Control system

Instrument cluster submenu

Access the Instr. cluster submenu via the Settings menu. Use the Instr. cluster submenu to change the instrument cluster display settings. The following functions are available:

Function	Page
Select temperature display mode	126
Select speedometer display mode	126
Select language	127
Select display (speed display or outside temperature) for status display	127
Select display (speed display or outside temperature) for standard display	128

Selecting temperature display mode

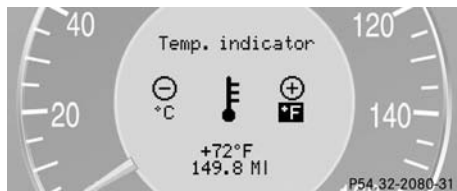

- ▶ Move the selection marker with the **+** or **-** button to the Instr. cluster submenu.
- ▶ Press button  or  repeatedly until you see this message in the display: Temp. indicator.

The selection marker is on the current setting.



- ▶ Press **+** or **-** to set the temperature unit to degrees Celsius (°C) or degrees Fahrenheit (°F).

Selecting speedometer display mode

- ▶ Move the selection marker with the **+** or **-** button to the Instr. cluster submenu.
- ▶ Press button  or  repeatedly until you see this message in the display: Display unit.

The selection marker is on the current setting.



- ▶ Press **+** or **-** to set speedometer unit to km or miles.

Selecting language

► Move the selection marker with the **+** or **-** button to the Instr. cluster submenu.

► Press button **↶** or **↷** repeatedly until you see this message in the display: Language.

The selection marker is on the current setting.



► Press **+** or **-** to select the language to be used for the multifunction display messages.

Available languages:

- German
- English
- Italian
- French
- Spanish

Selecting display (speed display or outside temperature) for status indicator

► Move the selection marker with the **+** or **-** button to the Instr. cluster submenu.

► Press button **↶** or **↷** repeatedly until you see this message in the display: Status line display.

The selection marker is on the current setting.

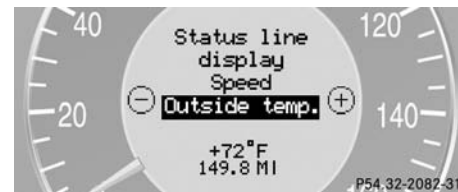

► Press **+** or **-** to select the statusline to degrees Fahrenheit (°F) or miles



You will see the status indicator when you have called up a different display from the standard display.

Control system

Selecting display (speed display or outside temperature) for standard display

- ▶ Move the selection marker with the **+** or **-** button to the Instr. cluster submenu.
- ▶ Press button **↕** or **↴** repeatedly until you see this message in the display: *Basic display*.

The selection marker is on the current setting.

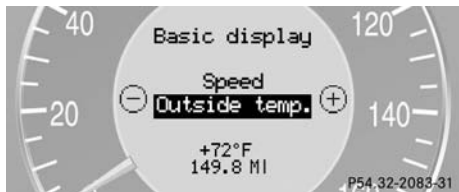

- ▶ Press **+** or **-** to select the display permanently shown in the multi-function display.

Time submenu

Access the Time submenu via the Settings menu. Use the Time submenu to change the time display settings. The following functions are available:

Function	Page
Set time (hours)	128
Set time (minutes)	129

Set time (hours)

- ▶ Move the selection marker with the **+** or **-** button to the Time submenu.
- ▶ Press button **↕** or **↴** repeatedly until you see this message in the display: *Clock, hours*.

The selection marker is on the hour setting.



- ▶ Press **+** or **-** to set the hour.
- ▶ Press the reset knob in the instrument cluster to confirm.

The hour is set and stored.

Set time (minutes)

- ▶ Move the selection marker with the **+** or **-** button to the Time submenu.
- ▶ Press button **↶** or **↷** repeatedly until you see this message in the display: Clock, minutes.

The selection marker is on the minute setting.



- ▶ Press **+** or **-** to set the minutes.
- ▶ Press the reset knob in the instrument cluster to confirm.

The minutes are set and stored.

Lighting submenu

Access the Lighting submenu via the Settings menu. Use the Lighting submenu to change the lamp and lighting settings on your vehicle. The following functions are available:

Function	Page
Set daytime running lamp mode (USA only)	see below
Set locator lighting	130
Exterior lamps delayed switch-off	131
Interior lighting delayed switch-off	132

Setting daytime running lamp mode (USA only)

- ▶ Move the selection marker with the **+** or **-** button to the Lighting submenu.
- ▶ Press button **↶** or **↷** repeatedly until you see this message in the display: Lamp circuit headlamp.

The selection marker is on the current setting.



- ▶ Press **+** or **-** to select manual or daytime running lamp (constant) mode. This function is not available in countries where daytime running lamps are mandatory.

Control system

With daytime running lamp mode selected and the exterior lamp switch at position **0**, the following lamps will come on automatically when the engine is turned on:

- Parking lamps and low beam headlamps
- License plate lamps (in low ambient light conditions)



If you turn the exterior lamp switch to another position, the corresponding lamp(s) will switch on.

For safety reasons, resetting the Lighting submenu to factory settings (▷ page 124) will not reset the daytime running lamp mode.

In the display you will then see the message: Lighting - Cannot be completely reset to factory settings while driving.

Setting locator lighting

During darkness, the following lamps will come on when the exterior lamp switch is in position **AUTO**, the locator lighting feature is activated, and the vehicle is unlocked by remote control:

- Parking lamps
- Tail lamps
- License plate lamps
- Front fog lamps

To activate locator lighting:

- ▶ Make sure the function surround lighting is set to on (see below).
- ▶ Turn the exterior lamp switch to position **AUTO**.

The locator lighting switches off when the driver's door is opened. It switches off automatically after a period of approximately 40 seconds.

- ▶ Move the selection marker with the **+** or **-** button to the Lighting submenu.
- ▶ Press button or repeatedly until you see this message in the display: Function Surround lighting.

The selection marker is on the current setting.

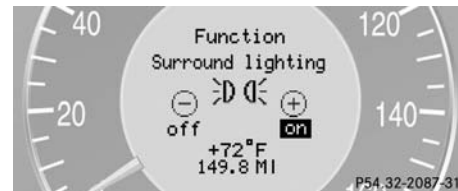

- ▶ Press **+** or **-** to select the desired setting.

The locator lighting will be switched on or off.

Setting night security illumination (Exterior lamps delayed shut-off)

Use the Headlamps delayed shut-off function to set whether and for how long you would like the exterior lamps to illuminate during darkness after all doors are closed. When the delayed shut-off feature is activated and the exterior lamp switch is in position **AUTO**, the following lamps will remain lit after you remove the key from the starter switch:

- Parking lamps
- Tail lamps
- License plate lamps
- Front fog lamps



You can reactivate this function within ten minutes by opening a door.

If you do not open a door after removing the key, the lamps will automatically switch off after 60 seconds.

To activate night security illumination:

- ▶ Select delayed shut-off period (see below).
- ▶ Turn the exterior lamp switch to position **AUTO**.

To select delayed shut-off period:

- ▶ Move the selection marker with the **+** or **-** button to the Lighting submenu.
- ▶ Press button or repeatedly until you see this message in the display: Headlamps delayed shut-off.

The selection marker is on the current setting.

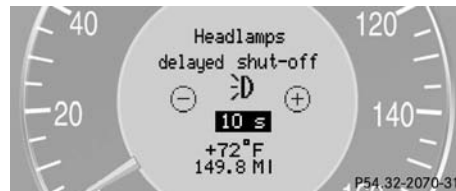

- ▶ Press **+** or **-** to select the desired lamp-on period.

You can select:

- 0 s, the delayed shut-off feature is deactivated
- 15 s, 30 s, 45 s or 60 s, the delayed shut-off feature is activated

You can temporarily deactivate the delayed shut-off feature:

- ▶ Before leaving the vehicle turn the key in the starter switch to position **0**.
- ▶ Then turn it to position **2** and back to **0**.

The delayed shut-off feature is deactivated. It will reactivate as soon as you reinsert the key in the starter switch.

For vehicles with KEYLESS-GO*:

- ▶ Press the KEYLESS-GO start/stop button on the gear selector lever (▷ page 33).

Control system

Interior lighting delayed shut-off

Use this function to set whether and for how long you would like the interior lighting to remain lit during darkness after the key is removed from the starter switch.

- ▶ Move the selection marker with the **+** or **-** button to the Lighting submenu.
- ▶ Press button **↶** or **↷** repeatedly until you see this message in the display: Interior lamp delayed shut-off.

The selection marker is on the current setting.



- ▶ Press **+** or **-** to select the desired lamp-on time period. You can select:
 - 0 s, the delayed shut-off feature is deactivated.
 - 5 s, 10 s, 15 s or 20 s, the delayed shut-off feature is activated.

Vehicle submenu

Access the Vehicle submenu via the Settings menu. Use the Vehicle submenu to make general vehicle settings. The following functions are available:

Function	Page
Set station selection mode (radio)	see below
Set automatic locking	see below

Setting station selection mode

Use the Audio Search function to select the manual or memory station selection mode for the radio (▷ page 120).

- ▶ Move the selection marker with the **+** or **-** button to the Vehicle submenu.
- ▶ Press button **↶** or **↷** repeatedly until you see this message in the display: Audio Search function.

The selection marker is on the current setting.



- ▶ Press **+** or **-** to select the desired station selection mode. You can select:
 - freq.
 - memory selects next stored station

Setting automatic locking

Use this function to activate or deactivate the automatic central locking. With the automatic central locking system activated, the vehicle is centrally locked at vehicle speeds of approximately 9 mph (15 km/h).

- ▶ Move the selection marker with the **+** or **-** button to the Vehicle submenu.
- ▶ Press button **↕** or **↓** repeatedly until you see this message in the display: Automatic door lock.

The selection marker is on the current setting.



- ▶ Press **+** or **-** to switch Automatic door lock on or off.

Convenience submenu

Access the Convenience submenu via the Settings menu. Use the Convenience submenu to change the settings for a number of convenience features. The following functions are available:

Function	Page
Activate easy-entry/exit feature	see below
Set key dependency	135
Set parking position for exterior rear view mirror	135

Activating easy-entry/exit feature

Use this function to activate and deactivate the easy-entry/exit feature. When the feature is activated, the steering wheel and driver's seat will move back to facilitate exiting when you

- remove the key from the starter switch
- open the driver's door

However, the engine must be turned off.

Warning!



You must make sure that no one can become trapped or injured by the moving steering wheel and the driver's seat when the easy-entry/exit feature is in operation and the driver's door is being opened or the key is removed from the starter switch. Do not leave children unattended in the vehicle, or with access to an unlocked vehicle. Unsupervised use of vehicle equipment may cause an accident and/or serious personal injury.

Do not leave children unattended in the vehicle, or with access to an unlocked vehicle. Children could open the driver's door and unintentionally activate the easy-entry/exit feature, which could result in an accident and/or serious personal injury.



After entering the vehicle, the steering wheel and seat will move into the position stored in memory when

- the driver's door is closed
- you put the key in the starter switch
- press the appropriate stored position button on the memory switch (▷ page 102).



To cancel seat/steering wheel movement, do one of the following:

- Press seat adjustment switch (▷ page 35)
- Move the steering column stalk (▷ page 37)
- Press the memory switch (▷ page 102)

- ▶ Move the selection marker with the **+** or **-** button to the Convenience submenu.
- ▶ Press button  or  repeatedly until you see this message in the display: Function Easy-entry feature.

The selection marker is on the current setting.

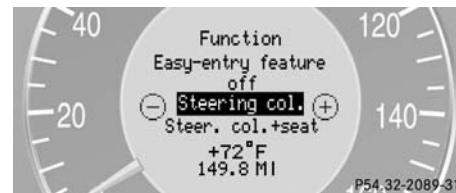

- ▶ Press **+** or **-** to change the easy-entry/exit setting.

The following settings are available for the easy-entry/exit feature:

off	The easy-entry/exit feature is deactivated.
Steering col.	Only the steering column is moved.
Steer. col. + seat	Both the steering column and the seat are moved.

Setting key dependency

Use this function to set whether the memory settings for the seats, the steering wheel and the mirrors should be stored separately for each key (▷ page 102).

- ▶ Move the selection marker with the **+** or **-** button to the Convenience submenu.
- ▶ Press button **↕** or **↓** repeatedly until you see this message in the display: Key-dependent.

The selection marker is on the current setting.



- ▶ Press **+** or **-** to set key dependency to on or off.

Setting parking position for exterior rear view mirror

Use the Mirror adjustment parking aid function to select whether the passenger-side exterior rear view mirror should be turned downward during parking maneuvers (when reverse gear is engaged).

For information about activating the parking position, see "Parking position" (▷ page 150).

The exterior rear view mirror will return to its previous position when you

- shift out of reverse (after 10 seconds)
 - exceed a speed of 6 mph (10 km/h), regardless of which gear is engaged
 - press the driver's side mirror button (immediately)
- ▶ Move the selection marker with the **+** or **-** button to the Convenience submenu.
 - ▶ Press button **↕** or **↓** repeatedly until you see this message in the display: Mirror adjustment parking aid.

The selection marker is on the current setting.



- ▶ Press **+** or **-** to switch function on or off.

Control system



The mirror parking position feature must be activated and the passenger side exterior rear view mirror (▷ page 38) must be selected at the time in order for the system to recall the stored mirror position when reverse gear **R** is engaged.

Trip computer menu

Use the trip computer menu to call up statistical data on your vehicle. The following information is available:

Function	Page
Fuel consumption statistics after start	see below
Fuel consumption statistics since last reset	137
Call up range (distance to empty)	137

Fuel consumption statistics after start

- ▶ Press button or repeatedly until you see the first function of the Trip computer menu.
- ▶ Press button or repeatedly until you see this message in the left display: After start.

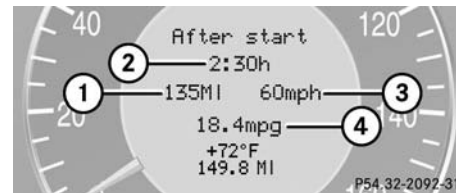

- 1 Distance driven since start
- 2 Time elapsed since start
- 3 Average speed since start
- 4 Average fuel consumption since start



All statistics stored since the last engine start will be reset approximately four hours after the key in the starter switch is turned to position **0** or removed from the starter switch.

Resetting will not occur if you turn the key back to position **1** or **2** within this time period.

Fuel consumption since last reset

- ▶ Press button or repeatedly until you see the first function of the Trip computer menu.
- ▶ Press button or repeatedly until you see this message in the display: *After reset.*

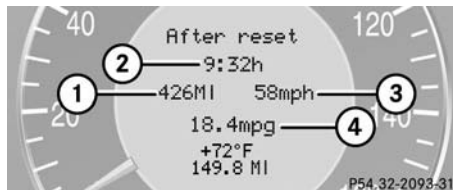

- 1 Distance driven since last reset
- 2 Time elapsed since last reset
- 3 Average speed since last reset
- 4 Average fuel consumption since last reset

Resetting fuel consumption statistics

- ▶ Press button or repeatedly until you see the first function of the Trip computer menu.
- ▶ Press button or repeatedly until you see the reading that you want to reset in the display.
- ▶ Press and hold the reset knob in the instrument cluster (▷ page 111) until the value is reset to 0.

Call up range (distance to empty)

- ▶ Press button or repeatedly until you see the first function of the Trip computer menu.
- ▶ Press button or repeatedly until you see this message in the display: *Range.*

In the display you will see the calculated range based on the current fuel tank level.

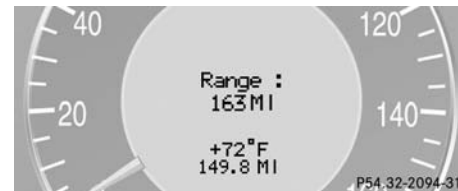

Control system

TEL menu*

Warning!





A driver's attention to the road must always be his/her primary focus when driving. For your safety and the safety of others, we recommend that you pull over to a safe location and stop before placing or taking a telephone call. If you choose to use the telephone while driving, please use the hands-free device and only use the telephone when weather, road, and traffic conditions permit.

Some jurisdictions prohibit the driver from using a cellular telephone while driving a vehicle.

Bear in mind that at a speed of just 30 mph (approximately 50 km/h), your vehicle is covering a distance of approximately 44 feet (approximately 13.5 m) every second.

Never operate radio transmitters equipped with a built-in or attached antenna (i.e. without being connected to an external antenna) from inside the vehicle while the engine is running. Doing so could lead to a malfunction of the vehicle's electronic system, possibly resulting in an accident and/or personal injury.

You can use the functions in the **Te1** menu to operate your telephone, provided it is connected to a hands-free system and switched on.

- ▶ Switch on the telephone and Audio or COMAND*.
- ▶ Press button  or  on the steering wheel repeatedly until you see the **Te1** menu in the display.

Which messages will appear in the display field depends on whether your telephone is switched on or off:

- If the telephone is off, the message in the multifunction display is: **Te1 off**.
- If the telephone is on:

The telephone will then search for a network. During this time the display is empty.

As soon as the telephone has found a network, **READY** is indicated in the display.



1 Signal strength

This standby message indicates that your telephone is ready for use and you can operate it using the control system.

Answering a call

When your telephone is ready to receive calls, you can answer a call at any time. In the display you will then see the message:



- ▶ Press button .

You have answered the call. In the display you see the length of the call.



If you do not wish to accept a call, press button .





Ending a call

- ▶ Press button .

You have ended the call. In the display you will again see the standby message.



Dialing a number from the phone book

If your telephone is ready to receive calls, you may select and dial a number from the phone book at any time.

- ▶ Press button  or  repeatedly until you see the Tel menu in the display.
- ▶ Press button  or .



The control system reads the phone book which is stored in the telephone. This may take up to 30 seconds. In the display you will see the message `Please wait`.

When the message `Please wait` disappears, the phone book has been loaded.

- ▶ Press button  or  repeatedly until the desired name appears in the display.

The stored names are displayed in increasing or decreasing alphabetical order.



If you press and hold  or  for longer than one second, the system scrolls rapidly through the list of names until you release the button again.

Cancel the quick search mode by pressing .

Control system

- ▶ Press button .

The system dials the selected phone number.

- If connection is successful, the name of the party you called and the duration of the call will appear in the display.



- If no connection is made, the control system stores the dialed number in the redial memory.



Redialing

The control system stores the most recently dialed phone numbers. This eliminates the need to search through your entire phone book.

- ▶ Press button  or  repeatedly until you see the Tel menu in the display.

- ▶ Press button .

In the display you see the first number in the redial memory.

- ▶ Press button  or  repeatedly until the desired name appears in the display.



If you do not want to use the telephone, press button .

- ▶ Press button .

The control system dials the selected phone number.

Automatic transmission

Information for driving with an automatic transmission is found in the “Getting started” section (▷ page 43).

Your transmission adapts its gear shifting process to your individual driving style by continually adjusting the shift points up or down. These shift point adjustments are performed based on current operating and driving conditions.

If the operating conditions change the automatic transmission reacts by adjusting its gear shift program.



During the brief warm-up the transmission upshifting is delayed. This allows the catalytic converter to heat up more quickly to operating temperatures.

The automatic transmission selects individual gears automatically, depending on

- the selector lever position **D** with gear ranges **4, 3, 2, 1** (▷ page 143)
- the selected shift program (**W/S**) (▷ page 145) or (**M/C/S**) (CLK 55 AMG)(▷ page 147)
- the position of the accelerator pedal (▷ page 146)
- the vehicle speed

The current selector lever position and shift program (**W/S**) or (**M/C/S**) (CLK 55 AMG) appear in the speedometer display (▷ page 114).

Warning!



It is dangerous to shift the selector lever out of **P** or **N** if the engine speed is higher than idle speed. If your foot is not firmly on the brake pedal, the vehicle could accelerate quickly forward or reverse. You could lose control of the vehicle and hit someone or something. Only shift into gear when the engine is idling normally and when your right foot is firmly on the brake pedal.

When the selector lever is in position **D**, you can influence transmission shifting by

- limiting the gear range
- changing gears yourself

Automatic transmission

One-touch gearshifting

Even with an automatic transmission you can change the gears yourself when the selector lever is in position **D**.

Downshifting

- ▶ Briefly press the selector lever to the left in the **D-** direction.

The transmission will shift from the current gear to the next lower gear. This action simultaneously limits the gear range of the transmission (▷ page 143).

Warning!



On slippery road surfaces, never downshift in order to obtain braking action. This could result in drive wheel slip and reduced vehicle control. Your vehicle's ABS will not prevent this type of loss of control.



To avoid overrevving the engine when the selector lever is moved in the **D-** direction, the transmission will not shift to a lower gear if the engine's max. speed would be exceeded.

Upshifting

- ▶ Briefly press the selector lever to the right in the **D+** direction.

The transmission will shift from the current gear to the next higher gear as permitted by the shift program. This action simultaneously extends the gear range of the transmission.

Canceling gear range limit

- ▶ Press and hold the selector lever in the **D+** direction until **D** reappears in the tachometer display field.

The transmission will shift from the current gear range directly to gear range **D**.

Shifting into optimal gear range

- ▶ Press and hold the gear selector lever in the **D-** direction.

The transmission will automatically select the gear range suited for optimal acceleration and deceleration. This will involve shifting down one or more gears.

Gear ranges

With the selector lever in position **D**, you can limit the transmission's gear range by pressing the lever to the left (**D-**), and reverse the gear range limit by pressing the lever to the right (**D+**).

The selected gear range will appear in the tachometer display field. If you press on the accelerator when the engine has reached its rpm limit, the transmission will upshift beyond any gear range limit selected.

Gear range	Effect
4	The transmission shifts through fourth gear only.
3	The transmission shifts through third gear only. With this selection you can use the braking effect of the engine.

Gear range	Effect
2	The transmission shifts through second gear only. Allows the use of engine's braking power when driving <ul style="list-style-type: none"> • on steep downgrades • in mountainous regions • under extreme operating conditions
1	The transmission operates only in first gear. For maximum use of engine's braking effect on very steep or lengthy downgrades.

Automatic transmission

Gear selector lever position

	Effect
P	Park position <p>Selector position when the vehicle is parked. Only place selector lever in position P when vehicle is stopped. The park position is not intended to serve as a brake when the vehicle is parked. Rather, the driver should always set the parking brake in addition to placing the selector lever in position P to secure the vehicle.</p> <p>The key can only be removed from the starter switch with the selector lever in position P. With the key removed the selector lever is locked in position P.</p>

	Effect
R	Reverse gear <p>Place selector lever in position R only when vehicle is stopped.</p>
N	Neutral <p>No power is transmitted from the engine to the drive axle. When the brakes are released, the vehicle can be moved freely (pushed or towed).</p> <p>To avoid damage to the transmission, never engage N while driving.</p> <p>If the ESP is deactivated or malfunctioning: Only move selector lever to N if the vehicle is in danger of skidding (e.g. on icy roads).</p>
D	Drive <p>The transmission shifts automatically. All five forward gears are available.</p>



Coasting the vehicle, or driving for any other reason with selector lever in **N** can result in transmission damage that is not covered by the Mercedes-Benz Limited Warranty.

Warning!



Getting out of your vehicle with the selector lever not fully engaged in position **P** is dangerous. Also, position **P** alone is not intended to or capable of preventing your vehicle from moving, possibly hitting people or objects.

Always set the parking brake in addition to shifting to position **P** (▷ page 45).

When parked on an incline, turn the front wheels towards the road curb.

Warning!



When leaving the vehicle, always remove the key from the starter switch, take the Smart-Key with KEYLESS-GO* (if so equipped) with you and lock the vehicle. Do not leave children unattended in the vehicle, or with access to an unlocked vehicle. Children could move the selector lever from position **P**, which could result in an accident and/or serious personal injury.

Program mode selector switch



1 Program mode selector switch

S Standard For regular driving

W Winter For winter driving



Never change the program mode when the selector lever is out of position **P**. It could result in a change of driving characteristics for which you may not be prepared.

- ▶ Press the program mode selector switch repeatedly until the letter of the desired shift program appears in the speedometer display field (▷ page 114).

Select **W** for winter driving:

- The vehicle starts out in second gear (both forward and reverse) for gentler starts. This does not apply if full throttle is applied or gear range **1** is selected.
- Traction and driving stability are improved on icy roads.
- Upshifts occur earlier even when you give more gas. The engine then operates at lower rpms and the wheels are less likely to spin.
- The power transmission ratio for selector lever position **R** changes depending on the program mode selected (**W** or **S**).

Automatic transmission

Accelerator position

Your driving style influences the transmission's shifting behavior:

Less throttle	Earlier upshifting
More throttle	Later upshifting

Kickdown

Use kickdown when you want maximum acceleration.

- ▶ Press the accelerator past the point of resistance.

The transmission shifts into a lower gear.

- ▶ Ease on the accelerator when you have reached the desired speed.

The transmission shifts up again.

Emergency operation (Limp Home Mode)

If vehicle acceleration worsens or the transmission no longer shifts, the transmission is most likely operating in limp home (emergency operation) mode. In this mode, only 2nd gear and reverse gear can be activated.

- ▶ Stop the vehicle.
- ▶ Move selector lever to **P**.
- ▶ Turn off the engine.
- ▶ Wait at least ten seconds before re-starting.
- ▶ Move selector lever to position **D** (for 2nd gear) or **R**.
- ▶ Have the transmission checked at an authorized Mercedes-Benz Center as soon as possible.

Steering wheel gearshift control (Speedshift) and manual shift program CLK 55 AMG

The CLK 55 AMG can be driven in both the automatic and manual shift program modes. In the manual shift program mode, you can change the gears yourself on the steering wheel or by using the selector lever.



- 1 Shift button
- 2 Left button: downshift
- 3 Right button: upshift

To do so, you must first select the manual shift program **M** on the program mode selector switch.



1 Program mode selector switch

- S** SPORT For regular driving
- C** COMFORT For comfortable driving
- M** MANUAL For manual gear shifting

The selected shift program (S/C/M) is indicated in the speedometer display field (▷ page 114).



Never change the program mode when the selector lever is out of position **P**. It could result in a change of driving characteristics for which you may not be prepared.

Activating steering wheel gearshift control

- ▶ Press the program mode selector switch repeatedly until the **M** for manual shift program appears in the speedometer display field.
Automatic gear shifting is deactivated.

Upshifting

- ▶ Press button **3** located on the right side of the steering wheel.
- or
- ▶ Briefly press the selector lever to the right in the **D+** direction.

The transmission shifts to the next higher gear.

Warm up the engine gently. Do not place full load on the engine until the operating temperature has been reached. Shift into reverse gear only when the vehicle is stopped.



When driving off on slippery road surfaces, avoid spinning a drive wheel for longer periods. This may cause damage to the drivetrain.

Automatic transmission

Downshifting

- ▶ Press button **2** located on the left side of the steering wheel.
or
- ▶ Briefly press the selector lever to the left in the **D-** direction.

The transmission shifts to the next lower gear.

Warm up the engine gently. Do not place full load on the engine until the operating temperature has been reached. Shift into reverse gear only when the vehicle is stopped.

Warning!



On slippery road surfaces, never downshift in order to obtain braking action. This could result in drive wheel slip and reduced vehicle control. Your vehicle's ABS will not prevent this type of loss of control.

Deactivating steering wheel gearshift control

- ▶ Press the program mode selector switch repeatedly until the **S** or **C** for automatic shift program appears in the speedometer display field.

Automatic gear shifting is activated.



At each engine start, the transmission will go into the last automatic shift program mode selected (**S** or **C**). Program mode **M** is not stored and will not be recalled when the engine is restarted.

Good visibility

Information on the windshield wipers (▷ page 47) and for setting the rear view mirrors (▷ page 38) is found in the “Getting started” section.

Rear view mirror

Automatic antiglare rear view mirror

The reflection brightness of the exterior rear view mirror on the driver’s side and the inside rear view mirror will respond automatically to glare when

- the ignition is switched on, and
- incoming light from headlamps falls on the sensor in the inside rear view mirror.

The rear view mirror will not react if

- reverse gear is engaged
- the interior lighting is turned on

Warning!



The automatic antiglare function does not react if incoming light is not aimed directly at sensors in the inside rear view mirror.

The inside rear view mirror and the exterior rear view mirror on the driver’s side do not react, for example, if the rear window sun shade* is in raised position.

Glare can endanger you and others.

Warning!



In the case of an accident liquid electrolyte may escape from the mirror housing if the mirror glass breaks.

Electrolyte has an irritating effect. Do not allow the liquid to come into contact with eyes, skin, clothing, or respiratory system. In case it does, immediately flush affected area with water, and seek medical help if necessary.

Warning!



Exercise care when using the passenger side exterior rear view mirror. The mirror surface is convex (outwardly curved surface for a wider field of view). Objects in mirror are closer than they appear. Check your inside rear view mirror or glance over your shoulder before changing lanes.



Electrolyte drops coming into contact with the vehicle paint finish can be completely removed only while in the liquid state by applying plenty of water.

Good visibility

Parking position

The button is located on the left side of the dashboard.



1 Passenger-side exterior mirror

2 Driver's side exterior mirror

You can store a parking position for an exterior rear view mirror in the memory (▷ page 103).

- ▶ Make sure that the Mirror adjustment parking aid function, found under the Convenience submenu in the control system, is switched on (▷ page 135).
- ▶ Switch on ignition.
- ▶ Press button **1** for the passenger-side exterior rear view mirror.
- ▶ Place the gear selector lever in **R** Reverse.

The passenger-side mirror will be turned downward in the stored position.

The exterior rear view mirror returns to its previously stored driving position:

- 10 seconds after you put the gear selector lever out of position **R**
- immediately once you exceed a speed of approx. 6 mph (10 km/h)
- immediately when you press the button for driver's side mirror

Windshield wipers

Information on the windshield wipers is found in the “Getting started” section (▷ page 47).



Intermittent wiping is interrupted when the vehicle is at a standstill and a front door is opened.

A rain sensor automatically controls the windshield wipers depending on how wet the windshield is.

- ▶ Switch ignition on.
- ▶ Set the wiper switch to position **I** (▷ page 48).

After the initial wipe, pauses between wipes are automatically controlled by the rain sensor which monitors the wetness of the windshield.



To prevent the windshield wipers from being damaged, do not leave the wiper switch in intermittent setting when the vehicle is taken to an automatic car wash or when cleaning the windshield.

The switch should not be left in intermittent setting as the wipers will wipe the windshield once every time the engine is started. Dust that accumulates on the windshield might scratch the glass when wiping occurs on a dry windshield.



If intermittent wiping is on and you turn the key in the steering lock from position **1** to position **2** (▷ page 31) and keep the key in that position longer than 2 seconds, the wipe interval will be set to approx. 5 seconds.

Headlamp cleaning system*

The switch is located on the left side of the dashboard.



1 Headlamp washer switch

- ▶ Switch on ignition.
- ▶ Press switch **1**.

Good visibility

Sun visors

The sun visors protect you from sun glare while driving.

Warning!



Do not use the vanity mirror while driving.

Keep the mirrors in the sun visors closed while vehicle is in motion. Reflected glare can endanger you and others.

- ▶ Swing sun visors down when you experience glare.

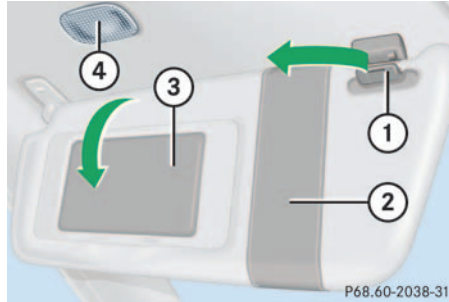

P68.60-2038-31

- 1 Mounting
 - 2 Sun visor
 - 3 Mirror cover
 - 4 Mirror lamp
- ▶ To use mirror, lift up cover **3**.

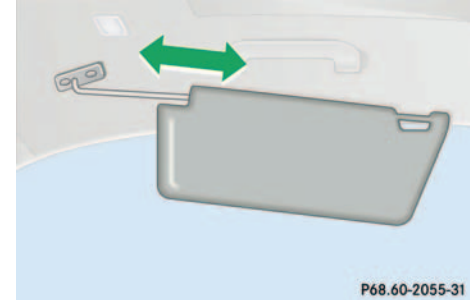

P68.60-2055-31

If sunlight enters through a side window:

- ▶ disengage sun visor from mounting **1**.
- ▶ pivot sun visor to the side.

The sun visors are extendable.

- ▶ Adjust the sun visors by pushing or pulling in the direction of the arrows.



If you disengage the sun visor from mounting **1**, mirror lamp **4** will switch off.

Rear window sunshade*

The switch is located in the center console.

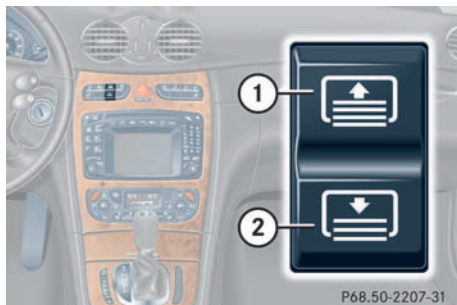

- ▶ Turn the key to starter switch position **1** or **2**. Vehicles with KEYLESS-GO*: press the start/stop button once or twice.
- ▶ Press the switch briefly at **1** to raise the sunshade.
- ▶ Press the switch briefly at **2** to lower the sunshade.

Always raise the sunshade fully for its support against the window frame.

Warning!



When operating the rear window sunshade, make sure that there is no danger of anyone being harmed by the raising or lowering procedure.

The raising or lowering procedure can be immediately halted by briefly pressing the upper or lower half of the switch.

Briefly press upper or lower half of the switch again to raise or lower the rear window sunshade completely.

Warning!



When leaving the vehicle, always remove the SmartKey from starter switch, and lock your vehicle. Do not leave children unattended in the vehicle, or with access to an unlocked vehicle. Unsupervised use of vehicle equipment may cause an accident and/or serious personal injury.

Controls in detail

Automatic climate control

Automatic climate control

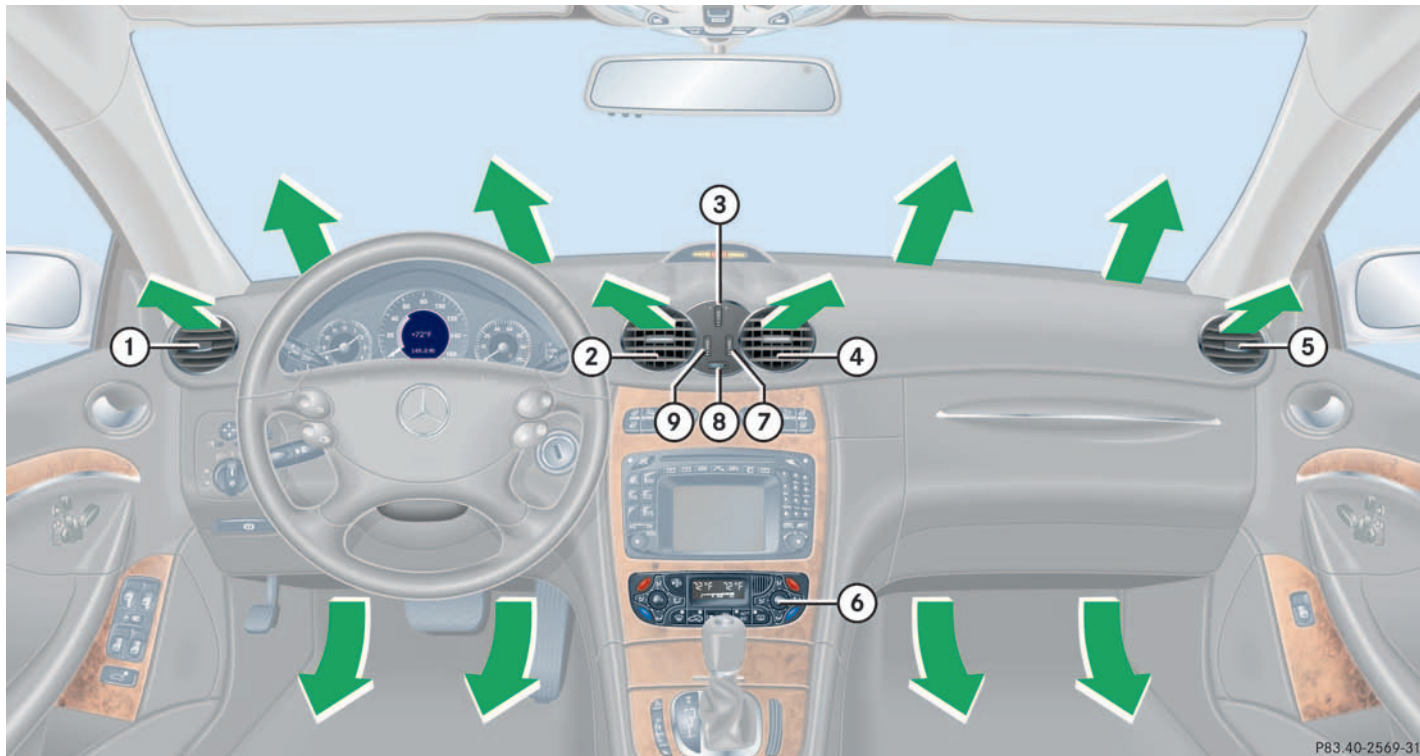

Automatic climate control

Item	Description
1	Left side air vent, adjustable
2	Left center air vent, adjustable
3	Air volume control for center air vents
4	Right center air vent, adjustable
5	Right side air vent, adjustable
6	Automatic climate control panel
7	Air volume control for far right air vent
8	Thumbwheel for lowering temperature, center and side air vents
9	Air volume control for far left air vent

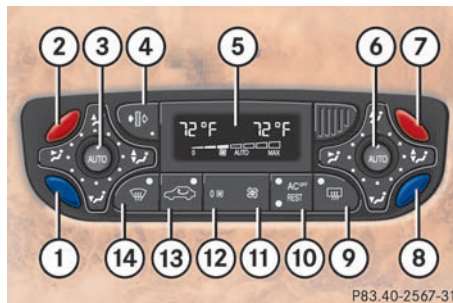

Automatic climate control panel

Item	Description
1	Temperature control, left, lowering
2	Temperature control, left, raising
3	Left-side air distribution (automatic or manual operation)
4	Activated charcoal filter
5	Display
6	Right-side air distribution (automatic or manual operation)
7	Temperature control, right, raising
8	Temperature control, right, lowering
9	Rear window defroster
10	AC cooling on/off Residual heat/ventilation
11	Air volume control
12	Automatic climate control on/off (complete system)
13	Air recirculation
14	Defrosting



For draft-free ventilation, move the sliders for the center air vents to the middle position.

Automatic climate control

The automatic climate control is operational whenever the engine is running. You can operate the climate control system in either the automatic or manual mode. The system cools or heats the interior depending on the selected interior temperature and the current outside temperature.

Nearly all dust particles, pollutants and odors are filtered out before outside air enters the passenger compartment through the air distribution system.

The air conditioning will not engage (no cooling) if the economy mode **AC^{OFF}** is selected (▷ page 163).

Warning!



Follow the recommended settings for heating and cooling given on the following pages. Otherwise the windows could fog up, impairing visibility and endangering you and others.



If the vehicle interior is hot, ventilate the interior before driving off.

Keep the air intake grille in front of the windshield free of snow and debris.

Do not obstruct air flow by placing objects on the air flow-through exhaust slots below the rear window.

Setting the temperature

Use temperature controls (▷ page 155) **1** and **2** for the left side or **7** and **8** for the right side to separately adjust the air temperature on each side of the passenger compartment. You should raise or lower the temperature setting in small increments, preferably starting at 72°F (22°C).



When operating the climate control system in automatic mode, you will only rarely need to adjust the temperature, air volume and air distribution.

Increasing

- ▶ Push temperature control **2** and/or **7**.
The automatic climate control system will correspondingly adjust the interior air temperature.

Decreasing

- ▶ Push temperature control **1** and/or **8**.
The automatic climate control system will correspondingly adjust the interior air temperature.





Adding outside air

- ▶ Turn thumbwheel **8** in dashboard (▷ page 154) to increase flow of outside air through air vents for center, left and right sides, as well as dashboard top center and rear passenger compartment.

Automatic climate control





Adjusting air distribution

Use the air distribution controls **7** and **9** (▷ page 154) to separately adjust the air distribution on each side of the passenger compartment. The following symbols are found on the controls:

Symbol	Function
	Directs air through the center, side and rear passenger compartment air vents
	Directs air to the windows
	Directs air into the entire vehicle interior
	Directs air to the footwells





Adjusting manually

- ▶ Press left or right **AUTO** button.



The **AUTO** pops out, the , ,  and  symbols are visible. Air distribution can be adjusted manually.

Adjusting automatically

- ▶ Press left or right **AUTO** button again.

The , ,  and  symbols are no longer visible. The air distribution is adjusted automatically.

Windshield fogged on the outside

- ▶ Switch the windshield wipers on.
- ▶ Switch to manual mode.
- ▶ Close the air vent at dashboard top center.
- ▶ Turn the air distribution control to  or .

Adjusting air volume

Adjusting manually





Seven blower speeds are available.

- ▶ Press left **0** or right  side of air volume control switch until the requested blower speed is attained.

The display *Auto* disappears and the automatic mode is switched off. The selected blower speed is shown in the display.

Adjusting automatically

- ▶ Press left or right **AUTO** button until it clicks in.

The , ,  and  symbols are no longer visible. The air volume is adjusted automatically.

Maximum cooling MAXCOOL

If the left and right air distribution controls as well as the airflow volume control are set to **AUTO** and there is a high need for cooling, the display “MAXCOOL” appears.

This provides the fastest possible cooling of the vehicle interior (when windows and sliding/pop-up roof are closed).

Defrosting



These settings should only be selected for a short time.

Activating

- ▶ Press button  (▷ page 155).

The indicator lamp on the button lights up.

Switch off air recirculation, if selected.

- ▶ Press button  (▷ page 155).

The indicator lamp on the button goes out.

- ▶ Close center air vents.
- ▶ Adjust side air vents upwards.

Deactivating

- ▶ Press button  (▷ page 155).

The indicator lamp on the button goes out. Defrosting is turned off.

Automatic climate control

Air recirculation mode

Switch to air recirculation mode to prevent unpleasant odors from entering the vehicle from the outside. This setting cuts off the intake of outside air and recirculates the air in the passenger compartment.

Warning!



When the outside temperature is below 41 °F (5 °C), only switch to air recirculation mode for short periods to prevent window fogging.

Activating

- ▶ Press button  (▷ page 155).

The indicator lamp on the button lights up.



If you keep button  pressed, the side windows and the sliding/pop-up roof* will be closed.

The air recirculation mode is activated automatically:

- at high outside temperatures
- if the concentration of carbon monoxide and nitrogen oxide in the outside air increases, for example in a tunnel

Please note that the charcoal filter must be activated (▷ page 161) for the air recirculation mode to be activated automatically.

If you have turned off the air conditioning system (▷ page 163) or the outside temperature is below 41 °F (5 °C), the air recirculation mode will not switch on automatically.

Deactivating

- ▶ Press button  (▷ page 155).

The indicator lamp on the button goes out.



If you keep button  pressed, the side windows and the sliding/pop-up roof will be returned to their previous position.

The air recirculation mode is deactivated automatically:

- after five minutes if the outside temperature is below approximately 41 °F (5 °C)
- after five minutes if the air conditioning is turned off
- after 30 minutes if the outside temperature is above approximately 41 °F (5 °C)

At outside temperatures above 79 °F (26 °C) the system will not automatically switch back to outside air. A quantity of outside air is added after approximately 30 minutes.

Charcoal filter

An activated charcoal filter markedly reduces bad odors and removes pollutants from air entering the passenger compartment.

Activating

- ▶ Press button  (▷ page 155).

The indicator lamp on the button lights up.



If you keep button  pressed, the side windows and the sliding/pop-up roof will be closed.

Deactivating

- ▶ Press button  (▷ page 155).

The indicator lamp on the button goes out.



If you keep button  pressed, the side windows and the sliding/pop-up roof will be returned to their previous position.

The system switches automatically to the air recirculation mode if the carbon monoxide (CO) or nitrogen oxide (NO_x) concentration of the outside air increases beyond a predetermined level.

The automatic air recirculation mode does not function if economy mode **AC^{OFF}** is selected or if the outside temperature has fallen below 41 °F (5 °C).

The activated charcoal filter should be switched off when windows fog up on the inside, or if the passenger compartment needs to be quickly heated or cooled down.

Automatic climate control

Rear window defroster

The rear window defroster uses a large amount of power. To keep battery drain to a minimum, switch off the defroster as soon as the rear window is clear. The defroster is automatically deactivated after approximately 6 to 17 minutes of operation depending on the outside temperature.

Activating

- ▶ Press button  (▷ page 155).

The indicator lamp on the button lights up.

Deactivating

- ▶ Press button  (▷ page 155) again.

The indicator lamp on the button goes out.

Warning!



Any accumulation of snow and ice should be removed from the rear window before driving. Visibility could otherwise be impaired, endangering you and others.



If the rear window defroster switches off too soon and the indicator lamp starts blinking, this means that too many electrical consumers are operating simultaneously and there is insufficient voltage in the battery. The system responds automatically by deactivating the rear window defroster.

As soon as the battery has sufficient voltage, the rear window defroster automatically turns itself back on.

Air conditioning

The air conditioning is operational while the engine is running and cools the interior air to the temperature set by the operator.



Condensation may drip out from underneath the vehicle. This is normal and not an indication of a malfunction.

Deactivating

It is possible to deactivate the air conditioning (cooling) function of the automatic climate control system. The air in the vehicle will then no longer be cooled or dehumidified.

- ▶ Press button **AC^{OFF}** (▷ page 155).

The indicator lamp on the button **AC^{OFF}** lights up.

Activating

Moist air can fog up the windows. You can dehumidify the air with the air conditioning.

- ▶ Press **AC^{OFF}** again (▷ page 155).

The indicator lamp on the button **AC^{OFF}** goes out.

The air conditioning system uses the refrigerant R134a. This refrigerant is free of CFCs which are harmful to the ozone layer.



If the **AC^{OFF}** button on the automatic climate control panel starts to blink, this indicates that the air conditioning system is losing refrigerant. The compressor has turned itself off. The air conditioning cannot be turned on again.

Have the air conditioning system checked at the nearest authorized Mercedes-Benz Center.

Residual heat and ventilation*

With the engine switched off, it is possible to continue to heat or ventilate the interior for up to 30 minutes. This feature makes use of the residual heat produced by the engine.

Activating

- ▶ Turn the key in the starter switch to position **1** or remove it from the starter switch.
- ▶ Press button **REST** (▷ page 155).

The indicator lamp on button **REST** comes on.

Automatic climate control

Deactivating

- ▶ Press button **REST** (▷ page 155).

The indicator lamp on button **REST** goes off.

The residual heat is automatically turned off:

- when the ignition is switched on
- after about 30 minutes
- if the battery voltage drops



How long the system will provide heating depends on the coolant temperature and the temperature set by the operator. The blower will run at speed setting **1** regardless of the air distribution control setting.

Rear passenger compartment adjustable air vents

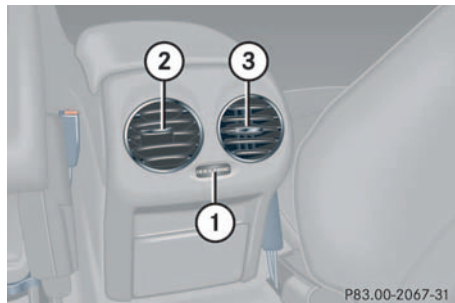

- 1** Thumbwheel for center air vents with adjustable booster blower
- 2** Left center air vent
- 3** Right center air vent

To open center air vents and to adjust the booster blower:

- ▶ Turn thumbwheel **1**.



The booster blower allows airflow speed to the rear passenger compartment to be increased at four different levels.

The temperature at the air vents for rear passenger compartment **2** and **3** is the same as at the dashboard center air vents.

Audio system

Audio and telephone, operation

These instructions are intended to help you become acquainted with your Mercedes-Benz car radio. They contain useful tips and a detailed description of the user functions.

Warning!



In order to avoid distraction which could lead to an accident, system settings should be entered with the vehicle at standstill and systems should be operated by the driver only when traffic conditions permit. Always pay full attention to traffic conditions first before operating system controls while driving.

Bear in mind that at a speed of just 30 mph (approximately 50 km / h), your car is covering a distance of approximately 44 feet (approximately 13.5 m) every second.¹

¹ The right to correct errors and make technical amendments is reserved.

Operating safety

Warning!



Any alternations made to electronic components can cause malfunctions.

The radio, cassette deck, CD changer¹ and telephone* are interconnected. Therefore, when one of the components is defective or has not been removed / replaced properly this may impair the function of other components.

These malfunctions might seriously impair the operating safety of your vehicle.

We recommend that you have any service work or alternations on electronic components done in an authorized Mercedes-Benz Center.

¹ Optional equipment

Dolby and the double-D symbol  are trademarks of Dolby Laboratories Licensing Corporation. The Dolby noise reduction system is manufactured under licence from Dolby Laboratories Licensing Corporation.

Audio system

Operating and display elements

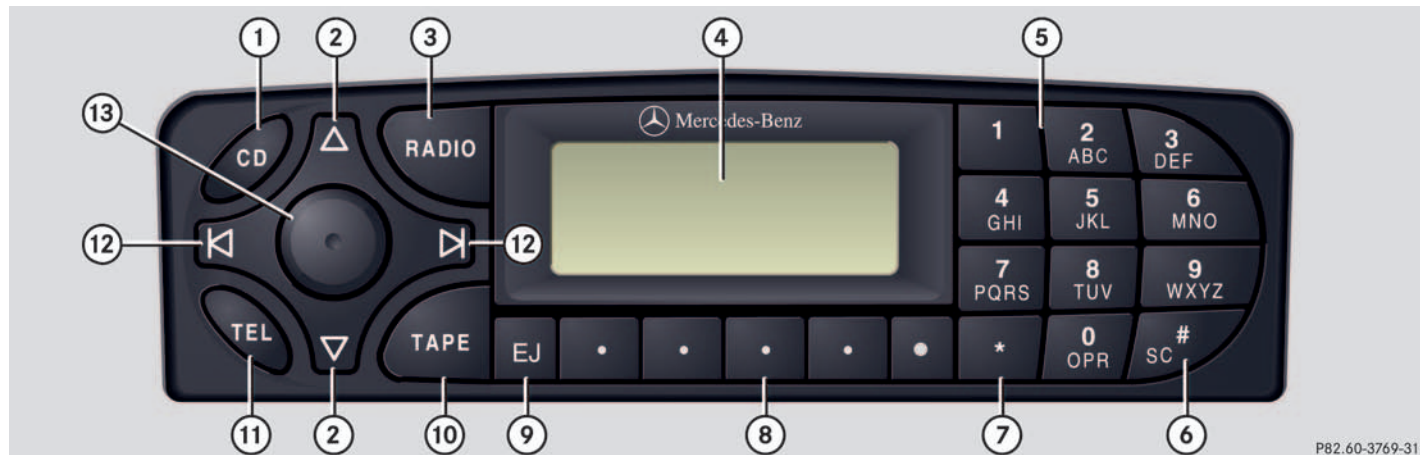

P82.60-3769-31

Audio system

Item	Page
1 CD mode selector	178
2 Manual tuning (radio)	172
Fast forward/reverse (cassette, CD)	176, 180
Speed dialing memory (telephone*)	185
3 Radio mode selector	171
4 Display	

Item	Page
5 Alpha-numeric keypad	
Band selection, station buttons (radio)	171
CD selection (CD)	179
Telephone number entry, retrieving speed dialing memory (telephone*)	182
6 Scanning (radio, cassette, CD)	173, 176, 180
7 Function button	172
8 Soft keys	168

Item	Page
9 Cassette eject	175
10 Cassette mode selector	174
11 Telephone* mode selector	182
12 Seek tuning (radio)	172
Track search (cassette, CD)	175, 180
Speed dialing memory (telephone*)	185
13 On /off	168
Volume	168

Audio system

Button and soft key operation

In these instructions, the alpha-numeric keypad (right side of radio face) and the function buttons (left side of the radio face) are referred to as “buttons” and the four keys under the display are referred to as “soft keys”.



Do not press directly on the radio display face.

Operation

Switching on/off

Switching on:

- ▶ Turn the key to position **1** or **2** in the starter switch.

or

- ▶ Turn control knob .



If the radio is turned on without the key in the ignition, it will automatically turn off again after approx. 30 minutes.

Switching off:

- ▶ Remove the key from the starter switch.

or

- ▶ Turn control knob .

Adjusting the volume

- ▶ Turn control knob .

The volume will increase or decrease according to the direction turned.



If your vehicle was equipped with a telephone* and voice control system*, and both are connected to the car radio, their volume can be adjusted separately while the telephone* is being used or the voice control system* is activated.

Adjusting audio functions

In radio, cassette and CD mode, press the AUD key to call up the bass, treble, balance and fader functions.

Settings for bass and treble are stored separately for the AM (medium wave, long wave, short wave) and FM (ultra-short wave) frequency bands, cassette mode and CD mode.

Bass

- ▶ In radio, cassette and CD mode, press the **AUD** key repeatedly until **BASS** appears on the display.



- ▶ Press the **+** or **-** key to increase or decrease the tone level accordingly.
or
- ▶ Press both the **+** and **-** keys simultaneously to reset the bass tones to the center (flat) level.

Treble

- ▶ In radio, cassette and CD mode, press the **AUD** key repeatedly until **TREBLE** appears on the display.



- ▶ Press the **+** or **-** key to increase or decrease the tone level accordingly.
or
- ▶ Press both the **+** and **-** keys simultaneously to reset the treble tones to their center (flat) level.

Fader



Your vehicle may or may not have the fader function, depending on the vehicle equipment and model.

- ▶ In radio, cassette and CD mode, press the **AUD** key repeatedly until **FADER** appears on the display.



- ▶ Press the **F** or **R** key to shift the sound accordingly.
or
- ▶ Press both the **F** and **R** keys simultaneously to reset the fader to its center level.

Audio system

Balance

- ▶ In radio, cassette and CD mode, press the **AUD** key repeatedly until **BALANCE** appears on the display.

```
FM BALANCE
.....|.....
<L EXT AUD R>
```

- ▶ Press the **L** or **R** key to shift the sound accordingly.
or
- ▶ Press both the **L** and **R** keys simultaneously to reset the balance to its center level.

Returning audio functions to factory settings

```
RESET
```

- ▶ In radio, cassette and CD mode, press and hold the **AUD** key longer than two seconds. **RESET** will appear on the display.

All settings for bass, treble and balance are returned to center and the volume is set to a predefined level.

Audio system sound selection (EXT)*

- ▶ In radio, cassette and CD mode, press the **AUD** key.

The sound settings menu appears on the display.

- ▶ Press the **EXT** key.

```
SOUND
DRIVER
DRV SP AMB OFF
```

- ▶ Press one of the function keys.

You can select from among the following settings:

- **DRV**: The tone level is set to the “Driver” position, sound is directed toward the passengers.

- **SP:** The tone level is set for “Speech”, optimizing the sound for spoken language.
- **AMB:** The tone level is set for “Ambience”, producing a three-dimensional sound.
- **OFF:** The audio system sound selection is turned off.

Telephone* muting

If a telephone has been installed in the vehicle, the radio will switch to telephone mode when a call is received. The current audio source is muted.

Radio mode

Selecting radio mode

- ▶ Press the **RADIO** button.

Selecting the band

You can select from among FM, AM or WB frequency bands.

FM frequency band:

FM (ultra-short wave) 87.9.....107.9 MHz

AM frequency bands:

MW (medium wave) 530.....1710 KHz

WB (long wave) approx. 162 KHz

Selecting FM band

- ▶ Press the **FM** function button.

FM appears in the upper right-hand corner of the display.

Selecting AM band

- ▶ Press the **AM** function button.

AM appears in the upper right-hand corner of the display.

Selecting a station

The following options are available for selecting a station:

- Direct frequency band input
- Manual tuning
- Automatic seek tuning
- Scan tuning
- Station buttons
- Automatic station memory (Autostore)

Audio system

Direct frequency input (AM and FM only)

Select the desired frequency band.

```
FM5 ST
 95.5 MHz
AM WB AUD AS
```

- ▶ Press the ***** button.
- ▶ Enter the desired frequency with the buttons **1** to **0**.



You can only enter frequencies within the respective waveband.

If a button is not pressed within four seconds, the radio will return to the last tuned station.

Manual tuning

- ▶ Select the desired band.

```
FM1
 95.5 MHz
AM WB AUD AS
```

- ▶ Press and hold either the **▲** or **▼** button until the desired frequency is reached.

Step-by-step station tuning takes place in ascending or descending order of frequency. The first three tuning steps will take place without muting. Afterward, the radio will be muted and high-speed tuning will take place until the button is released.

Automatic seek tuning

- ▶ Select the desired frequency band.

```
FM
SEARCH
AM WB AUD AS
```

- ▶ Press either the **▶** or **◀** button.
The radio will tune to the next receivable station at a higher or lower frequency.

Scan tuning

- Starting scan tuning
 - ▶ Select the desired frequency band.

FM1
95.5 MHz
AM WB AUD AS

- ▶ Press the **SC#** button.
SC will appear on the display. The radio briefly tunes into all receivable stations on the band selected. The first scan will tune only the stations with a strong signal. The second scan will tune every receivable station.
- Ending scan tuning
 - ▶ Press the **SC#** button or the **▲**, **▼**, **▶** or **◀** button.
SC disappears from the display.

Station memory

You can store 10 AM and 10 FM stations.

- Storing stations
 - ▶ Tune in the desired station.
 - ▶ Press and hold the desired station button **1** to **0** until a brief signal tone is heard.
The frequency is stored on the selected station button.
- Retrieving a station from memory
 - ▶ Press the desired station button **1** to **0**.

Storing stations automatically (Autostore)

The Autostore memory function provides an additional memory level. The station memory for manually stored stations is not erased.

- Calling up the Autostore memory level
 - ▶ Briefly press the **AS** key.
AS appears on the display in inverted-color format.
The radio finds the 10 stations with the strongest signals. These stations are stored on the station buttons **1** to **0** in the order of signal strength.
- Retrieving a station from memory
 - ▶ Press the desired station button **1** to **0**.
- Leaving the Autostore memory level
 - ▶ Press the **AS** key.
AS appears on the display in inverted-color format.

Audio system

Weather band

- ▶ Press the **WB** key.

The last weather band station is tuned in.

- ▶ Select the desired weather band station with buttons **1** to **7**.

If a station cannot be tuned in, a scan is automatically started.

- ▶ Press the **▶** or **◀** button. The next receivable weather band station is tuned in.

Cassette mode

Playing cassettes

- ▶ Press the **EJ** button.

The display folds down and the cassette slot becomes visible.

- ▶ Press the cassette into the slot until it engages and tap it gently.

The cassette will be pulled in automatically. The system switches to cassette mode (TAPE). Track 1 will be played and **SIDE 1** appears in the display. Track 1 is the side of the cassette which is facing upward. The cassette deck will automatically detect the type of tape.

- ▶ Fold the display back up and press gently on the display frame to lock in place.



Do not press directly on the display face.

or

- ▶ If a cassette is already in the mechanism, press the **TAPE** button.



A warning signal will sound after 20 seconds if the display is left in the down position. If the display is not closed, a warning signal will sound and the radio will be muted.

Track selection

TAPE
SIDE 1
TRK NR AUD SB

- ▶ Press the **TRK** key.

Upon selection of the track, the display shows **SIDE 1** or **SIDE 2** correspondingly.

- ▶ You can switch track sides at any time. The track side will be changed automatically at the end of the tape.

Cassette eject

- ▶ Press the eject button .

The display will fold down and the cassette will be ejected. The system will switch back to radio mode automatically.

- ▶ Fold the display back up.



The cassette will not be ejected when the system is switched off or switched to another operating mode.

Track search**Track search forward**

TAPE
SEEK FWD
TRK NR AUD SB

- ▶ Press the  button.

SEEK FWD will appear in the display. The track search will run the tape forward to the start of the next track and switch to play.



The cassette will not be ejected when the system is switched off or switched to another operating mode.

Track search backward

- ▶ Press the  button.

SEEK RWD will appear on the display. The track search will run the tape backward to the start of the track currently playing and switch to play.

Stopping track search

- ▶ Press the , ,  or  button.

The cassette will switch over to Play.

Audio system

Scanning

```
TAPE SC
SEEK FWD
TRK NR AUD SB
```

- ▶ Press the **SC#** button.

SC will appear on the display.

Each track on the cassette will be played briefly in ascending order.

Stopping scan:

- ▶ Press the **SC#**, **△**, **▽**, **▶** or **◀** button.

The system will switch to Play.

Fast forward/reverse

Starting cassette fast forward mode:

```
TAPE
FORWARD
TRK NR AUD SB
```

- ▶ Press the **△** button.

FORWARD will appear on the display.

Starting cassette fast reverse mode:

- ▶ Press the **▽** button.

REWIND will appear on the display.

The cassette will automatically switch over to the play mode at the end or beginning of the tape.

Stopping the cassette fast forward/reverse mode:

- ▶ Press the **△**, **▽**, **▶** or **◀** button.

The cassette will switch over to the play mode.

Skipping blank sections (skip blank)

Switching on the skip blank function



TAPE
SIDE 1
TRK NR AUD SB

- ▶ Press the SB key.

SB appears on the display in inverted-color format.

If the system does not detect a sound signal, the cassette will automatically fast forward to the next sound signal.

Switching off the skip blank function

- ▶ Press the SB key.

The inverted-color SB display disappears.

Dolby NR¹ (noise reduction system)

To enable optimum sound reproduction of cassettes recorded using Dolby B NR¹, the Dolby NR¹ system should be switched on.



The Dolby NR¹ function should be switched off when playing cassettes not recorded with Dolby B NR¹.

Switching on

- ▶ Press the NR key.

NR appears on the display in inverted-color format.

Switching off

- ▶ Press the NR key again.

The inverted-color NR display disappears.

¹ DOLBY and the double-D symbol  are trademarks of Dolby Laboratories Licensing Corporation.

The Dolby noise reduction system is manufactured under license from Dolby Laboratories Licensing Corporation.

Audio system

CD changer* operating mode

General notes

Should excessively high temperatures occur while in CD mode, CD TEMP HIGH will appear on the display and muting will take place. The unit will then switch back to the last operating mode used until the temperature has decreased to a safe operating level.

Should excessively low temperatures occur while in CD mode, CD TEMP LOW will appear on the display, but the CD will continue to play.

Handle CDs carefully to prevent interference during playback. Avoid fingerprints and dust on CDs. Do not write on CDs or apply any label or other material to them.

Only use original CDs. Using copied CDs may create problems during playback.

Clean CDs from time to time with a commercially available cleaning cloth. No solvents, anti-static sprays, etc. should be used for cleaning. Replace the CD in its case after use. Protect CDs from heat and direct sunlight.



Only use CDs, which bear the label shown and that conform to the compact disc digital audio standard (IEC 60908).

Use of CDs which do not meet this standard may cause damage to the CD changer. Do not play single-CDs (80 mm) with an adapter.

Warning!



The CD changer* is a Class 1 laser product. There is a danger of invisible laser radiation if the cover is opened or damaged. Do not remove the cover. The CD changer* does not contain any parts which can be serviced by the user. For safety reasons, have any service work which may be necessary performed only by qualified personnel.

Operational readiness of CD changer

If a CD changer has been installed in the system, it can be operated from the front control panel of the radio. A loaded magazine must be installed for CD playing.

Loading/unloading the CD magazine

- ▶ Slide the changer door to the right and press the eject button .
- ▶ The magazine will be ejected.



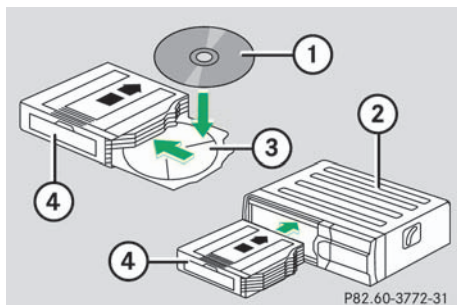

- 1 CD
- 2 CD changer
- 3 CD tray
- 4 CD magazine

- ▶ Remove the magazine and pull the CD tray fully out.
- ▶ Place the CD in the recess of the tray, label side up.
- ▶ Push the tray into the magazine in the direction shown by the arrow.



CDs which have been inserted improperly or are unreadable will not be played.

- ▶ Push the magazine into the CD changer in the direction shown by the arrow and close the sliding door.

Playing CDs

- ▶ Press the **CD** button.

CD will appear on the display.

The CD most recently listened to will then start playing at the point where it was last switched off.

After the last track on a CD has finished, the next CD is automatically played.

Selecting CDs

```
CD1
NO CD3
RDM RPT AUD
```

- ▶ You can select from among the CDs in the CD magazine using buttons 1 to 6.

CD and the magazine slot number of the selected CD appear on the display. The number of the current track is displayed after TRACK.

If there is no CD in the selected magazine slot, NO CD appears on the display with the corresponding slot number.

Audio system

Skipping tracks forward/backward

Skipping tracks forward:



- ▶ Press the  button.

The next track will be played.

Skipping tracks backward:

- ▶ Press the  button.

If the track has been playing for more than 10 seconds, it will revert to the start of that track. If it has been playing for less than 10 seconds, it will revert to the preceding track.

Repeated pressing of the  or  button will result in multiple tracks being skipped.

Fast forward/reverse

Fast forward:

- ▶ Press and hold the  button until the desired location has been reached.

Reverse:

- ▶ Press and hold the  button until the desired location has been reached.



The relative time of the track is shown on the display during search.

Scanning





Starting scan:

- ▶ Press the  button.

SC appears in the display.

Each track on the current CD will be played for approx. eight seconds in ascending order.

Ending scan:

- ▶ Press the , , ,  or  button.

Random play

The random play function (RDM) plays the tracks on the current CD in random order.

Switching on random play:

```
CD1
TRACK 10
RDM RPT AUD T
```

- ▶ Press the RDM key.

RDM appears on the display in inverted-color format.

Switching off random play:

- ▶ Press the RDM key again.

The inverted-color RDM display disappears.

Repeat

The repeat function (RPT) repeats the current track.

Switching on repeat:

```
CD1
TRACK 1
RDM RPT AUD T
```

- ▶ Press the RPT key.

RPT appears on the display in inverted-color format.

Switching off repeat:

- ▶ Press the RPT key again.

The inverted-color RPT display disappears.



The Random play and Repeat function cannot be used simultaneously.

Track and time display

```
CD3
T01 / 02:46
RDM RPT AUD T
```

- ▶ Press the T key.

The number of the track being played and the elapsed playing time appear in the display.

- ▶ Press the T key again.

The total number of tracks and the total playing time of the CD appear in the display.

The CD main menu appears again after eight seconds.

Audio system

Telephone* operation

Various car telephone functions and operating steps for the car telephone can be performed and displayed via the audio system.

Further operating instructions not covered here can be found in the operating instructions for the multifunction steering wheel, voice control system* and car telephone.

Switching on the telephone

- ▶ Press the **TEL** button.
- ▶ If you have programmed an unlock code for the telephone, you must input the code now.
- ▶ Press the **OK** key.

The telephone is unlocked. If you enter the wrong code, you must re-enter the correct code.

Switching off the telephone

- ▶ Press the **TEL** button repeatedly until **PHONE OFF** appears in the display.

The receiving symbol in the display disappears.

Adjusting the volume

- ▶ Turn control knob  during telephone operation.

The volume increases or decreases depending on the direction in which the knob is turned.



The volume can be adjusted separately for the telephone, voice control system* and radio.

Placing a call

Entering a telephone number and starting the dialing process



- ▶ Enter the desired telephone number using buttons **1** to **0**.





The number can have up to 32 digits, but only 17 of these are visible on the display.

- ▶ If necessary, correct the number entered with the **CLR** key. Press the key briefly to delete the last digit entered, press the key and hold to delete the complete number.
- ▶ After the correct telephone number has been entered, press the **SND** key.

Telephone book

The numbers stored in the telephone book can be called up by either name or number.

Calling up the telephone book

- ▶ Press either the , ,  or  button.

Switching between name search and number search



- ▶ Press the ABC key.

The name search is called up.

or



- ▶ Press the NUM key.

The number search is called up.

Searching and calling up telephone book entries by name



- ▶ Press the ABC key.

The current name is marked on the display.

- ▶ Press either the  or  button.

The stored entries are selected according to alphabetical order of initial letters.

or

- ▶ Press the  or  button.

The stored entries are selected in increments of 4.

or

- ▶ Press the desired numerical key **2** to **9**.

The stored entries are selected according to alphabetical initial letters (e.g. for B -Brown, press button **2** twice).



A number of characters and symbols cannot be shown on the display for technical reasons, they have been replaced with spaces.

Audio system

Searching and selecting telephone book entries by number



```
S_ [signal] M12
7248711353
SND ABC CLR END
```

- ▶ Press the NUM key.

The current number is marked in the display.

- ▶ Press either the  or  button.

The stored entries are selected according to numerical order.

or

- ▶ Press the  or  button.

The stored entries are selected in increments of 4 (e.g. Entry M1, Entry M5, etc.).

Starting dialing process

- ▶ Once you have selected a number, press the SND key.

Repeat dialing

If, for example, the number dialed is busy, you can again place calls to the last 10 telephone numbers dialed using the repeat dialing function.





Manual repeat dialing (redial)



```
S_ [signal] M12
7248711353
SND ABC CLR END
```

- ▶ Press the SND key.

The last number dialed is shown in the display.

- ▶ Select the desired telephone number using the , ,  or  button.

The abbreviation L and the number of the entry are shown in the top line of the display.

- ▶ When you have selected a number, press the SND key.

The call will then be placed.

Automatic repeat dialing (redial)

If a call cannot be connected, press the SND key.

REDIAL will appear on the display and repeated attempts to place the call will be made for the next four minutes.

Quick dialing



```
S_ [signal] M12
153
SND RCL CLR END
```

- ▶ Enter the previously selected 3-digit (1-999) number of the entry using the number keys 1 to 0.

- ▶ Press the RCL key.

The telephone number stored under that entry will be dialed.

- ▶ Press the SND key.

The call will be placed.

Speed dialing

- ▶ Input the desired entry number using the number keys **1** to **0**.

A maximum of two digits can be entered.

If necessary, correct the last number entered with the CLR key.

- ▶ Press the **SND** key.

The telephone number stored under that entry will be dialed. The number, **L** and the full entry number will be shown in the display.

Express dialing

- ▶ Press one of the desired number buttons **1** to **0** longer than one second.

The telephone number saved under that number will be dialed.



Please be aware that button **1** might already be reserved for an emergency call number.

Emergency call

- ▶ Press button **1** longer than one second.
- ▶ A call will be placed to the saved number (e.g. 911).



Please be aware that the 911 emergency call system is a public service. Using it without due cause is a criminal offense.

You can make an emergency call to an emergency rescue station with a mobile communications network.

The emergency call will be placed as long as the corresponding mobile communications network is available. To do this, switch the telephone on if not already done so.

The call will also be placed if the unlock-code is not entered.

Emergency calls may not be possible with all telephone networks or if certain network services and/or telephone functions are active. Check with your local network operation company. It may take some time to set up an emergency call.

To use this function you must ensure that the number stored in memory location 1 is the number to be dialed in case of emergency.

```

S [signal bars] ROAM
SYSTEM BUSY
SND          END
  
```

If an emergency call cannot be connected, the message **SYSTEM BUSY** appears.

Audio system

Accepting an incoming call

Accepting an incoming call in telephone mode

With an incoming call, a ringing tone can be heard and the caller's telephone number, or the name under which this telephone number has been saved in the telephone book, appear on the display. If the caller's number is not transmitted, CALL will appear in the display.

- ▶ Press the SND key to accept the call.

Accepting an incoming call in cassette, CD or radio mode

If the telephone is activated in the background (receiving symbol S visible on display), the audio source is muted when a call is received. The ringing tone is heard and the caller's telephone number or the name under which this telephone number has been saved in the telephone book appear on the display. If the caller's number is not transmitted, CALL appears in the display.

- ▶ Press the SND key to accept the call.

Muting a call

It is possible to silence a call, the caller is then no longer able to hear you.

Muting

- ▶ Press the MUT key.

Unmuting

- ▶ Press the MUT key again.

Terminating a call

- ▶ Press the END key.
- ▶ The current call is disconnected.

Call waiting

If you receive another call during an already active call, you can accept the second call and switch between the two.

Accepting a second call

- ▶ Press the SND key.

You are connected with the second caller, the first call is muted.

Switching between the calls

- ▶ Press the SND key again.

Terminating the second call

- ▶ Press the END key.

The current call will be terminated. You are connected with the muted call again.

Power windows

Opening and closing the windows

The side windows can be opened and closed electrically. The switches for all the side windows are on the driver's door. The switches for the respective windows are on the front passenger door and on the rear side trim panels.

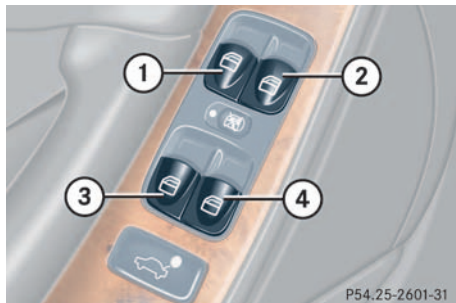

- 1 Left front window
- 2 Right front window
- 3 Left rear window
- 4 Right rear window

Warning!



When closing the windows, make sure that there is no danger of anyone being harmed by the closing procedure.

The closing of the door windows can be immediately halted by releasing the switch, or, if switch was pulled past the resistance point and released, by either pressing or pulling the respective switch.

If the window encounters an obstruction that blocks its path in a circumstance where you pulled the switch past the resistance point and released it to close the window, the automatic reversal function will stop the window and open it slightly.

If the window encounters an obstruction that blocks its path in a circumstance where you are closing the window by pulling the switch to its resistance point and holding it there, by pressing and holding button  on the SmartKey, or by pressing and holding the lock button (vehicles with KEYLESS-GO*) on the door handle,

the automatic reversal function will not operate.

When leaving the vehicle, always remove the key from starter switch, take the SmartKey with KEYLESS-GO* (if so equipped) with you, and lock your vehicle. Do not leave children unattended in the vehicle, or with access to an unlocked vehicle. Unsupervised use of vehicle equipment can cause an accident and/or serious personal injury.

- ▶ Turn key in the starter switch to position 1 or 2.

Opening the windows

- ▶ Press switch to resistance point.

The window will move downwards until you release the switch.

Closing the windows

- ▶ Pull on switch.

The window will move upwards until you release the switch.

Power windows

If you pull and hold the switch up when closing the window, and upward movement of the window is blocked by some obstruction including but not limited to arms, hands, fingers etc., the automatic reversal will not operate.

Fully opening windows

- ▶ Press switch past resistance point and release.

The window opens completely.

Fully closing windows

- ▶ Pull switch past resistance point and release.

The window closes completely.

If the upward movement of the window is blocked during the closing procedure, the window will stop and open slightly.

Warning!



Driver's door only:



If within five seconds you again pull the switch past the resistance point and release, the automatic reversal will not function.

Stopping windows

- ▶ Press or pull respective switch again.



You can also open or close the windows using the:

- SmartKey, see below
- button  in the control panel of the automatic climate control (> page 155).
- button  in the control panel of the automatic climate control (> page 155).



Opening and closing the windows with the SmartKey

The sliding/pop-up roof will also be opened or closed when you operate the power windows with the key.

Warning!



Never operate the windows or sliding/pop-up roof if there is the possibility of anyone being harmed by the opening or closing procedure.

In case the procedure causes potential danger, the procedure can be immediately halted by releasing the remote control button. To reverse direction of movement press  for opening or  for closing.



- ▶ Aim transmitter eye at the front door handle.

Opening (Summer opening feature)

- ▶ Press and hold button  after unlocking the vehicle.
The windows and sliding/pop-up roof begin to open after approximately one second.
- ▶ Release transmit button to interrupt procedure.

Closing (Convenience feature)

- ▶ Press and hold button  after locking the vehicle.
The windows and sliding/pop-up roof begin to close after approximately one second.
- ▶ Release transmit button to interrupt procedure.

Ensure that all side windows and the sliding/pop-up roof are properly closed before leaving the vehicle.

Closing the side windows and sliding/pop-up roof with KEYLESS-GO

- ▶ Press and hold lock button at door (▷ page 53) until the side windows and the sliding/pop-up roof are closed.

Warning!



When closing the windows and the sliding/pop-up roof, be sure that there is no danger of anyone being harmed by the closing procedure.

If potential danger exists, proceed as follows:

- Release the lock button.
- Pull on the door handle and hold firmly. The side windows and the sliding/pop-up roof will open for as long as the door handle is held but the door not opened.

Synchronizing power windows

The power windows must be resynchronized each time after the battery has been disconnected:

- ▶ Pull the power window switches until the side windows are closed and hold the switches for approximately one second.

Sliding/pop-up roof*

Sliding/pop-up roof*

Opening and closing the sliding/pop-up roof

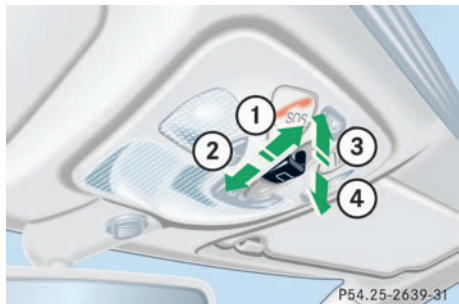

- 1 Slide roof open
- 2 Slide roof closed
- 3 Raise roof at rear
- 4 Lower roof at rear

With the roof closed or tilted open, a screen can be slid into the roof opening to guard against sun rays. When sliding the roof open, the screen will also retract.

Warning!



When closing the sliding/pop-up roof, make sure that there is no danger of anyone being harmed by the closing procedure.

The closing procedure of the sliding/pop-up roof can be immediately reversed by either moving the switch in any direction, or pressing button  on the key and holding it.

When leaving the vehicle, always remove the key from starter switch, take the SmartKey with KEYLESS-GO* (if so equipped) with you, and lock your vehicle. Do not leave children unattended in the vehicle, or with access to an unlocked vehicle. Unsupervised use of vehicle equipment may cause an accident and/or serious personal injury.

Opening and closing the sliding/pop-up roof

- ▶ Turn the key in the starter switch to position **1** or **2** or press the KEYLESS-GO* start/stop button.
- ▶ To open, close, raise or lower the sliding/pop-up roof, move the switch to resistance point in the required direction. Release the switch when the roof has reached the required position.

Opening and closing the sliding/pop-up roof automatically

- ▶ Move the switch past resistance point in the direction required and release. The sliding/pop-up roof opens or closes completely.



Stopping the sliding/pop-up roof

- ▶ Move the switch in any direction.

If the movement of the sliding/pop-up roof is blocked during the closing procedure, the roof will stop and reopen slightly.



You can also open or close the sliding/pop-up roof using the:

- SmartKey (▷ page 188)
- button  in the control panel of the automatic climate control (▷ page 155)
- button  in the control panel of the automatic climate control (▷ page 155)



To avoid damaging the seals, do not transport any objects with sharp edges which can stick out of the sliding/pop-up roof.

The sliding/pop-up roof can be opened or closed manually should an electrical malfunction occur (▷ page 314).

Opening and closing the sliding/pop-up roof with the SmartKey

The power windows will also be opened or closed when you operate the sliding/pop-up roof with the key.

Warning!



Never operate the windows or sliding/pop-up roof if there is the possibility of anyone being harmed by the opening or closing procedure.

In case the procedure causes potential danger, the procedure can be immediately halted by releasing the remote control button.

To reverse direction of movement press



for opening or



for closing

- ▶ Aim transmitter eye at the front door handle.

Opening

- ▶ Press and hold button  after unlocking the vehicle.

The windows and sliding/pop-up roof begin to open after approximately one second.

- ▶ Release transmit button to interrupt procedure.

Sliding/pop-up roof*

Closing

- ▶ Press and hold button  after locking the vehicle.

The windows and sliding/pop-up roof begin to close after approximately one second.

- ▶ Release transmit button to interrupt procedure.

Ensure that all side windows and the sliding/pop-up roof are properly closed before leaving the vehicle.

Closing the side windows and sliding/pop-up roof with KEYLESS-GO

- ▶ Press and hold lock button at door (▷ page 53) until the side windows and the sliding/pop-up roof are closed.

Warning!



When closing the windows and the sliding/pop-up roof, be sure that there is no danger of anyone being harmed by the closing procedure.

If potential danger exists, proceed as follows:

- Release the lock button.
- Pull on the door handle and hold firmly. The side windows and the sliding/pop-up roof will open for as long as the door handle is held but the door not opened.

Synchronizing the sliding/pop-up roof

The power sliding/pop-up roof must be re-synchronized each time after:

- the battery has been disconnected
 - the sliding/pop-up roof has been closed manually
 - the sliding/pop-up roof does not open smoothly
 - a malfunction
- ▶ Press the switch in direction **3**.
 - ▶ Wait until the sliding/pop-up roof is raised and hold the switch down for approx. one second.

Driving systems

The driving systems of your vehicle are described on the following pages:

- Cruise control and Distronic*, with which the vehicle can maintain a preset speed
- Parktronic*, which serves as a parking assistant.

The BAS, ABS and ESP driving systems are described in the “Safety and Security” section (▷ page 74).

Cruise control

Cruise control automatically maintains the speed you set for your vehicle.

Use of cruise control is recommended for driving at a constant speed for extended periods of time. You can set any speed over 20 mph (30 km/h).

The cruise control function is operated by means of the cruise control lever.

The cruise control lever is the uppermost lever found on the left-hand side of the steering column (▷ page 20).

Warning!



Cruise control is a convenience system designed to assist the driver during vehicle operation. The driver is and must remain at all times responsible for the vehicle speed and for safe brake operation.

Only use cruise control if the road, traffic and weather conditions make it advisable to travel at a steady speed.

- The use of cruise control can be dangerous on winding roads or in heavy traffic because conditions do not allow safe driving at a steady speed.
- The use of cruise control can be dangerous on slippery roads. Rapid changes in tire traction can result in wheel spin and loss of control.
- Deactivate cruise control when driving in fog.

The “Resume” function should only be operated if the driver is fully aware of the previously set speed and wishes to resume this particular preset speed.

Driving systems

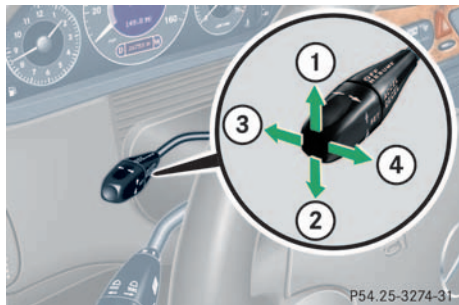

- 1 Set current or higher speed
- 2 Set current or lower speed
- 3 Cancel cruise control
- 4 Resume at previously set speed

Saving current speed

- ▶ Accelerate or decelerate to the desired speed.
- ▶ Briefly lift **1** or depress **2** the cruise control lever.

The current speed is set.

- ▶ Remove your foot from the accelerator pedal.

Cruise control is activated.



On uphill or downhill grades, cruise control may not be able to maintain the set speed. Once the grade eases, the set speed will be resumed.

Canceling cruise control

There are several ways to cancel cruise control:

- ▶ Step on the brake pedal.
- or
- ▶ Briefly push the cruise control lever to position **3**.

Cruise control will be canceled. The last speed set will be stored for later use.



Moving gear selector lever to position **N** while driving also cancels cruise control. However, the gear selector lever should not be moved to position **N** while driving except to coast when the vehicle is in danger of skidding (e.g. on icy roads).



The last stored speed is canceled when you turn off the engine.

Setting stored speed ("Resume" function)

Warning!



The speed stored in memory should only be set again if prevailing road conditions permit. Possible acceleration or deceleration differences arising from returning to the pre-set speed could cause an accident and/or serious injury to you and others.

- ▶ Briefly push the cruise control lever to position **4**.

The cruise control will resume the last previously set speed.

- ▶ Remove your foot from the accelerator pedal.

Setting a higher speed

- ▶ Lift the cruise control lever to position **1** and hold it up until the desired speed is reached.
- ▶ Release the cruise control lever.
The new speed is set.



Depressing the accelerator pedal does not deactivate cruise control. After brief acceleration (e.g. for passing), cruise control will resume the last speed set.

Setting a lower speed

- ▶ Depress the cruise control lever to position **2** and hold it down until the desired speed is reached.
- ▶ Release the cruise control lever.
The new speed is set.



When you use the cruise control lever to decelerate, the transmission will automatically downshift if the engine's braking power does not brake the vehicle sufficiently.

Fine adjustment in 1 mph (1 km/h) increments

Faster

- ▶ Briefly tip the cruise control lever in the direction of arrow **1**.

Slower

- ▶ Briefly tip the cruise control lever in the direction of arrow **2**.

Driving systems

Distronic*

When activated, the DISTRONIC adaptive cruise control system increases the driving convenience afforded by the cruise control during travel on expressways and other major roads.

- If the DISTRONIC distance sensor detects a slower moving vehicle directly ahead, your vehicle speed will be reduced so that you follow that vehicle at a preset distance.
- If there is no vehicle directly ahead of you, DISTRONIC will function in the same way as cruise control (▷ page 193).

Warning!



DISTRONIC adaptive cruise control is no substitute for active driving involvement. It does not react to stationary objects, nor recognize or predict the curvature and lane layout or the movement of vehicles ahead. DISTRONIC can only apply a maximum of 20% of the vehicle's braking power.

It is the driver's responsibility at all times to be attentive to traffic and road conditions and to provide the steering, braking and other driving inputs necessary to retain control of the vehicle.

Warning!



DISTRONIC is a convenience system. Its speed adjustment reduction capability is intended to make cruise control more effective and usable when traffic speeds vary. However, it is not intended to, nor does it, replace the need for extreme care. The responsibility for the vehicle speed and the distance to the vehicle ahead, including most importantly brake operation to assure safe stopping distance, always rests with the driver.

DISTRONIC cannot take street and traffic conditions into account.

Warning!



DISTRONIC requires familiarity with its operational characteristics. We strongly recommend that you review the following information carefully before operating the system.



For operation in the USA only: This device complies with Part 15 of the FCC Rules. Operation is subject to the following two conditions:

- This device may not cause harmful interference, and
- this device must accept any interference received, including interference that may cause undesired operation.

Any unauthorized modification to this device could void the user's authority to operate the equipment.

Warning!

Distronic cannot take street and traffic conditions into account. Only use DISTRONIC if the road, traffic and weather conditions make it advisable to travel at a steady speed.

Warning!

Use of DISTRONIC can be dangerous on slippery roads. Rapid changes in tire traction can result in wheel spin and loss of control.

DISTRONIC does not act upon adverse sight distance conditions. Do not use DISTRONIC during conditions of fog and heavy rain, snow or sleet.

Warning!

Close attention to road and traffic conditions is imperative at all times, regardless of whether or not DISTRONIC is activated.

Use of DISTRONIC can be dangerous on winding roads or in heavy traffic because conditions do not allow safe driving at a steady speed.

DISTRONIC will not react to stationary objects in the roadway (e.g. a stopped vehicle in a traffic jam or a disabled vehicle). DISTRONIC will also not respond to oncoming vehicles.

Switch off DISTRONIC:

- when changing from the left to the right lane if vehicles are moving more slowly in the left lane
- when entering a turn lane or highway off ramp
- in complex driving situations, such as in highway construction zones

In these situations, DISTRONIC will continue to maintain the set speed unless deactivated.

DISTRONIC is designed and intended only to maintain a set speed and keep a set distance from moving objects in front of it.

Warning!

The “Resume” function should only be operated if the driver is fully aware of the previously set speed and wishes to resume this particular preset speed.

Driving systems

Distronic displays in the speedometer dial



1 Set speed

If Disticronic is activated, one or two segments light up around the set speed.



The vehicle speed displayed on the speedometer can briefly vary from the speed setting on the Disticronic system.



1 Segments

If Disticronic detects a vehicle directly ahead, the segments from the speed of the vehicle ahead to set speed light up.

If Disticronic calculates that there is a danger of collision

- the DTR warning lamp  in the instrument cluster lights up red
- an intermittent warning sounds
- ▶ Immediately brake the vehicle to avoid a collision.

Under no circumstances should the driver await the intermittent warning sound before braking. See warning note on the next page.

The intermittent warning sound ceases and the red DTR warning lamp  goes out when the necessary distance to the vehicle ahead is again established.

Warning!

An intermittent warning sounds and the DTR warning lamp in the instrument cluster is illuminated if the Distronic system calculates that the distance to the vehicle ahead and your vehicle's current speed indicate that Distronic will not be capable of slowing the vehicle sufficiently to maintain the preset following distance, which creates a danger of a collision.

Immediately brake the vehicle to increase the distance to the vehicle in front of you. The warning sound is intended as a final caution that you have not interceded with your own braking inputs to avoid a potentially dangerous situation. Do not wait for the operation of the warning signal to intercede with your own braking, as that will result in potentially dangerous emergency braking which will not always result in an impact being avoided.

Tailgating increases the risk of an accident.

Warning!

Distronic brakes your vehicle with a maximum of 6.5 ft/s^2 (2 m/s^2). This corresponds to about 20% of the maximum deceleration ability of your vehicle.



Distronic brakes the vehicle in an effort to restore the preset distance or to maintain the speed. The brake pedal is automatically applied as this happens which results in the brake pedal moving.

Keep driver's foot area clear at all times, including the area under the brake pedal. Objects stored in this area may impair pedal movement which could interfere with the braking ability of the Distronic system.

Do not place your foot under the brake pedal – your foot could become caught.

Distronic menu in the control system

In the Distronic menu you can read the current settings for Distronic. What appears in the display depends on whether Distronic and the distance warning function are turned on or off.

- Press button  or  repeatedly until you see one of the following displays.

Driving systems

Distronic deactivated

If Distronic is deactivated you can see the standard display of Distronic in the multifunction display.

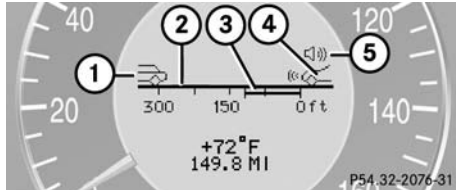

- 1 Vehicle ahead, if detected
- 2 Actual distance to vehicle ahead
- 3 Should-be distance to vehicle ahead
- 4 Your vehicle
- 5 Symbol for activated distance warning function

Distronic activated

If you turn Distronic on, you will see the set speed in the multifunction display for about five seconds. If Distronic is activated, you can see the following display in the multifunction display.

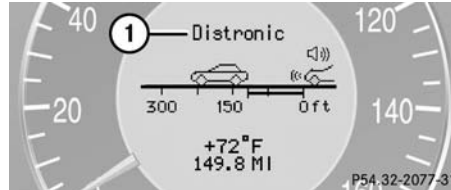

- 1 Distronic activated

Cruise control lever

The Distronic system is operated by means of the cruise control lever.

The cruise control lever is the uppermost lever found on the left-hand side of the steering column.

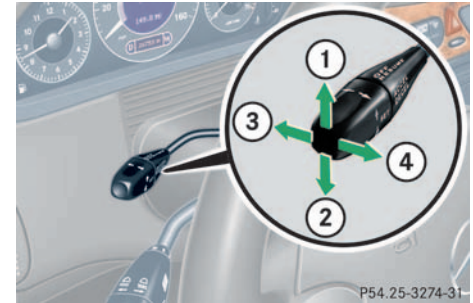

- 1 Set current or higher speed
- 2 Set current or lower speed
- 3 Deactivate Distronic
- 4 Resume at previously set speed

Activating Distronic

You can activate Distronic if

- you are driving between 25 mph (Canada:40 km/h) and 110 mph (Canada:180 km/h)
- the ESP is activated (▷ page 76)

If Distronic has not been activated after pressing the cruise control lever you will see the message --- in the multifunction display.

In the following cases you cannot activate Distronic:

- up to two minutes after starting the engine.
- when you brake.
- if you have set the parking brake.
- if the gear selector lever is in position **P**, **R** or **N**.
- if ESP is switched off.

Setting the current speed

- ▶ Accelerate or decelerate to the desired speed.
- ▶ Briefly lift or depress the cruise control lever.

Distronic is activated and the current speed is set.

- ▶ Remove your foot from the accelerator pedal.



If you do not take your foot off of the accelerator completely, the following message will appear in the multifunction display:
Distronic override. The distance to a slower moving vehicle in front of you will not be set. Your vehicle speed will then be determined only by the accelerator pedal position.

Setting a higher speed

- ▶ Briefly tip the cruise control lever in the direction of arrow 1 (▷ page 200) to increase vehicle speed in increments of 5 mph (Canada: 10 km/h).

The new speed is set.

The stored speed is displayed in the multifunction display for approximately five seconds (▷ page 200), and one or two segments around the stored speed light up on the speedometer (▷ page 198).



Depressing the accelerator pedal does not deactivate Distronic. After brief acceleration (e.g. for passing), the cruise control will resume the last speed set.

Driving systems

Setting a lower speed

- ▶ Briefly tip the cruise control lever in the direction of arrow **2** (▷ page 200) to decrease vehicle speed in increments of 5 mph (Canada: 10 km/h).

The new speed is set.

The stored speed is displayed in the multifunction display for approximately five seconds (▷ page 200), and one or two segments around the stored speed light up on the speedometer (▷ page 198).



When you use the cruise control lever to decelerate, the transmission will automatically downshift if the rate of deceleration is too low.

Fine adjustment in 1 mph (Canada: 1 km/h) increments

Faster

- ▶ Briefly tip the cruise control lever in the direction of arrow **4** (▷ page 200).

Resetting stored speeds

Warning!



The speed stored in memory should only be set again if prevailing road conditions permit. Possible acceleration or deceleration differences arising from returning to the pre-set speed could cause an accident and/or serious injury to you and others.

- ▶ Briefly tip the cruise control lever in the direction of arrow **4** (▷ page 200).
Distronic is set to the last stored speed.
- ▶ Remove your foot from the accelerator pedal.

Deactivating Distronic

There are several ways to deactivate the Distronic system:

- ▶ Briefly tip the cruise control lever in the direction of arrow **3** (▷ page 200).

or

- ▶ Step on the brake pedal.

Distronic will be deactivated. The last speed set will be stored into memory.



The following message will appear in the multifunction display for approximately five seconds: *Distronic off*.

The last stored speed is deleted when you turn off the engine.

Distronic deactivates automatically when

- you set the parking brake
- you drive slower than 25 mph (Canada: 40 km/h)
- the ESP is active (▷ page 76) or you deactivate the ESP
- you move the transmission selector lever into position **N**.

A signal will sound. The *Distronic off* message appears in the multifunction display for approximately five seconds.

Warning!



Distronic switches off and releases the brakes when the vehicle decelerates below the minimum speed of approx. 25 mph (40 km/h) by operation of the system. At that time the driver must apply the brakes in order to reduce vehicle speed further or bring it to a stop.

Setting the following distance in Distronic

You can set the specified following distance for Distronic by varying the time setting between 1.0 and 2.0 seconds. Using this time setting and the current speed of your vehicle, Distronic calculates and sets the required following distance to the vehicle ahead. The set distance will be shown in the multifunction display field.

The thumbwheel for making the time setting is located on the lower section of the center console.

Warning!



It is up to the driver to exercise discretion to select the appropriate setting given road conditions, traffic, driver's preferred driving style and applicable laws and driving recommendations for safe following distance.

Driving systems



- 1 Distance warning function on/off switch
- 2 Control lamp
- 3 Thumbwheel for setting distance

Increasing distance

Increasing the distance setting tells Distronic to maintain a greater following distance to the vehicle ahead.

- Turn thumbwheel **3** towards .

Decreasing distance

Decreasing the distance setting tells Distronic to maintain a shorter following distance to the vehicle ahead.

- Turn thumbwheel **3** towards .

Distance warning function

When Distronic is deactivated, this function will continue to warn you when recognizing a stationary obstacle or a slower vehicle moving in the vehicle's path and the danger of a collision exists:

- The distance warning lamp  in the instrument cluster lights up
- An intermittent warning sounds.

If these warnings are issued, you must brake manually to maintain a safe distance and avoid a collision with the vehicle ahead.

When pressing the brake pedal, the warning sound stops. The warning sound also stops when the distance to the vehicle

ahead is sufficient again without applying the brake pedal. In this case the distance warning lamp also extinguishes.

Warning!



If the DTR warning lamp  in the instrument cluster lights up while driving and/or an intermittent warning sounds, immediate attention on the part of the driver is required.

As required by the traffic situation, apply the brakes and navigate around a possible obstacle. However, do not drive by relying on the distance warning function, as this will result in an emergency braking application. Especially depending on road surface conditions and driver reaction, this will not always enable you to avoid a collision.



Complex driving situations are not always fully recognized by Distronic. This could result in wrong or missing distance warnings.

Activating

- ▶ Press switch **1**.

Indicator lamp **2** on the switch lights up. A loudspeaker symbol appears in the multifunction display (▷ page 200).

Deactivating

- ▶ Press switch **1**.

Indicator lamp **2** on the switch goes out. No loudspeaker symbol appears in the multifunction display.

Driving with Distronic

This section describes a number of driving situations where special precaution is required on the part of the driver. Be prepared to brake in such situations. This will deactivate the Distronic system.

Warning!

Distronic works to maintain the speed selected by the driver unless a moving obstacle proceeding directly ahead of it in the same travel direction is detected (e.g. following another vehicle ahead of you at a distance set by Distronic). This means that:

- Your vehicle can pass another vehicle after you change lanes.
- While in a sharp turn or if the vehicle in front is in a sharp turn, Distronic could lose sight of a vehicle traveling in front of it. Your vehicle could then accelerate to the previously selected speed.

Distronic regulates only the distance between your vehicle and those directly ahead of it, but does not register stationary objects in the road, e.g.:

- a stopped vehicle in a traffic jam
- a disabled vehicle
- an oncoming vehicle

The driver must always be on the alert, observe all traffic and intercede as required by steering or braking the vehicle.

Warning!

Distronic should not be used in snowy or icy road conditions.

Driving systems

The most likely cause for a malfunctioning system is a dirty sensor (located behind the hood grill), especially at times of snow and ice or heavy rain. In such a case, Distronic will switch off, and the message *Distronic Unavailable!* see *oper. manual* appears in the multi-function display.

For cleaning and care of the Distronic sensor, see “Cleaning the Distronic* system sensor cover” (▷ page 271).



If the message *Distronic Unavailable!* see *oper. manual* disappears during driving and the last speed stored flashes for approximately five seconds, the dirt (e.g. slush) has dissolved; Distronic works again.

Turns and bends

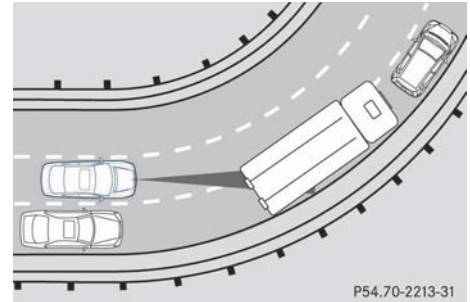

In turns or bends, Distronic may not detect a moving vehicle in front, or it may detect one too soon. This may cause your vehicle to brake late or unexpectedly.

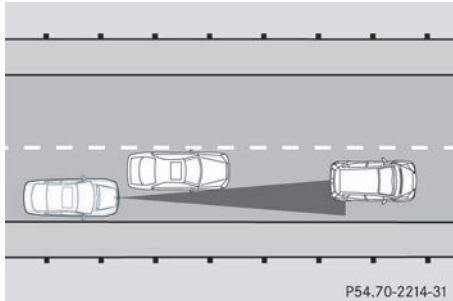
Offset driving

A vehicle traveling in your lane but offset from your direct line of travel may not be detected by DISTRONIC. There will be insufficient distance to the vehicle ahead.

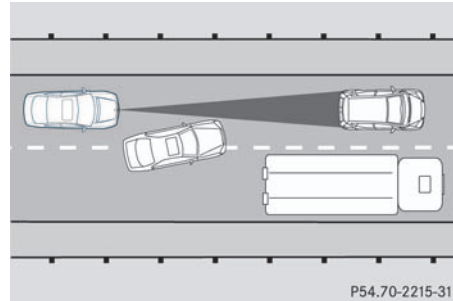
Lane changing

DISTRONIC has not yet detected the vehicle changing lanes. There will be insufficient distance to the lane changing vehicle.

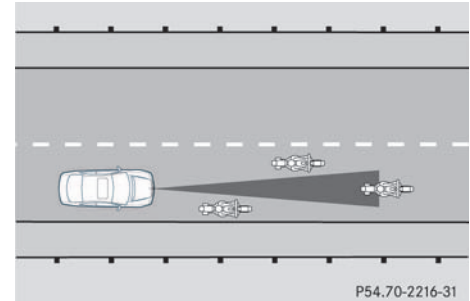
Narrow vehicles

Because of its narrow profile, the vehicle traveling near the edge of the roadway has not yet been detected by DISTRONIC. There will be insufficient distance to the vehicle ahead.

PARKTRONIC system*

Warning!



Parktronic is a supplemental system. It is not intended to, nor does it replace, the need for extreme care. The responsibility during parking and other critical maneuvers always rests with the driver.

Special attention must be paid to objects with smooth surfaces or low silhouettes (e.g. trailer couplings, painted posts or street curbs). Such objects may not be detected by the system and can damage the vehicle.

The operational function of the Parktronic can be affected by dirty sensors, especially at times of snow and ice, see “Cleaning the Parktronic* system sensors” (▷ page 272).

Interference caused by other ultrasonic signals (e.g. working jackhammers or the air brakes of trucks) can cause the system to send erratic indications, and should be taken into consideration.

Warning!



Make sure that no persons or animals are in the area in which you are maneuvering. You could otherwise injure them.

The Parktronic system is an electronic aid designed to assist the driver during parking maneuvers. It visually and audibly indicates the relative distance between the vehicle and an obstacle.

The Parktronic system is automatically activated when you switch on the ignition and release the parking brake. The Parktronic system deactivates at speeds over 11 mph (18 km/h). At lower speeds the Parktronic system turns on again.

The Parktronic system monitors the surroundings of your vehicle with six sensors in the front bumper and four sensors in the rear bumper.

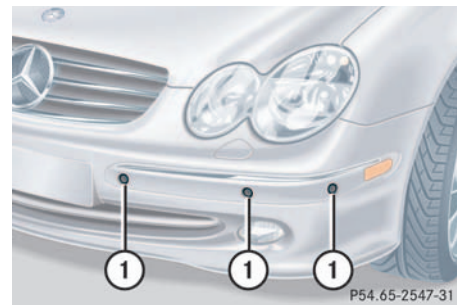

1 Sensors in the front bumper

Range of the sensors

To function properly, the sensors must be free of dirt, ice, snow and slush. Clean the sensors regularly, being careful not to scratch or damage the sensors.

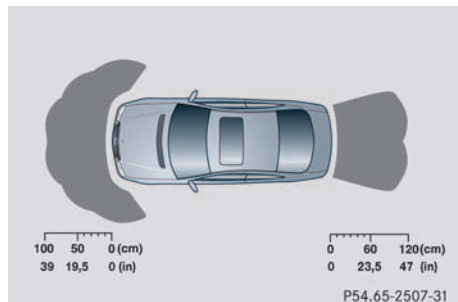
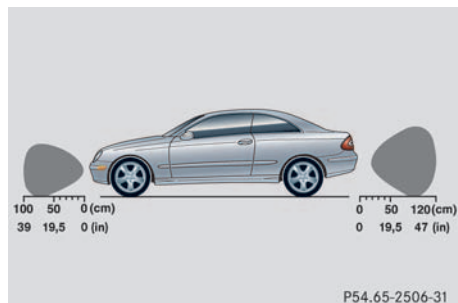

Front sensors

Center	approx. 40 in (100 cm)
Corners	approx. 23 in (60 cm)

Rear sensors

Center	approx. 48 in (120 cm)
Corners	approx. 32 in (80 cm)



During parking maneuvers, pay special attention to objects located above or below the height of the sensors (e.g. planters or trailer hitches). The Parktronic system will not detect such objects at close range and damage to your vehicle or the object may result.

Ultrasonic signals from outside sources (e.g. truck air brakes or jackhammers) may impair the operation of the Parktronic system.

Minimum distance

Center	approx. 8 in (20 cm)
Corners	approx. 6 in (15 cm)

If the system encounters an obstacle in this range, all the warning lamps light up and you hear a warning signal. If the obstacle is closer than the minimum distance, the actual distance may no longer be indicated by the system.

Driving systems

Warning indicators

Visual signals indicate to the driver the relative distance between the sensors and an obstacle. The warning indicator for the front area is located above the center air vents in the dashboard. The warning indicator for the rear area is integrated in the rear trim.

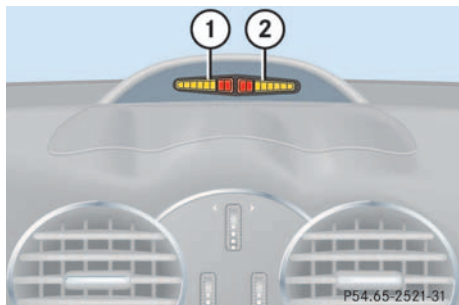

Front area warning indicator

- 1 Left side of the vehicle
- 2 Right side of the vehicle

Each warning indicator is divided into six yellow and two red segments for either side of the vehicle. The Parktronic system is ready when the border around the indicator is illuminated.

The position of the gear selector lever determines which warning indicators will be activated.

Selector lever position	Warning indicator
D	Front area activated
R or N	Rear area activated
P	Neither activated

As your vehicle approaches an object, one or more segments will light up, depending on the distance. When the eighth segment lights up, you have reached the minimum distance.

- **Front area:** An intermittent acoustic warning will sound as the seventh segment lights up and a constant acoustic warning lasting a maximum of three seconds will sound for the eighth segment.
- **Rear area:** An intermittent acoustic warning will sound when the first segment lights up. This signal quickens with each additional segment lit. When the eighth segment illuminates, the acoustic warning becomes a constant signal. The signal is canceled when the selector lever is placed in position **D** or **P**.

Switching the Parktronic system on/off

You can switch off the Parktronic system manually.

The Parktronic switch is located in the lower section of the center console.

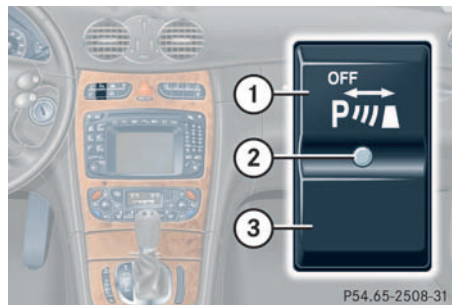

- 1 Parktronic off
- 2 Indicator lamp
- 3 Parktronic on

Switching off the Parktronic system

- ▶ Press upper half **1** of the switch.
Indicator lamp **2** comes on.

Switching on the Parktronic system

- ▶ Press lower half **3** of the switch.
Indicator lamp **2** goes out.

Loading

Loading

Roof rack

Warning!



Only use those roof racks approved by Mercedes-Benz for your vehicle model to avoid damage to the vehicle. Follow manufacturer's installation instructions.

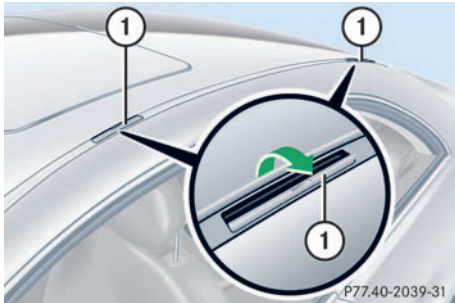

1 Trim

Preparing roof rack installation

- ▶ Open trim 1 at the trim strips in the roof.
- ▶ Secure the roof rack according to manufacturer's instructions for installation.



Be sure to stack a load on the roof rack so that the vehicle cannot be damaged while driving.

Make sure that:

- you can fully raise the sliding/pop-up roof*
- you can fully open the trunk

Ski sack*



Unfolding and loading

- ▶ Fold armrest down (arrow).
- ▶ Swing cover 1 down.



- ▶ Open hook and loop strap **2**.
- ▶ Pull ski sack into passenger compartment and unfold.

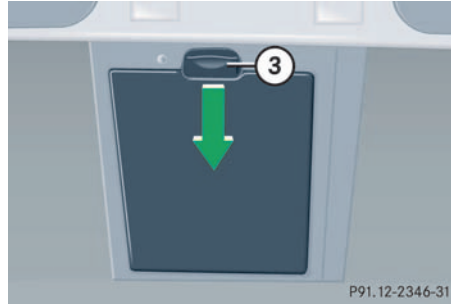

- ▶ Open flap in the trunk by pulling handle **3**.



- ▶ From trunk, slide skis into ski sack.

Warning!



The ski sack is designed for up to four pairs of skis. Do not load the ski sack with other objects.

Always fasten the ski sack securely. In an accident, an unfastened ski sack can cause injury to vehicle occupants.

Loading

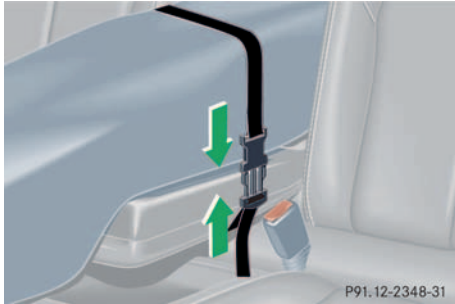

- ▶ Wrap strap around ski sack and armrest.
- ▶ Close clasp (arrows) and pull strap tight to immobilize skis.

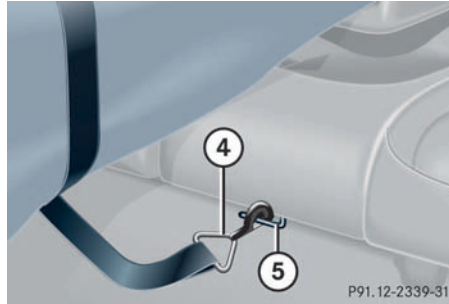

- ▶ Connect snap hook **4** of front strap to eye **5** located on center tunnel in front of rear seat bench.

Unloading and folding

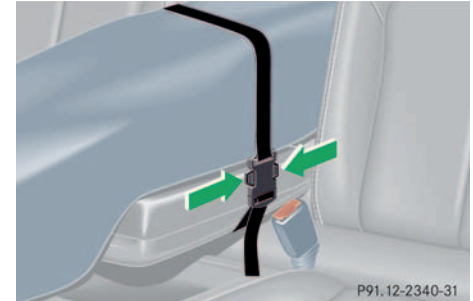

- ▶ Loosen strap, open clasp by pressing tabs together (arrows).
- ▶ Unload skis.
- ▶ Close flap in trunk.
- ▶ Disconnect snap hook **4** from eye **5**.
- ▶ Fold and flatten ski sack lengthwise and place folded ski sack inside recess of backrest.



- ▶ Close ski sack compartment cover.

Removal of ski sack

For removal of the ski sack we recommend that you contact an authorized Mercedes-Benz Center.

Warning!



Never drive vehicle with trunk open while the ski sack is removed. Deadly carbon monoxide (CO) gases may enter vehicle interior, resulting in unconsciousness and death.



To prevent unauthorized persons from access to the trunk, always close the cover.

Split rear bench seat

To expand the trunk, you can fold down the left and right rear seat backrests.

The two sections can be folded down separately to enlarge the trunk.

Warning!



When expanding the luggage compartment, always fold the seat cushions fully forward.

Unless you are transporting cargo, the backrests must remain properly locked in the upright position.

In an accident, during hard braking or sudden maneuvers, loose items will be thrown around inside the vehicle, and cause injury to vehicle occupants unless the items are securely fastened in the vehicle.

Always use the cargo tie down rings (▷ page 218).

Loading

Folding the backrest forward

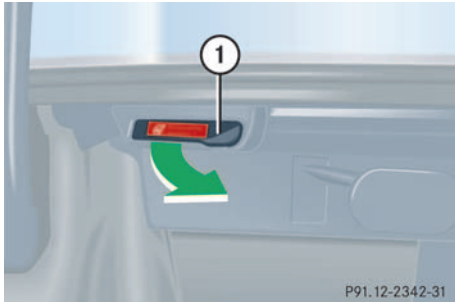

1 Release handle for the backrest in the trunk

- ▶ Fold back head restraint and push it down fully (▷ page 98).
- ▶ Open the trunk.
- ▶ Pull release handle 1.
The backrests are released.



- ▶ Pull release handle 2.
The seat cushions are released.



- ▶ Fold seat cushion 3 forward.
- ▶ Fold rear seat backrests 4 forward.

Folding the backrest rearward

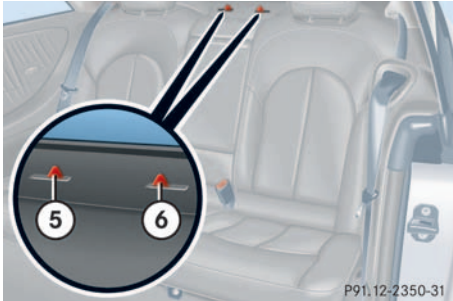

- 5 Left locking indicator
- 6 Right locking indicator

- ▶ Fold backrest **4** rearward until it engages.
- ▶ Fold seat cushions **3** rearward until they lock into position.

If a backrest is not locked into position, a red indicator **5** or **6** will be visible.

- ▶ Check for secure locking by pushing and pulling on the backrest.

Warning!



If a red indicator is visible with the backrest up, then the backrest is not properly locked into position.

Always lock backrest in its upright position when rear seat bench is occupied, or the extended trunk compartment is not in use. Check for secure locking by pushing and pulling on the backrest.

In an accident, during hard braking or sudden maneuvers, loose items will be thrown around inside the vehicle, and cause injury to vehicle occupants unless the items are securely fastened in the vehicle.

To help avoid personal injury during a collision or sudden maneuver, exercise care when transporting cargo.

Loading instructions

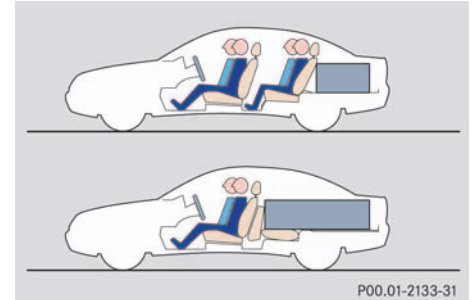

The total load weight including vehicle occupants and luggage/cargo should not exceed the vehicle capacity weight indicated on the certification tag which can be found on the left door pillar.

Loading

The handling characteristics of a fully loaded vehicle depend greatly on the load distribution. It is therefore recommended to load the vehicle according to the illustrations shown, with the heaviest items being placed towards the front of the vehicle.

Always place items being carried against front or rear seat backrests, and fasten them as securely as possible.

The heaviest portion of the cargo should always be kept as low as possible since it influences the handling characteristics of the vehicle.

Warning!



Always fasten items being carried as securely as possible.

In an accident, during hard braking or sudden maneuvers, loose items will be thrown around inside the vehicle and can cause injury to vehicle occupants unless the items are securely fastened in the vehicle.

To help avoid personal injury during a collision or sudden maneuver, exercise care when transporting cargo. Put luggage or cargo in the trunk if possible. Do not pile luggage or cargo higher than the seat backs. Do not place anything on the shelf below the rear windows.

Never drive vehicle with trunk open. Deadly carbon monoxide (CO) gases may enter vehicle interior resulting in unconsciousness and death.

Cargo tie-down rings

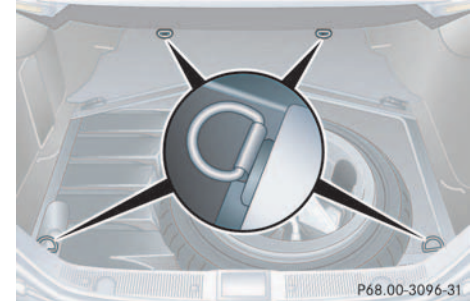

Four rings (arrows) are located in the cargo compartment.

- Carefully secure cargo by applying even load on all rings with rope of sufficient strength to hold down the cargo.

Always follow loading instructions (► page 217).

Useful features

Interior storage spaces

Warning!



To help avoid personal injury during a collision or sudden maneuver, exercise care when stowing objects in the vehicle. Put luggage or cargo in the cargo compartment if possible. Do not pile luggage or cargo higher than the seat backs.

Luggage nets cannot secure hard or heavy objects.

Keep compartment lids closed. This will help to prevent stored objects from being thrown about and injuring vehicle occupants during an accident.

Glove box

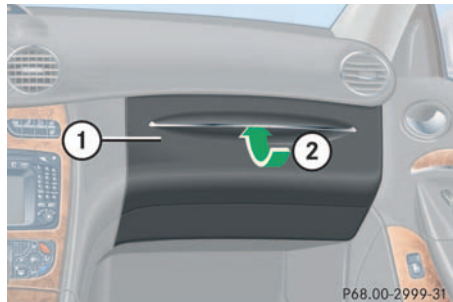

- 1 Glove box
- 2 Glove box lid release

Opening the glove box

- ▶ Pull lid release **2**.
- The glove box lid opens downward.

Closing the glove box

- ▶ Push lid up to close.



The glove box lid contains a compartment for eyeglasses.

Close the compartment for glasses first before closing the glove box.

Audio system/COMAND* with CD changer*: The CD changer is located in the glove box.

Useful features

Cup holder in the dashboard

Warning!



When not in use, keep the cup holder closed. Place only containers that fit into the cup holder to prevent spills. Use lids on open containers and do not fill containers to a height where the contents, especially hot liquids, could spill during vehicle maneuvers.

Opening cup holder

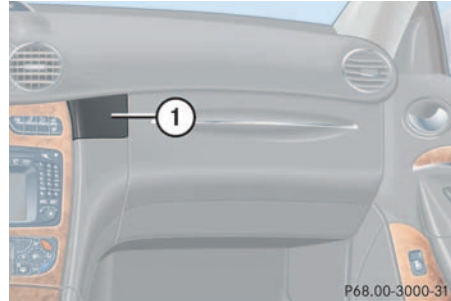

- ▶ Push cover 1.

The cup holder opens automatically.

Closing cup holder

- ▶ Push the cup holder back until it engages.

Cup holder in rear seat armrest

Warning!



When not in use, keep the cup holder closed. Place only containers that fit into the cup holder to prevent spills. Use lids on open containers and do not fill containers to a height where the contents, especially hot liquids, could spill during vehicle maneuvers.



Opening cup holder

- ▶ Push front of sliding compartment **1**.
The cup holder slides out.

Closing cup holder

- ▶ Push sliding compartment **1** back until it engages.

Armrest storage space

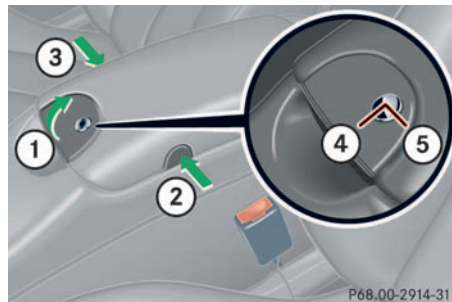

Opening compartment in armrest

- ▶ Lift armrest by handle **1**.

Closing

- ▶ Lower armrest until it locks into place.



Do not store any items between the telephone holder and the cover for the blower. Otherwise these items could be damaged when the holder is closed. Use the space in the front door pocket for stowing.

Opening telephone compartment

- ▶ Lift armrest by pushing button **2** or **3**.

Closing telephone compartment

- ▶ Lower armrest until it locks into place.

Locking compartment

- ▶ Remove the mechanical key from the SmartKey (> page 310).
- ▶ Turn the compartment lock to position **5**.

Unlocking compartment

- ▶ Turn the compartment lock to position **4**.
- ▶ Insert the mechanical key in the SmartKey.

Useful features

Changing inclination of armrest

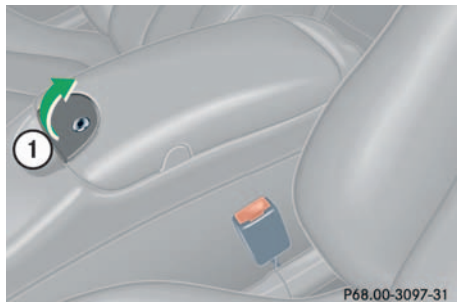

- ▶ Pull up on armrest.

Lowering armrest

- ▶ Pull handle 1 to lower armrest.

Storage bags

Storage bags are located on the rear side of the front seats.

Warning!



Do not place heavy or fragile objects, or objects having sharp edges, in the storage bags.

In an accident, during hard braking or sudden maneuvers, they could be thrown around inside the vehicle, and cause injury to vehicle occupants.

Parcel net in front passenger footwell

A small convenience parcel net is located in the front passenger footwell. It is for small and light items, such as road maps, mail, etc.

Warning!



Do not place heavy or fragile objects, or objects having sharp edges, in the parcel net.

In an accident, during hard braking or sudden maneuvers, they could be thrown around inside the vehicle, and cause injury to vehicle occupants.

Ashtrays

Center console ashtray

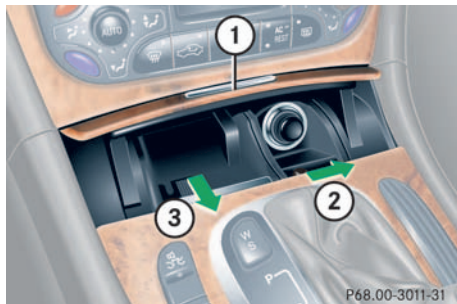

Opening ashtray

- ▶ Briefly touch cover plate **1**.
The ashtray opens automatically.

Removing ashtray insert

Warning!



Remove front ashtray only with vehicle standing still. Set the parking brake to secure vehicle from movement. Move gear selector lever to position **N**. With gear selector lever in position **N**, turn off the engine.

- ▶ Secure vehicle from movement by setting the parking brake. Move the selector lever to position **N**.

Now you have more room to take out the insert.

- ▶ Push sliding button **2** to the right.
The ashtray is disengaged and slides a short way in direction of arrow **3**.
- ▶ Remove insert from ashtray frame.

Reinstalling the ashtray insert

- ▶ Install insert by pushing back into frame until it engages again.

Useful features

Rear seat ashtray

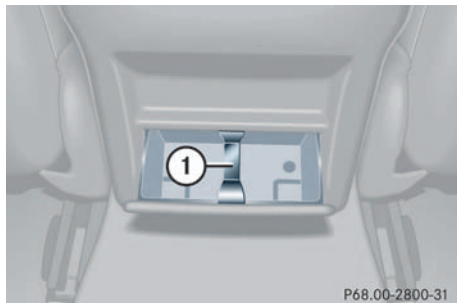

Opening ashtray

- ▶ Pull at top of cover to open ashtray.

Removing ashtray insert

- ▶ Press latch **1** to disengage ashtray insert and remove it.

Reinstalling the ashtray insert

- ▶ Install ashtray insert.
- ▶ Close the ashtray.

Cigarette lighter



- 1** Cover
- 2** Cigarette lighter

- ▶ Turn key in the starter switch to position **1** or **2**.
- ▶ Briefly touch cover plate **1**.
- ▶ Push in cigarette lighter **2**.

The lighter will pop out automatically when hot.

Warning!



Never touch the heating element or sides of the lighter; they are extremely hot. Hold the knob only.

When leaving the vehicle always remove the key from the starter switch, take the Smart-Key with KEYLESS-GO* (if so equipped) with you and lock the vehicle. Do not leave children unattended in the vehicle, or with access to an unlocked vehicle. Unsupervised use of vehicle equipment may cause an accident and/or serious personal injury.



The lighter socket can be used to accommodate electrical accessories up to a maximum 85 W.

Floormats*

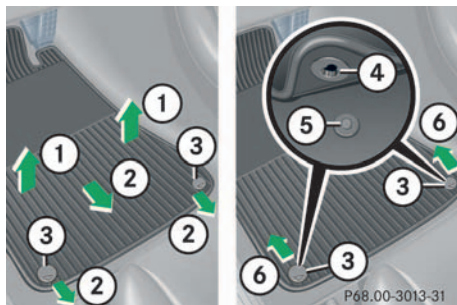

Removing

- ▶ Raise the floormat slightly in the middle **1** and push the floormat towards the rear **2**.

Mountings **3** are unlatched.

Installing

- ▶ Lay down the floormat.
- ▶ Press the floormat with eyelets **4** onto retainer pins **5**.
- ▶ Pull the floormat forward **6** until it snaps into place.

Warning!



Whenever you are using floormats, make sure that there is enough clearance and that the floormats are securely fastened.

Floormats should always be securely fastened using eyelets **4** and retainer pins **5**.

Before driving off, check that the floormats are securely in place and adjust them if necessary. A loose floormat could slip and hinder proper functioning of the pedals.

Useful features

Telephone*

Warning!



Never operate radio transmitters equipped with a built-in or attached antenna (i.e. without being connected to an external antenna) from inside the vehicle while the engine is running. Doing so could lead to a malfunction of the vehicle's electronic system, possibly resulting in an accident and/or serious personal injury.

Radio transmitters, such as a portable telephone or a citizens band unit, should only be used inside the vehicle if they are connected to an antenna that is installed on the outside of the vehicle.

The external antenna must be approved by Mercedes-Benz. Please contact an authorized Mercedes-Benz Center for information on the installation of an approved external antenna. Refer to the radio transmitter operation instructions regarding use of an external antenna.

Warning!





Please do not forget that your primary responsibility is to drive the vehicle. A driver's attention to the road must always be his /her primary focus when driving. For your safety and the safety of others, we recommend that you pull over to a safe location and stop before placing or taking a telephone call.

If you choose to use the telephone¹ while driving, please use the hands-free device and only use the telephone when road, traffic and weather conditions permit. Some jurisdictions prohibit the driver from using a cellular telephone while driving a vehicle.

Only operate the COMAND* (Cockpit Management and Data System)¹ if road, traffic and weather conditions permit.

¹ Observe all legal requirements.

Bear in mind that at a speed of just 30 mph (approximately 50 km/h), your vehicle is covering a distance of approx. 44 feet (approximately 13.5 m) every second.

You can take and place telephone calls using the  and  buttons on the steering wheel. To carry out other telephone functions, use the control system (▷ page 138).

See separate operating manual for instructions on how to use the telephone.

Tele Aid



The initial activation of the Tele Aid system may only be performed by completing the subscriber agreement and placing an acquaintance call using the SOS button. Failure to complete either of these steps will result in a system that is not activated. If the system is not activated, the indicator lamp in the SOS button stays on after turning key in starter switch to position **2** or pressing KEYLESS-GO* start/stop button (if so equipped) twice to position **2** (▷ page 33). The message *Tele Aid not activated* will be shown in the multifunction display for approx. 10 seconds.

If you have any questions regarding activation, please call the Response Center at 1-800-756-9018 (in the USA) or 1-888-923-8367 (in Canada).

The Tele Aid system

(**Telematic Alarm Identification on Demand**)

The Tele Aid system consists of three types of response:

- automatic and manual emergency
- roadside assistance and
- information

The Tele Aid system is operational providing that the vehicle's battery is charged, properly connected, not damaged and cellular and GPS coverage is available.

The speaker volume of a Tele Aid call can be adjusted when using the volume control on the multifunction steering wheel. To raise, press button and to lower, press button .

- ▶ To activate, press the SOS button, the Roadside Assistance button or the Information button , depending on the type of response required.



The SOS button is located above the inside rear view mirror.



The Roadside Assistance button and the Information button are located below the center armrest cover.

Shortly after the completion of your Acquaintance Call, you will receive a user ID and password via first call mail. By visiting www.mbusa.com and selecting "Tele Aid" (USA only), you will have access to account information, remote door unlock and more.



The Tele Aid system utilizes the cellular network for communication and the GPS (Global Positioning System) satellites for vehicle location. If either of these signals is unavailable, the Tele Aid system may not function and if this occurs, assistance must be summoned by other means.

System self-check

Initially, after turning the key in starter switch to position **2**, malfunctions are detected and indicated (the indicator lamps in the SOS button, the Roadside Assistance button  and the Information button  stay on longer than 10 seconds or do not come on). The message **Tele Aid defective! Visit workshop!** appears for approx. 10 seconds in the multifunction display.

Warning!



If the indicator lamps in the SOS button, in the Roadside Assistance button and/or in the Information button do not come on during the system self-check or if any of these indicators remain illuminated constantly in red and/or the message **Tele Aid defective! Visit workshop!** is displayed in the multifunction display after the system self-check, a malfunction in the system has been detected.

If a malfunction is indicated as outlined above, the system may not operate as expected. Have the system checked at the nearest Mercedes-Benz Center as soon as possible.

Emergency calls

An emergency call is initiated automatically:

- following an accident in which the emergency tensioning devices (ETDs) or airbags deploy
- if the anti-theft alarm or the tow-away alarm stays on for more than 20 seconds, see “Anti-theft systems” (▷ page 79) and see “Tow-away alarm” (▷ page 81).

An emergency call can also be initiated manually by opening the cover next to the inside rear view mirror labeled SOS, then briefly pressing the button located under the cover. See below for instructions on initiating an emergency call manually.

Once the emergency call is in progress, the indicator lamp in the SOS button will begin to flash. The message **Emergency call - Connecting call** appears in the multifunction display.

When the connection is established, the message `Emergency call - Call connected` appears in the multifunction display. All information relevant to the emergency, such as the location of the vehicle (determined by the GPS satellite location system), vehicle model, identification number and color are generated.

A voice connection between the Response Center and the occupants of the vehicle will be established automatically soon after the emergency call has been initiated. When a voice connection is established the audio system mutes and the message `Tele Aid - Emergency call active` appears in the multifunction display. The Response Center will attempt to determine more precisely the nature of the accident provided they can speak to an occupant of the vehicle.

The Tele Aid system is available if:

- it has been activated and is operational. Activation requires a subscription for monitoring services, connection and cellular air time
- the relevant cellular phone network and GPS signals are available and pass the information on to the response center



Location of the vehicle on a map is only possible if the vehicle is able to receive signals from the GPS satellite network and pass the information on to the response center.

Warning!



If the indicator lamp in the SOS button is illuminated continuously and there was no voice connection to the Response Center established, then the Tele Aid system could not initiate an emergency call (e.g. the relevant cellular phone network is not available). The message `Emergency call - Call failed` appears in the multifunction display for approx. 10 seconds.

Should this occur, assistance must be summoned by other means.

Useful features

Initiating an emergency call manually



1 Cover

2 SOS button

- ▶ Briefly press on cover **1**.

The cover will open.

- ▶ Press SOS button **2** briefly.

The indicator lamp in SOS button **2** will flash until the emergency call is concluded.

- ▶ Wait for a voice connection to the Response Center.
- ▶ Close cover **1** after the emergency call is concluded.

Warning!



If you feel at any way in jeopardy when in the vehicle (e.g. smoke or fire in the vehicle, vehicle in a dangerous road location), please do not wait for voice contact after you have pressed the emergency button. Carefully leave the vehicle and move to a safe location. The Response Center will automatically contact local emergency officials with the vehicle's approximate location if they receive an automatic SOS signal and cannot make voice contact with the vehicle occupants.

Roadside Assistance button 

Located below the center armrest cover is the Roadside Assistance button .

- ▶ Press and hold the button (for longer than 2 seconds).

A call to a Mercedes-Benz Roadside Assistance dispatcher will be initiated. The button will flash while the call is in progress. The message *Roadside Assistance - Connecting call* will appear in the multifunction display.

When the connection is established, the message *Roadside Assistance - Call connected* appears in the multifunction display. The Tele Aid system will transmit data generating the vehicle identification number, model, color and location (subject to availability of cellular and GPS signals).

A voice connection between the Roadside Assistance dispatcher and the occupants of the vehicle will be established. When a voice connection is established the audio system mutes and the message *Tele Aid - Roadside Assistance call active* appears in the multifunction display.



- ▶ Describe the nature of the need for assistance.

The Mercedes-Benz Roadside assistance dispatcher will either dispatch a qualified Mercedes-Benz technician or arrange to tow your vehicle to the nearest Mercedes-Benz Center. For services such as labor and/or towing, charges may apply. Refer to the Roadside Assistance manual for more information.

These programs are only available in the USA:

- Sign and Drive services: Services such as jump start, a few gallons of fuel or the replacement of a flat tire with the vehicle spare tire are obtainable.
- Remote Vehicle Diagnostics: This function permits the Mercedes-Benz Roadside Assistance dispatcher to download malfunction codes and actual vehicle data.



The indicator lamp in the Roadside Assistance button  remains illuminated in red for approx. 10 seconds during the system self-check after turning the key in the starter switch to position 2 (together with the SOS button and the Information button .

See system self-check (▷ page 228) when the indicator lamp does not light up in red or stays on longer than approximately 10 seconds.

Useful features

If the indicator lamp in the Roadside Assistance button  is illuminated continuously and there was no voice connection to the Response Center established, then the Tele Aid system could not initiate a Roadside Assistance call (e.g. the relevant cellular phone network is not available). The message *Roadside Assistance - Call failed* appears in the multifunction display.

Roadside Assistance calls can be terminated using the  button on the multifunction steering wheel.

Information button

Located below the center armrest cover is the Information button .

- ▶ Press and hold the button (for longer than 2 seconds).

A call to the Customer Assistance Center will be initiated. The button will flash while the call is in progress. The message *Info - Connecting call* will appear in the multifunction display.



When the connection is established, the message *Info - Call connected* appears in the multifunction display. The Tele Aid system will transmit data generating the vehicle identification number, model, color and location (subject to availability of cellular and GPS signals).

A voice connection between the Customer Assistance Center representative and the occupants of the vehicle will be established. When a voice connection is established the audio system mutes and the message *Tele Aid - Info call active* appears in the multifunction display. Infor-

mation regarding the operation of your vehicle, the nearest Mercedes-Benz Center or Mercedes-Benz USA products and services is available to you.

For more details concerning the Tele Aid system, please visit www.mbusa.com and use your ID and password (sent to you separately) to learn more (USA only).



The indicator lamp in the Information button  remains illuminated in red for approx. 10 seconds during the system self-check after turning key in the starter switch to position **2** (together with the SOS button and the Roadside Assistance button .

See System self-check (▷ page 228) when the indicator lamp does not light up in red or stays on longer than approximately 10 seconds.

If the indicator lamp in the Information button  is illuminated continuously and there was no voice connection to

the Response Center established, then the Tele Aid system could not initiate an Information call (e.g. the relevant cellular phone network is not available). The message

Info - Call failed appears in the multifunction display.

Information calls can be terminated using the  button on the multifunction steering wheel.



If the indicator lamps do not start flashing after pressing one of the buttons or remain illuminated (in red) at any time, the Tele Aid system has detected a fault or the service is not currently active, and may not initiate a call. Visit your Mercedes-Benz Center and have the system checked or contact the Response Center at 1-800-756-9018 (in the USA) or 1-888-923-8367 (in Canada) as soon as possible.

Upgrade signals

The Tele Aid system processes calls using the following priority.

- Automatic emergency – First priority
- Manual emergency – Second priority
- Roadside assistance – Third priority
- Information – Fourth priority

Should a higher priority call be initiated while you are connected, an upgrade (alternating) tone will be heard, and the appropriate indicator lamp will flash. If certain information such as vehicle identification number or customer information is not available, the operator may need to retransmit.

During this time you will hear a beep and voice contact will be interrupted. Voice contact will resume once the retransmission is completed. Once a call is concluded, a beep will be heard and the appropriate indicator lamp will stop flashing. The COMAND* system operation will resume.



If the indicator lamp continues to flash or the system does not reset, contact the Response Center at 1-800-756-9018 (in the USA) or 1-888-923-8367 (in Canada), or Mercedes-Benz Customer Assistance at 1-800-FOR-MERCEdes (1-800-367-6372) in the USA or Customer Service at 1-800-387-0100 in Canada.



The indicator lamp in the respective button flashes until the call is concluded. Calls can only be terminated by a Response Center or Customer Assistance Center representative except Roadside Assistance and Information calls, which can also be terminated by pressing button  on the multifunction steering wheel.

Useful features



When a Tele Aid call has been initiated, the audio system or the COMAND* system audio is muted and the selected mode (radio, tape or CD) pauses. The optional cellular phone (if installed) switches off. If you must use this phone, the vehicle must be parked. Disconnect the coiled cord and place the call. The COMAND* navigation system (if engaged) will continue to run. The display in the instrument cluster is available for use and spoken commands are only available by pressing the RPT button on the COMAND* unit. A pop-up window will appear in the COMAND* display to indicate that a Tele Aid call is in progress.

Remote door unlock

In case you have locked your vehicle unintentionally (e.g. key inside vehicle), and the reserve key is not handy:

- ▶ Contact the Mercedes-Benz Response Center at 1-800-756-9018 (in the USA) or 1-888-923-8367 (in Canada).

You will be asked to provide your password which you provided when you completed the subscriber agreement.

- ▶ Then return to your vehicle and pull the trunk recessed handle for a minimum of 20 seconds until the SOS button is flashing.

The message *Emergency call - Call connected* appears in the multifunction display.

As an alternative, you may unlock the vehicle via Internet using the ID and password sent to you shortly after the completion of your Acquaintance Call.

The Response Center will then unlock your vehicle with the remote door unlocking feature.



The remote door unlock feature is available if the relevant cellular phone network is available.

The SOS button will flash and the message *Emergency call - Call connected* will appear in the multifunction display to indicate receipt of the door unlock command.

Once the vehicle is unlocked, a Response Center specialist will attempt to establish voice contact with the vehicle occupants.

If the trunk recessed handle was pulled for more than 20 seconds before door unlock authorization was received by the Response Center, you must wait 15 minutes before pulling the trunk recessed handle again.

Stolen vehicle tracking services

In the event your vehicle was stolen:

- ▶ Report the incident to the police.
The police will issue a numbered incident report.
- ▶ Pass this number on to the Mercedes-Benz Response Center along with your password issued to you when you subscribed to the service.

The Response Center will then attempt to covertly contact the vehicle's Tele Aid system. Once the vehicle is located, the Response Center will contact the local law enforcement and you. The vehicle's location will only be provided to law enforcement.

Garage door opener

The built-in remote control is capable of operating up to three separately controlled objects.

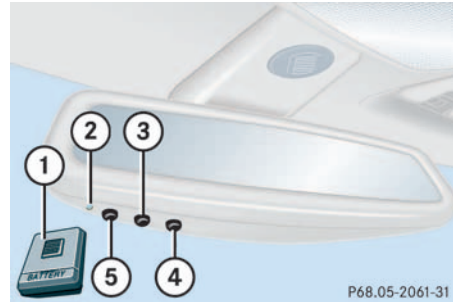

- 1** Hand-held remote control transmitter
- 2** Indicator lamp
- 3, 4, 5** Signal transmitter key

Warning!



When programming a garage door opener, the door moves up or down.

When programming or operating the remote control, make sure there is no possibility of anyone being injured by the moving door.



Certain types of garage door openers are incompatible with the integrated opener. If you should experience difficulties with programming the transmitter, contact your authorized Mercedes-Benz Center, or call Mercedes-Benz Customer Assistance Center (in the USA only) at 1-800-FOR-MERCEdes, or Customer Service (in Canada) at 1-800-387-0100.

Useful features



For operation in the USA only: This device complies with Part 15 of the FCC Rules. Operation is subject to the following two conditions:

- (1) This device may not cause harmful interference, and
- (2) this device must accept any interference received, including interference that may cause undesired operation.

Any unauthorized modification to this device could void the user's authority to operate the equipment.

Programming or reprogramming the integrated remote control

- ▶ Turn key in the starter switch to position **1** or **2**.
- ▶ Hold the end of the hand-held transmitter of the device you wish to train approximately 2 to 5 inches (5 cm to 12 cm) away from the surface of the integrated remote control located on the inside rear view mirror, keeping the indicator lamp in view.
- ▶ Using both hands, simultaneously push the hand-held transmitter button and the desired integrated remote control button. Do not release the buttons until completing next step.

- ▶ The indicator lamp on the integrated remote control will flash, first slowly and then rapidly. The rapid flashing lamp indicates successful programming of the new frequency signal.
- ▶ When the indicator lamp flashes rapidly, release both buttons.
- ▶ To program the remaining two buttons, repeat the above steps.



If, after several attempts, you do not successfully program the integrated remote control device to learn the signal of the hand-held transmitter, the garage door opener could be equipped with the "rolling code feature".

Rolling code programming

To train a garage door opener (or other rolling code devices) with the rolling code feature, follow these instructions after completing the “Programming” portion of this text. (A second person may make the following training procedures quicker and easier.)

- ▶ Locate training button on the garage door opener motor head unit.

Exact location and color of the button may vary by garage door opener brand. If there is difficulty locating the transmitting button, refer to garage door opener operator’s manual.

- ▶ Press “training” button on the garage door opener motor head unit.

The “training light” is activated.

You have 30 seconds time to initiate the following step.

- ▶ Firmly press and release the programmed integrated remote control transmit button.
- ▶ Press and release same button a second time to complete the training process.

Some garage door openers may require you to do this procedure a third time to complete the training.

- ▶ Confirm the garage door operation by pressing the programmed button on the integrated remote control transmitter.

Canadian programming

During programming, your hand-held transmitter may automatically stop transmitting.

- ▶ Continue to press and hold the integrated remote control transmitter button (refer to steps two through four in the “Programming” portion) while you press and re-press (“cycle”) your hand-held transmitter every two seconds until the frequency signal has been learned.

Upon successful training, the indicator lamp will flash slowly and then rapidly after several seconds.

Useful features

Operating the remote control

- ▶ Turn key in starter switch to position **1** or **2**.
- ▶ Select and press the appropriate button to activate the remote controlled device.

The integrated remote control transmitter continues to send the signal as long as the button is pressed – up to 20 seconds.

Erasing the remote control memory

- ▶ Turn key in starter switch to position **1** or **2**.
- ▶ Simultaneously hold down the left and right side buttons for approximately 20 seconds, or until the indicator lamp blinks rapidly.

The codes of all three channels are erased.



If you sell your vehicle, erase the codes of all three channels.

The first 1000 miles (1500 km)

Driving instructions

At the gas station

Engine compartment

Tires and wheels

Winter driving

Maintenance

Vehicle care



The first 1000 miles (1500 km)

In the “Operation” section you will find detailed information on operating, maintaining and caring for your vehicle.

The first 1000 miles (1500 km)

The more cautiously you treat your vehicle during the break-in period, the more satisfied you will be with its performance later on.

- Drive your vehicle during the first 1000 miles (1500 km) at varying but moderate vehicle and engine speeds.
- During this period, avoid heavy loads (full throttle driving) and excessive engine speeds (no more than $\frac{2}{3}$ of maximum rpm in each gear).
- Avoid accelerating by kickdown.
- Do not attempt to slow the vehicle down by shifting to a lower gear using the selector lever.
- Select positions **3**, **2** or **1** only when driving at moderate speeds (for hill driving).



Additional instructions for AMG vehicles:

- During the first 1000 miles (1500 km) do not exceed a speed of 85 mph (140 km/h).
- During this period, avoid engine speeds above 4500 rpm in each gear.

All of the above instructions, as may apply to your vehicle type, also apply when driving the first 1000 miles (1500 km) after the engine or the rear differential has been replaced.

After 1000 miles (1500 km), you may gradually increase vehicle and engine speeds to the permissible maximum.



Always obey applicable speed limits.

Driving instructions

Drive sensibly – save fuel

Fuel consumption, to a great extent, depends on driving habits and operating conditions.

To save fuel you should:

- Keep tires at the recommended inflation pressures.
- Remove unnecessary loads.
- Remove roof rack when not in use.
- Allow engine to warm up under low load use.
- Avoid frequent acceleration and deceleration.
- Have all maintenance work performed at regular intervals by an authorized Mercedes-Benz Center.

Fuel consumption is also increased by driving in cold weather, in stop-and-go traffic, on short trips and in hilly country.

Drinking and driving

Warning!



Drinking and driving and/or taking drugs and driving are very dangerous combinations. Even a small amount of alcohol or drugs can affect your reflexes, perceptions and judgement.

The possibility of a serious or even fatal accident is sharply increased when you drink or take drugs and drive.

Please don't drink or take drugs and drive or allow anyone to drive after drinking or taking drugs.

Pedals

Warning!



Keep driver's foot area clear at all times. Objects stored in this area may impair pedal movement.

Power assistance

Warning!



With the engine off, there is no power assistance for the steering systems. In this case, it is important to keep in mind that a considerably higher degree of effort is necessary to steer the vehicle.

Brakes

Warning!



After driving in heavy rain for some time without applying the brakes or through water deep enough to wet brake components, the first braking action may be somewhat reduced and increased pedal pressure may be necessary to obtain expected braking effect. Maintain a safe distance from vehicles in front.

Resting your foot on the brake pedal will cause excessive and premature wear of the brake pads.

It can also result in the brakes overheating, thereby significantly reducing their effectiveness. It may not be possible to stop the vehicle in sufficient time to avoid an accident.

To help prevent brake disk corrosion after driving on wet road surfaces (particularly salted roads), it is advisable to brake the vehicle with considerable force prior to parking. The heat generated serves to dry the brakes.

If your brake system is normally only subjected to moderate loads, you should occasionally test the effectiveness of the brakes by applying above-normal braking pressure at higher speeds. This will also enhance the grip of the brake pads.



Be very careful not to endanger other road users when you apply the brakes.

Refer to the description of the Brake Assist System (BAS) (▷ page 76).

If the parking brake is released and the brake warning lamp in the instrument cluster stays on, the brake fluid level in the reservoir is too low.

Brake pad wear or a leak in the system may be the reason for low brake fluid in the reservoir.

Have the brake system inspected at an authorized Mercedes-Benz Center immediately.

All checks and service work on the brake system should be carried out by an authorized Mercedes-Benz Center.

Only install brake pads and brake fluid recommended by Mercedes-Benz.

Warning!

If other than recommended brake pads are installed, or other than recommended brake fluid is used, the braking properties of the vehicle can be degraded to an extent that safe braking is substantially impaired. This could result in an accident.



When driving down long and steep grades, relieve the load on the brakes by shifting into a lower gear to use the engine's braking power. This helps prevent overheating of the brakes and reduces brake pad wear.

After hard braking, it is advisable to drive on for some time, rather than immediately parking, so that the air stream can cool down the brakes faster.

Driving off

Apply the brakes to test them briefly after driving off. Perform this procedure only when the road is clear of other traffic.

Warm up the engine gradually. Do not place full load on the engine until the operating temperature has been reached.

When starting off on a slippery surface, do not allow one drive wheel to spin for an extended period. Doing so may cause serious damage to the drive train which is not covered by the Mercedes-Benz Limited Warranty.



Simultaneously depressing the accelerator pedal and applying the brake reduces engine performance and causes premature brake wear and drivetrain wear.

Parking

Set the parking brake whenever parking or leaving the vehicle. In addition, move selector lever to position **P**.

In addition, when parking on hills, turn front wheels towards the road curb.

Warning!

Do not park this vehicle in areas where combustible materials such as grass, hay or leaves can come into contact with the hot exhaust system, as these materials could be ignited and cause a vehicle fire.

Driving instructions

Warning!



To reduce the risk of personal injury as a result of inadvertent vehicle movement, before turning off the engine and leaving the vehicle always:

- Keep right foot firmly on brake pedal.
- Firmly depress parking brake pedal.
- Move the selector lever to position **P**.
- Slowly release brake pedal.
- When parked on an incline, turn front wheels towards the road curb.
- Turn the key to starter switch position **0** and remove, or press KEYLESS-GO* start/stop button (vehicles with KEYLESS-GO*).
- Take the key or the SmartKey with KEYLESS-GO* (if so equipped) with you and lock vehicle when leaving.

Tires

Warning!



If you feel a sudden significant vibration or ride disturbance, or you suspect that possible damage to your vehicle has occurred, you should turn on the hazard warning flashers, carefully slow down, and drive with caution to an area which is a safe distance from the road.

Inspect the tires and the vehicle underbody for possible damage. If the vehicle or tires appear unsafe, have it towed to the nearest Mercedes-Benz Center or tire dealer for repairs.

Tread wear indicators (TWI) are required by law. These indicators are located in six places on the tread circumference and become visible at a tread depth of approximately $\frac{1}{16}$ in (1.5 mm), at which point the tire is considered worn and should be replaced.

The tread wear indicator appears as a solid band across the tread.

Warning!



Do not allow your tires to wear down too far. As tread depth approaches $\frac{1}{16}$ in (1.5 mm), the adhesion properties on a wet road are sharply reduced.

Depending upon the weather and/or road surface (conditions), the tire traction varies widely.

Specified tire pressures must be maintained. This applies particularly if the tires are subjected to extreme operating conditions (e.g. high speeds, heavy loads, high ambient temperatures).

Warning!

Do not drive with a flat tire. A flat tire affects the ability to steer or brake the vehicle. You may lose control of the vehicle. Continued driving with a flat tire or driving at high speed with a flat tire will cause excessive heat build-up and possibly a fire.

Hydroplaning

Depending on the depth of the water layer on the road, hydroplaning may occur, even at low speeds and with new tires. Reduce vehicle speed, avoid track grooves in the road and apply brakes cautiously in the rain.

Tire traction

The safe speed on a wet, snow covered or icy road is always lower than on a dry road. You should pay particular attention to the condition of the road whenever the outside temperatures are close to the freezing point.

Warning!

If ice has formed on the road, tire traction will be substantially reduced. Under such weather conditions, drive, steer and brake with extreme caution.

Mercedes-Benz recommends M+S rated radial-ply tires for the winter season for all four wheels to insure normal balanced handling characteristics. On packed snow, they can reduce your stopping distance compared to summer tires. Stopping distance, however, is still considerably greater than when the road is not covered with snow or ice. Exercise appropriate caution.

Tire speed rating

Regardless of the tire rating, local speed limits should be obeyed. Use prudent driving speeds appropriate to prevailing conditions.

Warning!

Even when permitted by law, never operate a vehicle at speeds greater than the maximum speed rating of the tires.

Exceeding the maximum speed for which tires are rated can lead to sudden tire failure, causing loss of vehicle control and possibly resulting in an accident and/or personal injury and possible death, for you and for others.

CLK 320

Your vehicle is factory equipped with “H”-rated tires, which have a speed rating of 130 mph (210 km/h).

Driving instructions

An electronic speed limiter prevents your vehicle from exceeding a speed of 130 mph (210 km/h).

CLK 500/ CLK 320 with Sport Package*

Your vehicle is factory equipped with “W”-rated tires, which have a speed rating of 168 mph (270 km/h).

An electronic speed limiter prevents your vehicle from exceeding a speed of 155 mph (250 km/h).

CLK 55 AMG

Your vehicle is factory equipped with “Y”-rated tires, which have a speed rating of 188 mph (300 km/h).

An electronic speed limiter prevents your vehicle from exceeding a speed of 155 mph (250 km/h).

Information on tire speed rating for winter tires, see “Winter tires” (▷ page 264).

Winter driving instructions

The most important rule for slippery or icy roads is to drive sensibly and to avoid abrupt acceleration, braking and steering maneuvers. Do not use the cruise control system under such conditions.

When the vehicle is in danger of skidding, move selector lever to position **N**. Try to keep the vehicle under control by corrective steering action.



Information on driving with snow chains (▷ page 265).

Warning!



On slippery road surfaces, never downshift in order to obtain braking action. This could result in drive wheel slip and reduced vehicle control. Your vehicle’s ABS will not prevent this type of control loss.

Road salts and chemicals can adversely affect braking efficiency. Increased pedal force may become necessary to produce the normal braking effect.

We therefore recommend depressing the brake pedal periodically when traveling at length on salt-strewn roads.

This can bring road salt impaired braking efficiency back to normal. Be very careful that you carry out these braking maneuvers without endangering any other road users.

If the vehicle is parked after being driven on salt-treated roads, the braking efficiency should be tested as soon as possible after driving is resumed while observing the safety rules in the previous paragraph.

Warning!

If the vehicle becomes stuck in snow, make sure that snow is kept clear of the exhaust pipe and from around the vehicle with the engine running. Otherwise, deadly carbon monoxide (CO) gases may enter vehicle interior resulting in unconsciousness and death.

To assure sufficient fresh air ventilation, open a window slightly on the side of the vehicle not facing the wind.

Warning!

The outside temperature indicator is not designed to serve as an ice-warning device and is therefore unsuitable for that purpose. Indicated temperatures just above the freezing point do not guarantee that the road surface is free of ice.

For more information on winter driving (▷ page 264).

Standing water

Do not drive through flooded areas or water of unknown depth.

If you must drive through standing water, drive slowly to prevent water from entering the passenger compartment or the engine compartment. Water in these areas could cause damage to electrical components or wiring of the engine or transmission, or could result in water being ingested by the engine through the air intake, causing severe internal engine damage. Any such damage is not covered by the Mercedes-Benz Limited Warranty.

Passenger compartment**Warning!**

Always fasten items being carried as securely as possible.

In an accident, during hard braking or sudden maneuvers, loose items will be thrown around inside the vehicle, and cause injury to vehicle occupants unless the items are securely fastened in the vehicle.

The trunk is the preferred place to carry objects.

Driving abroad

Abroad, there is a widely-spread Mercedes-Benz service network at your disposal. If you plan to drive into areas which are not listed in the index of your Mercedes-Benz Center directory, you should request pertinent information from your authorized Mercedes-Benz Center.

Driving instructions

Control and operation of radio transmitters

COMAND*, radio and telephone*

Warning!



Please do not forget that your primary responsibility is to drive the vehicle safely. Only operate the COMAND (Cockpit Management and Data System), radio or telephone¹ if road, traffic and weather conditions permit.

Bear in mind that at a speed of just 30 mph (approximately 50 km/h), your vehicle is covering a distance of approximately 44 feet (approximately 13.5 m) every second.

¹ Observe all legal requirements.

Telephones and two-way radios

Warning!



Never operate radio transmitters equipped with a built-in or attached antenna (i.e. without being connected to an external antenna) from inside the vehicle while the engine is running. Doing so could lead to a malfunction of the vehicle's electronic system, possibly resulting in an accident and/or serious personal injury.

Radio transmitters, such as a portable telephone or a citizens band unit should only be used inside the vehicle if they are connected to an antenna that is installed on the outside of the vehicle.

Refer to the radio transmitter operation instructions regarding use of an external antenna.

Catalytic converter

Your Mercedes-Benz is equipped with monolithic type catalytic converters, an important element in conjunction with the oxygen sensors to achieve substantial control of the pollutants in the exhaust emissions. Keep your vehicle in proper operating condition by following our recommended maintenance instructions as outlined in your Service Booklet.



To prevent damage to the catalytic converters, only use premium unleaded gasoline in this vehicle.

Any noticeable irregularities in engine operation should be dealt with promptly. Otherwise, excessive unburned fuel may reach the catalytic converter, causing it to overheat and start a fire.

Warning!

As with any vehicle, do not idle, park or operate this vehicle in areas where combustible materials such as grass, hay, or leaves can come into contact with the hot exhaust system, as these materials could be ignited and cause a vehicle fire.

Emission control

Certain systems of the engine serve to keep the toxic components of the exhaust gases within permissible limits required by law.

These systems, of course, will function properly only when maintained strictly according to factory specifications. Any adjustments to the engine should therefore be carried out only by qualified Mercedes-Benz Center authorized technicians.

Engine adjustments should not be altered in any way. Moreover, the specified service jobs must be carried out regularly according to Mercedes-Benz servicing requirements. For details refer to the Service Booklet.

Warning!

Inhalation of exhaust gas is hazardous to your health. All exhaust gas contains carbon monoxide, and inhaling it can cause unconsciousness and lead to death.

Do not run the engine in confined areas (such as a garage) which are not properly ventilated. If you think that exhaust gas fumes are entering the vehicle while driving, have the cause determined and corrected immediately. If you must drive under these conditions, drive with at least one window fully open at all times.

Driving instructions

Coolant temperature

During severe operating conditions and stop-and-go city traffic, the coolant temperature may rise close to approx. 248°F (120°C).

The engine should not be operated with the coolant temperature over 248°F (120°C). Doing so may cause serious engine damage which is not covered by the Mercedes-Benz Limited Warranty.

Warning!



- Driving when your engine is badly overheated can cause some fluids, which may have leaked into the engine compartment, to catch fire. You could be seriously burned.
- Steam from an overheated engine can cause serious burns and can occur just by opening the engine hood. Stay away from the engine if you see or hear steam coming from it.

Turn off the engine, get out of the vehicle and do not stand near the vehicle until it cools down.

At the gas station

Warning!



Gasoline is highly flammable and poisonous. It burns violently and can cause serious injury. Whenever you are around gasoline, avoid inhaling fumes and skin contact, extinguish all smoking materials. Never allow sparks, flame or smoking materials near gasoline!

The fuel filler flap is located on the right-hand side of the vehicle towards the rear. Locking/unlocking the vehicle with the remote control or the SmartKey with KEYLESS-GO* automatically locks/unlocks the fuel filler flap.

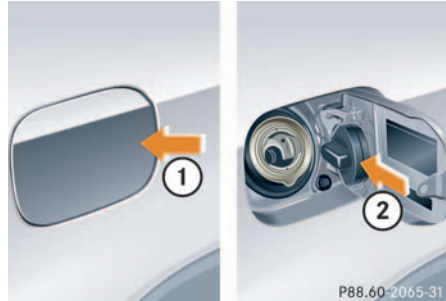

- ▶ Remove the key from the starter switch.
- ▶ Open the fuel filler flap by pushing at the point indicated by the arrow.
The fuel filler flap springs open.
- ▶ Turn the fuel cap to the left and hold on to it until possible pressure is released.
- ▶ Take off the cap and set it in the recess on the fuel filler flap.
To prevent fuel vapors from escaping into open air, fully insert filler nozzle unit.
- ▶ Only fill your tank until the filler nozzle unit cuts out – do not top up or overfill.

Warning!



Overfilling of the fuel tank may create pressure in the system which could cause a gas discharge. This could cause the gas to spray back out when removing the fuel pump nozzle, which could cause personal injury.

- ▶ Replace the fuel cap by turning it to the right.
You will hear when the fuel cap is tightened.
- ▶ Close the fuel filler flap.



Only use premium unleaded gasoline with a minimum Posted Octane Rating of 91 (average of 96 RON / 86 MON). Information on gasoline quality can normally be found on the fuel pump.

More information on gasoline can be found in the Factory Approved Service Products pamphlet.

At the gas station



Leaving the engine running and the fuel cap open can cause the **CHECK ENGINE** lamp to illuminate.

More information can be found in the “Practical hints” section (▷ page 280).

Check regularly and before a long trip

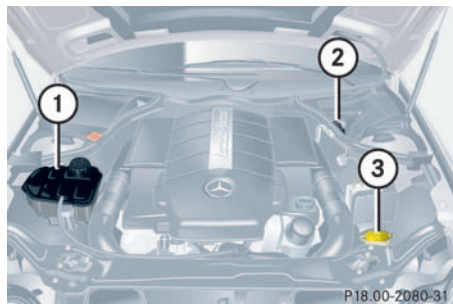

1 Coolant level

More information on coolant can be found in the “Operation” section on (▷ page 256).

2 Brake fluid (fuse box cover removed)

More information on brake fluid can be found in the “Technical data” section on (▷ page 353).

3 Windshield washer and headlamp cleaning system

More information on refilling the reservoir can be found in the “Operation” section on (▷ page 259).

Engine oil level

More information on engine oil can be found in the “Operation” section on (▷ page 254).

Vehicle lighting

Check function and cleanliness. More information on replacing light bulbs can be found in the “Practical hints” section on (▷ page 316).

Tire inflation pressure

More information on tire inflate pressure can be found in the “Operation” section on (▷ page 262).

Opening hood see (▷ page 253).

Removing fuse box cover see (▷ page 337).

Exterior lamp switch see (▷ page 105)

Engine compartment

Engine compartment

Hood

Warning!



Do not pull the release lever while the vehicle is in motion. Otherwise the hood could be forced open by passing air flow.

Opening

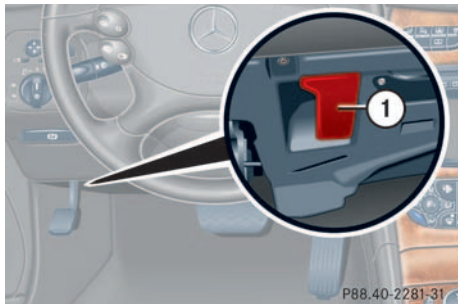

1 Hood lock release

- ▶ Pull lever **1** downwards.
The hood is unlocked.



To avoid damage to the windshield wipers or hood, never open the hood if the wiper arms are folded forward away from the windshield.



2 Lever for opening the hood

- ▶ Push lever **2** on the hood upwards.
- ▶ Pull up on the hood and then release it.

The hood will be automatically held open at shoulder height by gas-filled struts.

Warning!



To help prevent personal injury, stay clear of moving parts when the hood is open and the engine is running. Make sure the hood is properly closed before driving. When closing the hood, use extreme caution not to catch hands or fingers.

The radiator fan may continue to run for approximately 30 seconds or may even restart after the engine has been turned off. Stay clear of fan blades.

Engine compartment

Warning!



If you see flames or smoke coming from the engine compartment, or if the coolant temperature gauge indicates that the engine is overheated, do not open the hood. Move away from the vehicle and do not open the hood until the engine has cooled. If necessary, call the fire department.

Warning!



The engine is equipped with a transistorized ignition system. Because of the high voltage it is dangerous to touch any components (ignition coils, spark plug sockets, diagnostic socket) of the ignition system

- with the engine running
- while starting the engine
- if ignition is “on” and the engine is turned manually

Closing

Warning!



Be careful that you do not close the hood on anyone.

- ▶ Let the hood drop from a height of approximately 1 ft (30 cm).

The hood will lock audibly.

- ▶ Check to make sure that the hood is fully closed.

If you can raise the hood at a point above the headlamps, then it is not properly closed. Open it again and let it drop with somewhat greater force.

Engine oil

The amount of oil your engine needs will depend on a number of factors, including driving style. Higher oil consumption can occur when

- the vehicle is new
- the vehicle is driven frequently at higher engine speeds

Engine oil consumption checks should only be made after the vehicle break-in period.

Checking engine oil level



When checking the oil level the vehicle must

- be parked on level ground
- be at normal operating temperature
- have been stationary for at least five minutes with the engine turned off

You can check the engine oil level on the multifunction display.

- ▶ Turn the key in the starter switch to position **2**.

The standard display (▶ page 114) should appear in the multifunction display.

- ▶ Press button  or  on the steering wheel until the following message is seen in the multifunction display:

Engine oil level Measuring now!
Measurement correct only if veh.
level



One of the following messages will subsequently appear in the indicator:

- Engine oil level ok
 - Add 1.0 qt. to reach max. oil level!
(Canada: 1.0 liter)
 - Add 1.5 qts. to reach max. oil level!
(Canada: 1.5 liters)
 - Add 2.0 qts. to reach max. oil level!
(Canada: 2.0 liters)
- ▶ If necessary, add engine oil.

Adding engine oil

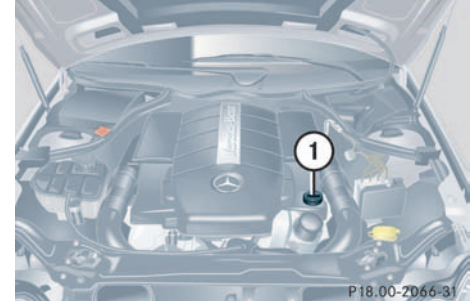

1 Filler neck

- ▶ Unscrew the cap from filler neck **1**. Be careful not to overfill with oil.

Be careful not to spill any oil when adding. Avoid environmental damage caused by oil entering the ground or water.

Engine compartment



Excessive oil must be siphoned or drained off. It could cause damage to the engine and catalytic converter not covered by the Mercedes-Benz Limited Warranty.

- ▶ Screw the cap back on the filler neck.

Other display messages

If there is excessive engine oil with the engine at normal operating temperature, the following message will appear:

Engine oil level Reduce oil level!

- ▶ Have excess oil siphoned.

If the key is not turned to position **2** in the starter switch:

Turn on ignition to see engine oil level!

- ▶ Switch on the ignition.

If you see the message:

Observe waiting time



- ▶ Wait five minutes before repeating check procedure.

If you see the message:

Engine oil level Not when engine on!

- ▶ Turn off the engine. If engine is at normal operating temperature, wait five minutes before checking oil. If the engine is not yet at normal operating temperature, you must wait 30 minutes before checking oil.



If you want to interrupt the checking procedure, press the  or  button on the multifunction steering wheel.

See “Practical hints” (▶ page 294) if the engine oil level indicator lights up in the display while the engine is running.

More information on engine oil can be found in the “Technical data” (▶ page 353).

Transmission fluid level

The transmission fluid level does not need to be checked. If you notice transmission fluid loss or gear shifting malfunctions, have an authorized Mercedes-Benz Center check the automatic transmission.

Coolant

The engine coolant is a mixture of water and anticorrosion/antifreeze. To check the coolant level, the vehicle must be parked on level ground and the engine must be cool.

The coolant expansion tank is located on the passenger side of the engine compartment.

Warning!

In order to avoid any possibly serious burns:

- Use extreme caution when opening the hood if there are any signs of steam or coolant leaking from the cooling system, or if the coolant temperature gauge indicates that the coolant is overheated.
- Do not remove pressure cap on coolant reservoir if engine temperature is above 194°F (90°C). Allow engine to cool down before removing cap. The coolant reservoir contains hot fluid and is under pressure.
- Using a rag, slowly open the cap approximately 1/2 turn to relieve excess pressure. If opened immediately, scalding hot fluid and steam will be blown out under pressure.
- Do not spill antifreeze on hot engine parts. Antifreeze contains ethylene glycol which may burn if it comes into contact with hot engine parts.

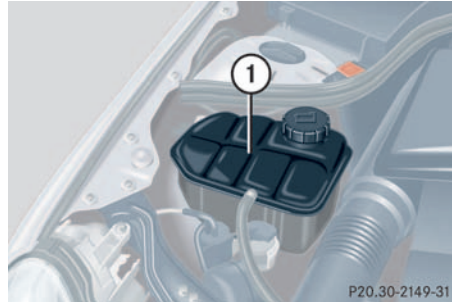

P20_30-2149-31

1 Coolant expansion tank

- ▶ Using a rag, turn the cap slowly approximately one half turn to the left to release any excess pressure.
- ▶ Continue turning the cap to the left and remove it.

The coolant level is correct if the level

- for cold coolant: reaches the black top part of the reservoir
- for warm coolant: is approx. 0.6 in (1.5 cm) higher
- ▶ Add coolant as required.
- ▶ Replace and tighten cap.

More information on coolant can be found in the “Technical data” section (▶ page 355).

Engine compartment

Battery

Your vehicle's battery is located on the right side of the engine compartment.

The battery should always be sufficiently charged in order to achieve its rated service life.

If you use your vehicle mostly for short distance trips, you will need to have the battery charge checked more frequently.

When replacing the battery, always use batteries approved by Mercedes-Benz.

If you do not intend to operate your vehicle for an extended period of time, consult an authorized Mercedes-Benz Center about steps you need to observe.



Observe all safety instructions and precautions when handling automotive batteries.



Risk of explosion



Keep flames or sparks away from battery. Do not smoke.



Battery acid is caustic. Do not allow it to come into contact with skin, eyes or clothing.

In case it does, immediately flush affected area with clear water and seek medical help if necessary.



Wear eye protection.



Keep children away.



Follow the instructions in this Operator's Manual.

Batteries contain materials that can harm the environment if disposed of improperly. Recycling of batteries is the preferred method of disposal. Many states require sellers of batteries to accept old batteries for recycling.

Windshield washer system and headlamp cleaning system*

Fluid for the windshield washer system and the headlamp cleaning system is supplied from the windshield washer reservoir. It has a capacity of approx. 6.4 US qt. (6 l).

During all seasons, add MB Windshield Washer Concentrate “S” to water. Pre-mix the windshield washer fluid in a suitable container.

- ▶ Refill the reservoir with MB Windshield Washer Concentrate and water (or commercially available pre-mixed windshield washer solvent / antifreeze, depending on ambient temperatures).

Always use washer solvent / antifreeze where temperatures may fall below freezing. Failure to do so could result in damage to the washer system / reservoir.

The windshield washer system on this vehicle is heated, so a fluid mixture produced for temperatures of approximately 14 °F (-10 °C) should be sufficient.

Warning!



Washer solvent / antifreeze is highly flammable. Do not spill washer solvent / antifreeze on hot engine parts, because it may ignite. You could be seriously burned.

More information can be found in the “Technical data” section (▷ page 357).

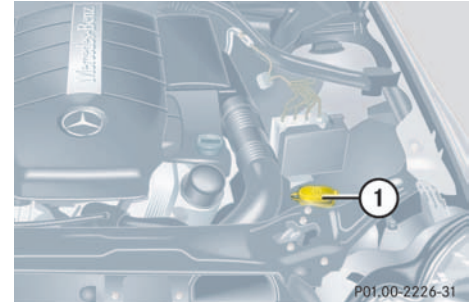

1 Washer fluid reservoir



Only use washer fluid which is suitable for plastic lenses. Improper washer fluid can damage the plastic lenses of the headlamps.

Tires and wheels

Tires and wheels

See your authorized Mercedes-Benz Center for information on tested and recommended rims and tires for summer and winter operation. They can also offer advice concerning tire service and purchase.

Warning!



Replace rims or tires with the same designation, manufacturer and type as shown on the original part. See your authorized Mercedes-Benz Center for further information. If incorrectly sized rims and tires are mounted:

- The wheel brakes or suspension components can be damaged.
- The correct operating clearance of the wheels and tires is no longer guaranteed.

Warning!



Worn, old tires can cause accidents. If the tire tread is badly worn, or if the tires have sustained damage, replace them.

When replacing rims, only use genuine Mercedes-Benz wheel bolts specified for the particular rim type. Failure to do so can result in the bolts loosening and possibly an accident.

Retread tires are not tested or recommended by Mercedes-Benz, since previous damage cannot always be recognized on retreads. Mercedes-Benz can therefore not assure the operating safety of the vehicle when such tires are used.

Important guidelines

- Only use sets of tires and rims of the same type and make.
- Tires must be of the correct size for the rim.
- Break in new tires for approximately 60 miles (100 km) at moderate speeds.
- Regularly check the tires and rims for damage.
- If vehicle is heavily loaded, check tire pressure and correct as required.
- Do not allow your tires to wear down too far. Adhesion properties on wet roads are sharply reduced at tread depths under $\frac{1}{8}$ in (3 mm).
- When replacing individual tires, you should mount new tires on the front wheels first (on vehicles with same-sized wheels all around).

Life of tires

The service life of a tire is dependent upon various factors including but not limited to:

- Driving style
- Tire pressure
- Distance driven

Warning!



Tires and spare tire should be replaced after six years, regardless of the remaining tread.



Keep unmounted tires in a cool, dry place with as little exposure to light as possible. Protect tires from contact with oil, grease and gasoline.

Direction of rotation

Unidirectional tires offer added advantages, such as better hydroplaning performance. To benefit, however, you must make sure that the tires rotate in the direction specified.

An arrow on the sidewall indicates the intended direction of tire rotation.

Tires and wheels

Checking tire inflation pressure

Warning!



If the tire pressure repeatedly drops

- check the tires for punctures from foreign objects
- check to see whether air is leaking from the valves or from around the rim

Correct the tire pressure only when tires are cold.

Regularly check your tire pressure at intervals of no more than 14 days.

If the tires are warm you should only correct the tire pressure if it is too low for current operating conditions.

A table on the fuel filler flap lists the specified tire inflation pressures for warm and cold tires as well as for various operating conditions.



The pressures listed for light loads are minimum values offering high driving comfort.

Increased inflation pressures listed for heavier loads may also be used for light loads. These higher pressures produce favorable handling characteristics. The ride of the vehicle, however, will be somewhat harder. Never exceed the max. values or inflate tires below the min. values listed in the fuel filler flap.

Tire pressure changes by approximately 1.5 psi (0.1 bar) per 18°F (10°C) of air temperature change. Keep this in mind when checking tire pressure where the temperature is different from the outside temperature.

Tire temperature and tire pressure are also increased while driving, depending on the driving speed and the tire load.

Warning!



Follow recommended inflation pressures.

Do not overinflate tires. Overinflating tires can result in sudden deflation (blowout) because they are more likely to become punctured or damaged by road debris, potholes, etc.

Do not underinflate tires. Underinflated tires wear unevenly, adversely affect handling and fuel economy, and are more likely to fail from being overheated.

Do not overload the tires by exceeding the specified vehicle capacity weight (as indicated by the label on the pillar in the driver's door opening). Overloading the tires can overheat them, possibly causing a blowout.

Check the spare tire periodically for condition and inflation. Spare tires will age and become worn over time even if never used, and thus should be inspected and replaced when necessary.

Rotating wheels

Warning!



Rotate front and rear wheels only if they are of the same size.

On vehicles with the same wheel size all around, wheels can be rotated every 3000 to 6000 miles (5000 to 10000 km), or sooner if necessary, according to the degree of tire wear. The same direction of tire rotation must be retained.

Rotate the wheels before the characteristic tire wear pattern becomes visible (shoulder wear on front wheels and tread center wear on rear wheels).

Thoroughly clean the inner side of the wheels after each rotation. Check and ensure proper tire inflation pressure.

Warning!



Have the tightening torque checked after changing a wheel. Wheels could become loose if not tightened with a torque of 80 ft.lb. (110 Nm).

Only use genuine Mercedes-Benz wheel bolts specified for your vehicle's rims.

Winter driving

Winter driving

Before the onset of winter have your vehicle winterized at an authorized Mercedes-Benz Center. This service includes:

- Check of anticorrosion and antifreeze concentration.
- Addition of cleaning concentrate to the water of the windshield and headlamp cleaning system. Add MB Concentrate “S” to a pre-mixed windshield washer solvent / antifreeze which is formulated for below freezing temperatures (▷ page 357).
- Battery test. Battery capacity drops with decreasing ambient temperature. A well charged battery helps to ensure that the engine can be started even at low ambient temperatures.
- Tire change. We recommend M+S rated radial-ply tires on all four wheels for the winter season.

Winter tires

Always use winter tires at temperatures below 39°F (4°C) and whenever wintry road conditions prevail. Use of winter tires is the only way to achieve the maximum effectiveness of the ABS and the ESP in winter operation.

For safe handling, ensure that all mounted winter tires are of the same make and have the same tread design.

Warning!



Winter tires with a tread depth under 0.16 in (4 mm) must be replaced. They are no longer suitable for winter operation.

Always observe the speed rating of the winter tires installed on your vehicle. If the maximum speed for which your tires are rated is below the speed rating of your vehicle, you must place a notice to this effect where it will be seen by the driver. Such notices are available from your tire dealer or from any authorized Mercedes-Benz Center.

Warning!



If you use your spare tire* when winter tires are fitted on the other wheels, be aware that the difference in tire characteristics may very well impair turning stability and that overall driving stability may be reduced. Adapt your driving style accordingly.

Have the spare tire replaced with a winter tire at the nearest authorized Mercedes-Benz Center.

Block heater*

(Canada only)

The engine is equipped with a block heater.

The electrical cable may be installed at your authorized Mercedes-Benz Center.

Snow chains

Snow chains should only be driven on snow-covered roads at speeds not to exceed 30 mph (50 km/h). Remove chains as soon as possible when driving on roads without snow.



When driving with snow chains, you may wish to deactivate the ESP (▷ page 78) before setting the vehicle in motion. This will improve the vehicle's traction.

Please observe the following guidelines when using snow chains:

- Using snow chains is not permissible with all wheel/tire combinations.
- Chains should only be used on the rear wheels. Follow the manufacturer's mounting instructions.
- Only use snow chains that are approved by Mercedes-Benz. Your authorized Mercedes-Benz Center will be glad to advise you on this subject.

Maintenance

Maintenance

We strongly recommend that you have your vehicle serviced by your authorized Mercedes-Benz Center, in accordance with the Service Booklet at the times called for by the FSS (Flexible Service System).

Failure to have the vehicle maintained in accordance with the Service Booklet at the designated times/mileage called for by the FSS may result in vehicle damage not covered by the Mercedes-Benz Limited Warranty.

FSS will notify you when your next service is due.

Approximately one month before your next service is due, one of the following messages will appear in the multifunction display while you are driving or when you switch on the ignition (example service A):

Service A in XXXXX miles (km)

Service A in XXX days

Service A in X day

Service A due now!



The type of service due is indicated in the multifunction display:



Minor service (A)



Major service (B)



The interval between services depends on your driving habits. A gentle driving style, moderate engine speeds and the avoidance of short distance trips will lengthen the interval between services.

Clearing the service indicator

The service indicator is automatically cleared after 30 seconds. You can also clear it yourself.

- ▶ Press the reset knob to the left in the instrument cluster (▷ page 111).

Service term exceeded

If you have exceeded the suggested service term, you will see the following message in the multifunction display:

Service A exceeded by XXXXX miles (km)

Service A exceeded by XXX days





Service A exceeded by X day

The Mercedes-Benz Center will reset the service indicator following a completed service.

Calling up the service indicator

- ▶ Switch ignition on.

The standard display of the control system appears (▷ page 114).

- ▶ Press button  or  on the multifunction steering wheel until FSS indicator with the service symbol  or  and the service deadline appears in the multifunction display.



If the battery is disconnected, the days of disconnection will not be included in the count shown by the service indicator. To arrive at the true service deadline, you will need to subtract these days from the days shown in the service indicator.





Do not confuse the service indicator with the engine oil level indicator .

Resetting the service indicator

In the event that the service on your vehicle is not carried out by an authorized Mercedes-Benz Center, you can reset the service indicator yourself.

- ▶ Switch ignition on.

The standard display of the control system appears (▷ page 114).

- ▶ Press button  or  on the multifunction steering wheel until the FSS indicator with the service symbol  or  and the service deadline appears in the multifunction display.
- ▶ Press the reset knob to the left in the instrument cluster for about four seconds.

This message appears in the multifunction display:

Do you want to reset service interval?

To confirm press button

- ▶ To confirm, hold down the reset knob until you hear a signal.

The service indicator now displays the reset interval.



If the service indicator was inadvertently reset, have a Mercedes-Benz Center correct it.

Only reset if the proper service has been performed. Resetting the system without performing the proper service as called for by the FSS will cause the FSS to incorrectly determine the next service interval which will result in engine damage not covered by the Mercedes-Benz Limited Warranty.

Vehicle care

Vehicle care

Cleaning and care of vehicle

Warning!



Many cleaning products can be hazardous. Some are poisonous, others are flammable. Always follow the instructions on the particular container. Always open your vehicle's doors or windows when cleaning the inside.

Never use fluids or solvents that are not designed for cleaning your vehicle.

While in operation, even while parked, your vehicle is subjected to varying external influences which, if gone unchecked, can attack the paintwork as well as the underbody and cause lasting damage.

Such damage is caused not only by extreme and varying climatic conditions, but also by:

- Air pollution
- Road salt
- Tar, gravel and stone chipping

To avoid paint damage, you should immediately remove:

- Grease and oil
- Fuel
- Coolant
- Brake fluid
- Insects
- Tree resins, etc.

Frequent washing reduces and /or eliminates the aggressiveness and potency of the above adverse influences.

More frequent washings are necessary to deal with unfavorable conditions:

- Near the ocean
- In industrial areas (smoke, exhaust emissions)
- During winter operation

You should check your vehicle from time to time for stone chipping or other damage. Any damage should be repaired as soon as possible to prevent corrosion.

In doing so, do not neglect the underbody of the vehicle. A prerequisite for a thorough check is a washing of the underbody followed by a thorough inspection. Damaged areas need to be re-undercoated.

Your vehicle has been treated at the factory with a wax-base rustproofing in the body cavities which will last for the lifetime of the vehicle. Post-production treatment is neither necessary nor recommended by Mercedes-Benz because of the possibility of incompatibility between materials used in the production process and others applied later.

We have selected car-care products and compiled recommendations which are specially matched to our vehicles and which always reflect the latest technology. You can obtain Mercedes-Benz approved car-care products at your authorized Mercedes-Benz Center.

Scratches, corrosive deposits, corrosion or damage due to negligent or incorrect care cannot always be removed or repaired with

the car-care products recommended here. In such cases it is best to seek aid at your authorized Mercedes-Benz Center.

The following topics deal with the cleaning and care of your vehicle and give important “how-to” information as well as references to Mercedes-Benz approved car-care products.

Additional information can be found in the “Vehicle Care Guide” booklet.

Power washer

When using a power washer for cleaning the vehicle, always observe the manufacturer’s operating instructions.



Vehicles with KEYLESS-GO*:

If a door handle is hit by a strong jet of water, and a SmartKey with KEYLESS-GO* is in close proximity, i.e. within approx. 3 ft. (approx. 1 m), the vehicle could be inadvertently locked or unlocked.



Never use a round nozzle to power wash tires. The intense jet of water can result in damage to the tire.

Always replace a damaged tire.

Always keep the jet of water moving across the surface. Do not aim directly at electrical parts, electrical connectors, seals, or other rubber parts.

Tar stains

Quickly remove tar stains before they dry and become more difficult to remove. A tar remover is recommended.

Vehicle care

Paintwork, painted body components

Mercedes-Benz approved Paint Care should be applied when water drops on the paint surface do not “bead up”, normally every 3 to 5 months, depending on climate and washing detergent used.

Mercedes-Benz approved Paint Cleaner should be applied if the paint surface shows signs of embedded dirt (i.e. loss of gloss).

Do not apply any of these products or wax if your vehicle is parked in the sun or if the hood is still hot.

Use the appropriate MB-Touch-Up Stick for quick and provisional repairs of minor paint damage (i.e. chips from stones, vehicle doors, etc.).

Engine cleaning

Prior to cleaning the engine compartment make sure to protect electrical components and connectors from contact with water and cleaning agents.

Corrosion protection, such as MB Anticorrosion Wax, should be applied to the engine compartment after every engine cleaning. Before applying, all control linkage bushings and joints should be lubricated. The poly-V-belt and all pulleys should be protected from any wax.

Vehicle washing

Do not use hot water or wash your vehicle in direct sunlight. Only use a mild car wash detergent, such as Mercedes-Benz approved Car Shampoo.

Thoroughly spray the vehicle with a diffused jet of water. Direct only a very weak spray towards the ventilation intake. Use plenty of water and rinse the sponge and chamois frequently.

Rinse with clear water and thoroughly dry with a chamois. Do not allow cleaning agents to dry on the finish.

Due to the width of the vehicle, fold in outside mirrors prior to running the vehicle through an automatic car wash to prevent damage to the mirrors.

In the winter, thoroughly remove all traces of road salt as soon as possible.

When washing the underbody, do not forget to clean the inner sides of the wheels.



Vehicles with KEYLESS-GO*:

If a door handle is hit by a strong jet of water, and a SmartKey with KEYLESS-GO* is in close proximity, i.e. within approx. 3 ft. (approx. 1 m), the vehicle could be inadvertently locked or unlocked.

Ornamental moldings

For regular cleaning and care of very dirty chrome-plated parts, use a chrome cleaner.

Headlamps, tail lamps, turn signal lenses

Use a mild car wash detergent, such as Mercedes-Benz approved Car Shampoo, with plenty of water.

To prevent scratches, never apply strong force and only use a soft, non-scratchy cloth when cleaning the lenses. Do not attempt to wipe dirty lenses with a dry cloth or sponge.

Cleaning the Distronic* system sensor cover



1 Distronic* system sensor cover

Use a mild car wash detergent, such as Mercedes-Benz approved Car Shampoo, with plenty of water to clean sensor cover 1.

To prevent scratches, never apply strong force and only use a soft, non-scratchy cloth when cleaning the sensor cover. Do not attempt to wipe dirty sensors with a dry cloth or sponge.



Restart the engine after cleaning sensor cover 1.

Vehicle care

Cleaning the Parktronic* system sensors

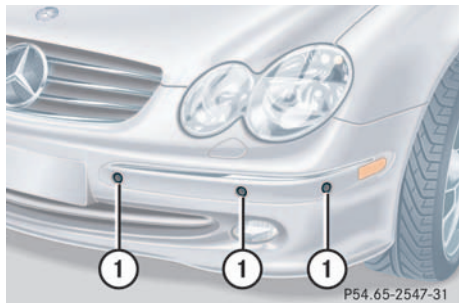

1 Parktronic* sensors

Use a mild car wash detergent, such as Mercedes-Benz approved Car Shampoo with plenty of water.

When using a steam cleaner or power washer, aim nozzle only briefly from a minimum distance of 4 in. (10 cm) at sensors 1.

To prevent scratches, never apply strong force and only use a soft, non-scratchy cloth when cleaning the sensor. Do not attempt to wipe dirty sensors with a dry cloth or sponge.

Wiper blades

Clean the wiper blade inserts with a clean cloth and detergent solution.



For safety reasons, switch off wipers and remove key from starter switch before cleaning the wiper blades, otherwise the wiper motor can suddenly turn on and cause injury.



Fold the windshield wiper arms back onto the windshield before turning the key in the starter switch.

Window cleaning

Use a window cleaning solution on all glass surfaces. An automotive glass cleaner is recommended.



For safety reasons, switch off wipers and remove key from starter switch before cleaning the windshield, otherwise the wiper motor can suddenly turn on and cause injury.

Light alloy wheels

Mercedes-Benz approved Wheel Care should be used for regular cleaning of the light alloy wheels.

If possible, clean wheels once a week with Mercedes-Benz approved Wheel Care, using a soft bristle brush and a strong spray of water.

Follow instructions on container.



Only use acid-free cleaning materials. Acid could lead to corrosion.

Instrument cluster

Use a gentle dishwashing detergent or mild detergent for delicate fabrics as a washing solution. Wipe with a cloth moistened in lukewarm solution. Do not use scouring agents.

Steering wheel and gear selector lever

Wipe with a damp cloth and dry thoroughly or clean with Mercedes-Benz approved Leather Care.

Cup holder

Use a gentle dishwashing detergent or mild detergent for delicate fabrics as a washing solution. Wipe with a cloth moistened in lukewarm solution. Do not use scouring agents.

Hard plastic trim items

Pour Mercedes-Benz approved Interior Care onto soft lint-free cloth and apply with light pressure.

Headliner

Clean with soft bristle brush, or use a dry-shampoo cleaner in case of excessive dirt.

Seat belts

The webbing must not be treated with chemical cleaning agents. Only use clear, lukewarm water and soap. Do not dry the webbing at temperatures above 176°F (80°C) or in direct sunlight.

Warning!



Do not bleach or dye seat belts as this may severely weaken them. In a crash they may not be able to provide adequate protection.

Leather upholstery

Using aftermarket seat covers or wearing clothing that have the tendency to give off coloring (e.g. when wet, etc.) may cause the upholstery to become permanently discolored. By lining the seats with a proper intermediate cover, contact-discoloration will be prevented.

Wipe leather upholstery with a damp cloth and dry thoroughly or clean with Mercedes-Benz approved Leather Care. Exercise particular care when cleaning perforated leather as its underside should not become wet.

Plastic and rubber parts

Do not use oil or wax on these parts.



Practical hints

What to do if ...?

Where will I find...?

Unlocking/locking in an emergency

Opening/closing in an emergency

Replacing bulbs

Replacing wiper blades

Flat tire

Battery

Jump starting

Towing the vehicle

Fuses

What to do if ...?



What to do if ...?



Lamps in instrument cluster

General information:

If a bulb in the instrument cluster fails to light up during the bulb self-check when

turning the SmartKey in the starter switch to position **2**, have it checked and replaced if necessary.

Problem	Possible cause	Suggested solution
 The yellow ESP warning lamp lights up while driving.	<p>The ESP is deactivated.</p> <p>Risk of accident!</p> <p>Adapt your speed and driving to the prevailing road conditions.</p>	<p>▶ Turn the ESP back on (▷ page 78).</p> <p>If the ESP cannot be turned back on, have the system checked at an authorized Mercedes-Benz Center as soon as possible.</p>
 The yellow ESP warning lamp flashes while driving.	<p>The ESP or traction control has come into operation because of detected traction loss in at least one tire.</p> <p>DISTRONIC* is deactivated.</p>	<p>▶ When driving off apply as little throttle as possible.</p> <p>▶ While driving, ease up on the accelerator.</p> <p>▶ Adapt your speed and driving to the prevailing road and weather conditions.</p> <p>▶ Do not deactivate the ESP – exceptions: (▷ page 78).</p> <p>Failure to follow these instructions increases the risk of accidents.</p>

Problem	Possible cause	Suggested solution
 The yellow ABS malfunction indicator lamp comes on while driving.	<p>The ABS has detected a malfunction and has switched off. The BAS and the ESP are also switched off (see messages in display).</p> <p>The brake system is still functioning normally but without the ABS available.</p> <p>The charging voltage has fallen below 10 volts and the ABS has switched off.</p>	<ul style="list-style-type: none"> ▶ Continue driving with added caution. Wheels will lock during hard braking, reducing steering capability. ▶ Have the system checked at an authorized Mercedes-Benz Center as soon as possible. <p>Failure to follow these instructions increases the risk of an accident.</p> <ul style="list-style-type: none"> ▶ When the voltage is above this value again, the ABS is operational again. ▶ If necessary, have the generator and battery checked.
 The red DTR indicator lamp lights up while driving.	<p>You are too close to the vehicle in front of you to maintain selected speed.</p>	<ul style="list-style-type: none"> ▶ Apply the brakes immediately to increase the following distance.
 The red DTR indicator lamp comes on while driving and you hear a warning sound.	<ul style="list-style-type: none"> • You are gaining too rapidly on the vehicle ahead of you. • The distance warning system has recognized a stationary obstacle on your probable line of travel. 	<ul style="list-style-type: none"> ▶ Apply the brakes immediately. ▶ Carefully observe the traffic situation. You may need to brake or maneuver to avoid hitting an obstacle.

What to do if ...?

Problem	Possible cause	Suggested solution
SRS The red SRS indicator lamp lights up while driving.	There is a malfunction in the restraint systems. The airbags or emergency tensioning device (ETD) could deploy unexpectedly or fail to activate in an accident.	► Drive with added caution to the nearest authorized Mercedes-Benz Center.

Warning!



In the event that a malfunction of the SRS is indicated as outlined above, the SRS may not be operational. For your safety, we strongly recommend that you visit an authorized Mercedes-Benz Center immediately to have the system checked; otherwise the SRS may not be activated when needed in an accident, which could result in serious or fatal injury, or it might deploy unexpectedly and unnecessarily, which could result in an accident and/or injury to you or to others.

Problem	Possible cause	Suggested solution
<p>BRAKE (except Canada)</p> <p> (Canada only)</p> <p>The red brake warning lamp lights up while driving and you hear a warning sound.</p>	<p>You are driving with the parking brake set.</p>	<p>► Release the parking brake (▷ page 45).</p>
<p>The red brake warning lamp lights up while driving.</p>	<p>There is insufficient brake fluid in the reservoir.</p>	<p>► Risk of accident! Carefully stop the vehicle and notify an authorized Mercedes-Benz Center. Do not add brake fluid! This will not solve the problem.</p>

Warning!





Driving with the brake warning lamp illuminated can result in an accident. Have your brake system checked immediately if the brake warning lamp stays on. Don't add brake fluid before checking the brake system.



Overfilling the brake fluid reservoir can result in spilling brake fluid on hot engine parts and the brake fluid catching fire. You can be seriously burned.



If you find that the brake fluid in the brake fluid reservoir has fallen to the minimum mark or below, have the brake system checked for brake pad thickness and leaks.

What to do if ...?

Problem	Possible cause	Suggested solution
<p> The yellow “CHECK ENGINE” malfunction indicator lamp comes on while driving.</p>	<p>There is a malfunction in:</p> <ul style="list-style-type: none"> • The fuel management system • The ignition system • The emission control system • Systems which impact emissions <p>Such malfunctions may result in excessive emissions values and may switch the engine to its Limp-Home Mode (emergency operation).</p>	<p>▶ Have the vehicle checked as soon as possible by an authorized Mercedes-Benz Center. An on-board diagnostic connector is used by the service station to link the vehicle to the shop diagnostics system. It allows the accurate identification of system malfunctions through the read-out of diagnostic trouble codes. It is located in the front left area of the footwell next to the parking brake pedal.</p>
	<p>The fuel cap is not closed tightly.</p>	<p>▶ Check the fuel cap.</p>
	<p>Your gas tank is empty.</p>	<p>▶ After refuelling, start the engine three or four times in succession.</p> <p>The Limp-Home mode is canceled. You do not need to have your vehicle checked.</p>
<p> The red seat belt warning lamp blinks for a brief period after starting the engine.</p>	<p>The warning lamp reminds you to fasten seat belts.</p>	<p>▶ Fasten your seat belt.</p>
<p> The yellow fuel tank reserve warning lamp lights up while driving.</p>	<p>The fuel level has gone below the reserve mark.</p>	<p>▶ Refuel at the next gas station (▷ page 251).</p>

Problem	Possible cause	Suggested solution
 <p>The red coolant warning lamp lights up when the engine is running.</p>	There is insufficient coolant in the reservoir.	▶ Add coolant to prevent engine from overheating (▷ page 256).
	If this warning lamp lights up frequently, there is a leak in the cooling system.	▶ Have the cooling system checked.
	If the coolant level is correct, the electric radiator fan may be broken.	▶ If the coolant temperature is below 257 °F (125 °C), you can continue driving to the nearest authorized Mercedes-Benz Center. ▶ Avoid high engine loads (e.g. driving uphill) and stop-and-go driving.
 <p>The red coolant warning lamp lights up while driving and you hear a warning sound.</p>	The coolant temperature has exceeded 257 °F (125 °C).	▶ Stop as soon as possible and allow the engine and coolant to cool down.

Warning!



Driving when your engine is badly overheated can cause some fluids which may have leaked into the engine compartment to



catch fire. You could be seriously burned.

Steam from an overheated engine can cause serious burns and can occur just by opening the engine hood. Stay away from the engine if you see or hear steam coming from it.

Turn off the engine, get out of the vehicle and do not stand near the vehicle until it cools down.

What to do if ...?

Lamp in center console

Problem	Possible cause	Suggested solution
 <p>The indicator lamp lights up.</p>	<p>A BabySmart™ child seat is installed on the front passenger seat. Therefore the front passenger airbag is switched off.</p> <p>The system is malfunctioning when there is no BabySmart™ child seat installed on the front passenger seat.</p>	<ul style="list-style-type: none"> ▶ Have the system checked as soon as possible by an authorized Mercedes-Benz Center.
 <p>The indicator lamp does not light up with a BabySmart™ child seat properly installed on the front passenger seat.</p>	<p>The system is malfunctioning.</p>	<ul style="list-style-type: none"> ▶ Make sure that there is nothing between seat cushion and child seat and check installation of the child seat. ▶ If the light remains out, have the system checked as soon as possible by an authorized Mercedes-Benz Center. <p>Do not use the BabySmart™ restraint to transport children on the front passenger seat until the system has been repaired.</p>

Messages in the display

The control system shows warning and malfunction messages in the multifunction display.

Certain warning and malfunction messages are accompanied by an audible signal.

Address these messages accordingly and follow the additional instructions given in this Operator's Manual.

Selecting the malfunction memory menu in the control system (▷ page 122) displays both cleared and uncleared messages.

High-priority messages appear in the multifunction display in red color.

Certain messages of high priority cannot be cleared from the multifunction display using the reset knob (▷ page 111).

Other high priority messages and messages of less immediate priority (regular display colors) can be cleared from the multifunction display using the reset knob and are then stored in the malfunction message memory (▷ page 122).

Warning!



All categories of messages contain important information which should be taken note of and, where a malfunction is indicated, addressed as soon as possible at an authorized Mercedes-Benz Center.

Failure to repair the condition noted may cause damage not covered by the Mercedes-Benz Limited Warranty, or result in property damage or personal injury.

Warning!



No messages will be displayed if either the instrument cluster or the multifunction display is inoperative.

Contact your nearest authorized Mercedes-Benz Center.



Turning the key in starter switch to position **2**, or pressing the KEY-LESS-GO* start/stop button (if so equipped) twice to position **2** causes all lamps as well as the multifunction display to come on. Ensure that they are all in working order before starting your journey.

On the pages that follow, you will find a compilation of all the messages that may appear in the display. High priority messages appear on a red background.

What to do if ...?

Display	Possible cause	Suggested solution
<p>ABS</p> <p>Defective! Visit workshop!</p>	<p>The ABS has detected a malfunction and has switched off. The ESP and the BAS are also deactivated.</p> <p>The brake system is still functioning normally but without the ABS available.</p>	<ul style="list-style-type: none"> ▶ Continue driving with added caution. Wheels will lock during hard braking, reducing steering capability. ▶ Have the system checked at an authorized Mercedes-Benz Center as soon as possible. <p>Failure to follow these instructions increases the risk of accident.</p>
<p>Display defective! Visit workshop!</p>	<p>ABS or the ABS display is malfunctioning.</p>	<ul style="list-style-type: none"> ▶ Continue driving with added caution. Wheels will lock during hard braking, reducing steering capability. ▶ Have the system checked at an authorized Mercedes-Benz Center as soon as possible. <p>Failure to follow these instructions increases the risk of accident.</p>



Display	Possible cause	Suggested solution
<p>ABS</p> <p>Anti-lock braking system not working!</p>	<p>The charging voltage has fallen below 10 volts and the ABS has switched off.</p> <p>The brake system is still functioning normally but without the ABS available.</p>	<ul style="list-style-type: none"> ▶ When the voltage is above this value again, the ABS is operational again. ▶ Continue driving with added caution. Wheels will lock during hard braking, reducing steering capability. ▶ Have the system checked at an authorized Mercedes-Benz Center as soon as possible. <p>Failure to follow these instructions increases the risk of accident.</p>
<p>BAS</p> <p>not available See operator's manual</p>	<p>The charging voltage has fallen below 10 volts and the BAS has switched off.</p> <p>The brake system is still functioning normally but without the BAS available.</p>	<ul style="list-style-type: none"> ▶ When the voltage is above this value again, the BAS is operational again. ▶ Have the system checked at an authorized Mercedes-Benz Center if you see the warning message for a longer period of time. <p>Failure to follow these instructions increases the risk of accident.</p>

What to do if ...?

Display		Possible cause	Suggested solution
BAS	Defective! Visit workshop	The BAS has detected a malfunction and switched off.	<ul style="list-style-type: none"> ▶ Continue driving with added caution. ▶ Have the system checked at an authorized Mercedes-Benz Center as soon as possible. <p>Failure to follow these instructions increases the risk of accident.</p>
	Display defective Visit workshop	BAS or the BAS display is malfunctioning.	<ul style="list-style-type: none"> ▶ Continue driving with added caution. ▶ Have the system checked at an authorized Mercedes-Benz Center as soon as possible. <p>Failure to follow these instructions increases the risk of accident.</p>
	Brake wear Visit workshop	The brake pads have reached their wear limit.	<ul style="list-style-type: none"> ▶ Have the brake pads replaced as soon as possible.



Brake pad thickness must be visually checked by a qualified technician at the intervals specified in the Service Booklet.

Display		Possible cause	Suggested solution
	(USA only) Brake fluid	There is insufficient brake fluid in the reservoir.	► Risk of accident! Stop the vehicle and notify an authorized Mercedes-Benz Center. Do not add brake fluid! This will not solve the problem.
	(Canada only) Visit workshop		

Warning!





Driving with this message displayed can result in an accident. Have your brake system checked immediately. Don't add brake fluid before checking the brake system. Overfilling the brake fluid reservoir can result in spilling brake fluid on hot engine parts and the brake fluid catching fire. You can be seriously burned.



If you find that the brake fluid in the brake fluid reservoir has fallen to the minimum mark or below, have the brake system checked for brake pad thickness and leaks.

What to do if ...?

Display	Possible cause	Suggested solution
 <p>Key Check battery!</p>	The SmartKey with KEYLESS-GO* batteries are discharged.	▶ Change the batteries (▷ page 312).
<p>Key not recognized!</p>	<p>The SmartKey with KEYLESS-GO* is not recognized while the engine is running because</p> <ul style="list-style-type: none"> • the key is not in the vehicle • there is strong radio-frequency interference <p>The SmartKey with KEYLESS-GO* is momentarily not recognized.</p>	<p>▶ Stop the vehicle as soon as it is safe to do so.</p> <p>▶ Search for the key.</p> <p>Otherwise the vehicle cannot be centrally locked nor can the engine be started again after the engine has been stopped.</p> <p>▶ Change the position of the key in the vehicle.</p> <p>▶ Operate the vehicle with the key in the starter switch if necessary.</p>
<p>Key recognized in vehicle</p>	A SmartKey with KEYLESS-GO* left in the vehicle was recognized while locking the vehicle from the outside.	▶ Take the key out of the vehicle.
<p>Keyless Go Check system</p>	The KEYLESS-GO* system is malfunctioning.	▶ Visit an authorized Mercedes-Benz Center as soon as possible.

Display	Possible cause	Suggested solution
 <p>Key do not forget key</p>	<p>This display appears (for a maximum of 60 seconds) if the driver's door is opened with the engine shut off and no key in the starter switch. Message is only a reminder.</p>	<ul style="list-style-type: none"> ▶ Insert key in the starter switch. ▶ Take the SmartKey with KEY-LESS-GO* with you when leaving the vehicle.
 <p>Coolant Check level</p>	<p>The coolant level is too low.</p>	<ul style="list-style-type: none"> ▶ Add coolant (▷ page 256). ▶ If you have to add coolant frequently, have the cooling system checked by an authorized Mercedes-Benz Center.

Warning!



Do not spill antifreeze on hot engine parts. Antifreeze contains ethylene glycol which may burn if it comes into contact with hot engine parts. You can be seriously burned.



Do not ignore the low engine coolant level warning. Extended driving with the message and symbol displayed may cause serious engine damage not covered by the Mercedes-Benz Limited Warranty.

Do not drive without sufficient amount of coolant in the cooling system. The engine will overheat, causing major engine damage.

What to do if ...?

Display	Possible cause	Suggested solution
 <p>Coolant Stop, engine off!</p>	<p>The coolant is too hot.</p>	<ul style="list-style-type: none"> ▶ Stop the vehicle and turn off the engine. ▶ Only start the engine again after the message disappears. You could otherwise damage the engine.

Warning!



Driving when your engine is badly overheated can cause some fluids which may have leaked into the engine compartment to catch fire. You could be seriously burned.



Steam from an overheated engine can cause serious burns and can occur just by opening the engine hood. Stay away from the engine if you see or hear steam coming from it.

Turn off the engine, get out of the vehicle and do not stand near the vehicle until it cools down.



During severe operating conditions and stop-and-go city traffic, the coolant temperature may rise close to 248°F (120°C).



The engine should not be operated with the coolant temperature above 248°F (120°C). Doing so may cause serious engine damage which is not covered by the Mercedes-Benz Limited Warranty.

Display	Possible cause	Suggested solution
 <p>Coolant Stop, engine off!</p>	<p>The poly-V-belt could be broken.</p>	<ul style="list-style-type: none"> ▶ Stop immediately and check the poly-V-belt. <p>If it is broken:</p> <ul style="list-style-type: none"> ▶ Do not continue to drive. Otherwise the engine will overheat due to an inoperative water pump which may result in damage to the engine. Notify an authorized Mercedes-Benz Center. <p>If it is intact:</p> <ul style="list-style-type: none"> ▶ Do not continue to drive the vehicle with this message displayed. Doing so could result in serious engine damage that is not covered by the Mercedes-Benz Limited Warranty.
 <p>Coolant Visit workshop</p>	<p>The cooling fan for the coolant is malfunctioning.</p>	<ul style="list-style-type: none"> ▶ Observe the coolant temperature display. ▶ Have the fan replaced as soon as possible.

What to do if ...?

Display	Possible cause	Suggested solution	
Distronic	External interference Reactivate!	Distronic* is switched off and is temporarily unavailable.	▶ Try activating DISTRONIC* again later.
	Unavailable! see oper. manual	Distronic* is switched off because the DISTRONIC* cover in the radiator grille is dirty.	▶ Clean the DISTRONIC* cover in the radiator grille (▷ page 271). ▶ Restart the vehicle.
	Visit workshop!	Distronic* is malfunctioning or the display is malfunctioning.	▶ Visit an authorized Mercedes-Benz Center as soon as possible.
P	Selector lever in park position	You have turned off the engine with the KEYLESS-GO* start/stop button and opened the driver's door.	▶ Place the selector lever in position P .
	Doors open!	You are attempting to drive with one or more doors open.	▶ Close the doors.
	Visit workshop!	There may be a malfunction in the <ul style="list-style-type: none"> • fuel injection system • ignition system • exhaust system • fuel system 	▶ Have the measuring system checked by an authorized Mercedes-Benz Center.

Display	Possible cause	Suggested solution
ESP not available! See operator's manual	The charging voltage has fallen below 10 volts and the ESP has switched off. The self-diagnosis has not been completed.	<ul style="list-style-type: none"> ▶ When the voltage is above this value again, the ESP is operational again. ▶ If necessary, have the generator and battery checked. The display will clear itself after driving a short distance at more than 12 mph (20 km/h).
Display defective Visit workshop!	The ESP or the ESP display is malfunctioning.	<ul style="list-style-type: none"> ▶ Continue driving with added caution. ▶ Visit an authorized Mercedes-Benz Center as soon as possible. Failure to follow these instructions increases the risk of accident.

What to do if ...?

Display	Possible cause	Suggested solution
ESP Defective! Visit workshop!	The ESP is deactivated because of a malfunction or interrupted power supply. The ABS may still be operational.	<ul style="list-style-type: none"> ▶ With the vehicle stationary and the engine running, turn the steering wheel completely to the left and then to the right to synchronize the ESP. <p>If the ESP message does not go out:</p> <ul style="list-style-type: none"> ▶ Continue driving with added caution. ▶ Visit an authorized Mercedes-Benz Center as soon as possible. <p>Failure to follow these instructions increases the risk of accident.</p>
 Engine oil level Stop, engine off!	There is no oil in the engine. There is a danger of engine damage.	<ul style="list-style-type: none"> ▶ Carefully bring the vehicle to a halt as soon as possible. ▶ Turn off the engine. ▶ Add engine oil.

Display	Possible cause	Suggested solution
 Engine oil level Reduce oil level!	You have added too much engine oil. There is a risk of damaging the engine or the catalytic converter.	<ul style="list-style-type: none"> ▶ Have oil siphoned. Observe all legal requirements with respect to its disposal.
Engine oil Visit workshop!	The engine oil has dropped to a critical level. There is water in the oil.	<ul style="list-style-type: none"> ▶ Check the engine oil level (▷ page 254) and add oil as required. ▶ If you must add engine oil frequently, have the engine checked for possible leaks. ▶ Have the oil checked.
Engine oil level Visit workshop!	The measuring system is malfunctioning.	<ul style="list-style-type: none"> ▶ Have the measuring system checked by an authorized Mercedes-Benz Center.

When the Engine oil - Visit workshop! message appears while the engine is running and at operating temperature, the engine oil level has dropped to approximately the minimum mark on the dipstick.





When this occurs, the warning will first come on intermittently and then stay on if the oil level drops further.

If no oil leaks are noted, continue to drive to the nearest service station where the engine oil should be topped to the “full” mark on the dipstick with an approved oil.



The engine oil level warnings should not be ignored. Extended driving with the symbol displayed could result in serious engine damage that is not covered by the Mercedes-Benz Limited Warranty.



What to do if ...?

Display	Possible cause	Suggested solution
 Reserve fuel	The fuel level has dropped below the reserve mark.	▶ Refuel at the next gas station (▷ page 251).
 Hood open!	You are driving with the hood open.	▶ Close the hood (▷ page 254).
 Remove key	You have forgotten to remove the key.	▶ Remove the key from the starter switch.
Replace key!	No additional code available for SmartKey or SmartKey with KEYLESS-GO*	▶ Visit an authorized Mercedes-Benz Center as soon as possible.
 Lamp sensor Visit workshop!	The lamp sensor is malfunctioning. The headlamps switch on automatically.	▶ In the control system, set lamp operation to manual (▷ page 129). ▶ Switch on headlamps using the exterior lamp switch.
Low beam, left	The left low beam lamp is malfunctioning.	▶ Visit an authorized Mercedes-Benz Center as soon as possible.
Low beam, right	The right low beam lamp is malfunctioning.	▶ Visit an authorized Mercedes-Benz Center as soon as possible.
Display defective! Visit workshop!	The display for the lamps or the system is malfunctioning.	▶ Visit an authorized Mercedes-Benz Center as soon as possible.
Turn signal rear left Substitute lamp on!	The left rear turn signal lamp is malfunctioning. A backup bulb is being used.	▶ Replace the bulb as soon as possible.
Turn signal rear right Substitute lamp on!	The right rear turn signal lamp is malfunctioning. A backup bulb is being used.	▶ Replace the bulb as soon as possible.



Display	Possible cause	Suggested solution
 Turn signal in left mirror	The left turn signal in the side mirror is malfunctioning. This message will only appear if all light emitting diodes have stopped working.	▶ Have the LEDs replaced as soon as possible.
Side marker lamp, front left	The front left side marker lamp is malfunctioning.	▶ Replace the bulb as soon as possible.
Side marker lamp front right	The front right side marker lamp is malfunctioning.	▶ Replace the bulb as soon as possible.
Turn signal in right mirror	The right turn signal in the side mirror is malfunctioning. This message will only appear if all light emitting diodes have stopped working.	▶ Have the LEDs replaced as soon as possible.
Turn signal front left Substitute lamp on!	The left front turn signal lamp is malfunctioning. A backup bulb is being used.	▶ Replace the bulb as soon as possible.
Turn signal front right Substitute lamp on!	The right front turn signal lamp is malfunctioning. A backup bulb is being used.	▶ Replace the bulb as soon as possible.
Stop lamp Visit workshop!	Stop lamp illumination is delayed or lamp is permanently on.	▶ Visit an authorized Mercedes-Benz Center as soon as possible.
Turn off lamps!	Lamps have been turned on although the key in the starter switch is in position 0 .	▶ Visit an authorized Mercedes-Benz Center as soon as possible.
Stop lamp, left	The left brake lamp is malfunctioning.	▶ Visit an authorized Mercedes-Benz Center as soon as possible.

What to do if ...?

Display	Possible cause	Suggested solution
 Stop lamp, right	The right brake lamp is malfunctioning.	▶ Visit an authorized Mercedes-Benz Center as soon as possible.
3rd stop lamp	The high mounted brake lamp is malfunctioning.	▶ Visit an authorized Mercedes-Benz Center as soon as possible.
High beam, left	The left high beam lamp is malfunctioning.	▶ Replace the bulb as soon as possible.
High beam, right	The right high beam lamp is malfunctioning.	▶ Replace the bulb as soon as possible.
License plate lamp, left	The left license plate lamp is malfunctioning.	▶ Replace the bulb as soon as possible.
License plate lamp, right	The right license plate lamp is malfunctioning.	▶ Replace the bulb as soon as possible.
Front foglamp, left	The left front fog lamp is malfunctioning.	▶ Replace the bulb as soon as possible.
Front foglamp, right	The right front fog lamp is malfunctioning.	▶ Replace the bulb as soon as possible.
Back- up lamp, left	The left backup lamp is malfunctioning.	▶ Replace the bulb as soon as possible.

Display		Possible cause	Suggested solution
	Back- up lamp, right	The right backup lamp is malfunctioning.	▶ Replace the bulb as soon as possible.
	Tail lamp, left Substitute lamp on!	The left tail lamp is malfunctioning. A backup bulb is being used.	▶ Visit an authorized Mercedes-Benz Center as soon as possible.
	Tail lamp, right Substitute lamp on!	The right tail lamp is malfunctioning. A backup bulb is being used.	▶ Visit an authorized Mercedes-Benz Center as soon as possible.
	Parking lamp, front left Substitute lamp on	The left parking lamps are malfunctioning. A backup bulb is being used.	▶ Visit an authorized Mercedes-Benz Center as soon as possible.
	Parking lamp, front right Substitute lamp on	The right parking lamps are malfunctioning. A backup bulb is being used.	▶ Visit an authorized Mercedes-Benz Center as soon as possible.
BRAKE 	(USA only) Parking brake (Canada only) release brake!	You are driving with the parking brake set.	▶ Release the parking brake (▷ page 45).
	Seat belt system Visit workshop	The seat belt system is malfunctioning.	▶ Visit an authorized Mercedes-Benz Center as soon as possible.

What to do if ...?

Display	Possible cause	Suggested solution
 Front passenger seat belt Please fasten belt!	The display reminds you and your passengers to fasten seat belts.	▶ Fasten the seat belts.
Driver's seat belt Fasten seat belt!	The display reminds you and your passengers to fasten seat belts.	▶ Fasten the seat belts.
 Steering oil Visit workshop!	The steering gear oil level is too low. There is a danger of steering gear damage.	▶ Have the system checked by an authorized Mercedes-Benz Center.







Warning!



If the level of steering gear oil in reservoir is too low, the steering power assistance could fail. Much greater effort will then be needed to turn the steering wheel.



Do not add steering oil without checking the steering system.

Do not drive the vehicle. Have the system checked at your authorized Mercedes-Benz Center as soon as possible.

Display	Possible cause	Suggested solution
 defective Visit workshop! <hr/> Tele Aid battery Visit workshop!	One or more main functions of the Tele Aid system are malfunctioning. The emergency power battery for the Tele Aid system is malfunctioning. If the vehicle battery is also dead, Tele Aid will not be operational.	► Have the Tele Aid system checked by an authorized Mercedes-Benz Center. ► Have the Tele Aid system checked by an authorized Mercedes-Benz Center.
 Function Not available	This display appears if button  or  on the multifunction steering wheel is pressed and the vehicle is not equipped with a telephone.	
 Close trunk lid!	This message will appear whenever the trunk lid is open.	► Close the trunk lid.
 Washer fluid Check level	The fluid level has dropped to about $\frac{1}{3}$ of total reservoir capacity.	► Add washer fluid (▷ page 259).

What to do if ...?

Display	Possible cause	Suggested solution
 VISIT WORKSHOP!	<p>The battery was charged with a battery charger or jump started.</p> <p>The battery is no longer charging. Possible causes:</p> <ul style="list-style-type: none"> • alternator malfunctioning • broken poly-V-belt <p>Do not forget that the brake system requires electrical energy and may be operating with restricted capability. Considerably greater brake pedal force is required and the stopping distance is increased.</p>	<ul style="list-style-type: none"> ▶ Have the battery checked at a service station. ▶ Stop immediately and check the poly-V-belt. <p>If it is broken:</p> <ul style="list-style-type: none"> ▶ Do not continue to drive. Otherwise the engine will overheat due to an inoperative water pump which may result in damage to the engine. Notify an authorized Mercedes-Benz Center. <p>If it is intact:</p> <ul style="list-style-type: none"> ▶ Drive immediately to the nearest authorized Mercedes-Benz Center. Adjust driving to be consistent with reduced braking responsiveness.

Display	Possible cause	Suggested solution
 Undervoltage Charge battery	The battery has insufficient voltage.	▶ Start the engine (▷ page 43).
Undervoltage Switch off consumers	The battery has insufficient voltage.	▶ Turn off unnecessary electrical consumers.
Cruise Control	Visit workshop!	Cruise control or DISTRONIC* is malfunctioning.
 Restraint system defective Visit workshop!	The system is malfunctioning.	▶ Drive with added caution to the nearest authorized Mercedes-Benz Center.



Warning!



In the event a malfunction of the SRS is indicated as outlined above, the SRS may not be operational. For your safety, we strongly recommend that you visit an authorized Mercedes-Benz Center immediately to have the system checked; otherwise the

SRS may not be activated when needed in an accident, which could result in serious or fatal injury, or it might deploy unexpectedly and unnecessarily which could also result in injury.

What to do if ...?

Display	Possible cause	Suggested solution
 Display defective Visit workshop!	The instrument cluster display is malfunctioning.	<ul style="list-style-type: none"> ▶ Continue driving with added caution. ▶ Visit an authorized Mercedes-Benz Center as soon as possible.
	The displays for several systems have malfunctioned. Some systems themselves may also have malfunctioned.	<ul style="list-style-type: none"> ▶ Have the electronic systems checked by an authorized Mercedes-Benz Center.
 Display defective Visit workshop!	<p>Certain electronic systems are unable to relay information to the control system. The following systems may have failed:</p> <ul style="list-style-type: none"> • Coolant temperature display • Tachometer • Cruise control display 	<ul style="list-style-type: none"> ▶ Have the electronic systems checked by an authorized Mercedes-Benz Center.

Where will I find...?

First aid kit

The first aid kit is stored in left hand side of the trunk.



- ▶ Loosen Velcro fastener **1**.
- ▶ Remove first aid kit **2**.



Check expiration dates and contents for completeness at least once a year and replace missing/expired items.

Vehicle tool kit

The vehicle tool kit is stored in the compartment underneath the trunk floor.

The following is included:

- Towing eye bolt
- Alignment bolt
- Wheel wrench
- Vehicle jack
- Wheel bolts

Removing the vehicle tool kit

- ▶ Lift up the trunk floor cover.
- ▶ Loosen retaining screw **1** in the middle of storage well casing **2**. Remove storage well casing **2**.
- ▶ Remove vehicle tool kit storage well casing **5**.

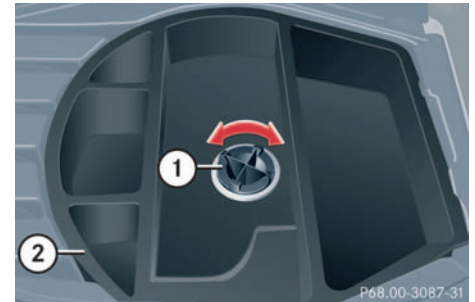

- 1** Retaining screw
- 2** Storage well casing

Where will I find...?

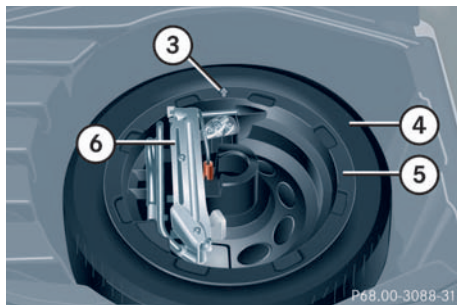

- 3 Arrow
- 4 Minispare wheel
- 5 Vehicle tool kit storage well casing
- 6 Vehicle tool kit
 - Wheel wrench
 - Vehicle jack



Arrow **3** on vehicle tool kit storage well casing **5** must point in the direction of travel. Otherwise you cannot place the storage well casing on top and secure the Minispare wheel with retaining screw **1** (▷ page 305).

Vehicle jack

Warning!



The jack is designed exclusively for jacking up the vehicle at the jack take-up brackets built into both sides of the vehicle. To help avoid personal injury, use the jack only to lift the vehicle during a wheel change. Never get beneath the vehicle while it is supported by the jack. Keep hands and feet away from the area under the lifted vehicle. Always firmly set parking brake and block wheels before raising vehicle with jack.

Do not disengage parking brake while the vehicle is raised. Be certain that the jack is always vertical (plumb line) when in use, especially on hills. Always try to use the jack on a level surface. Make sure that the jack arm is fully seated in the jack take-up bracket. Always lower the vehicle onto sufficient capacity jackstands before working under the vehicle.

The vehicle jack is stored in the space underneath the trunk floor together with the vehicle tool kit in the vehicle tool kit storage well casing.

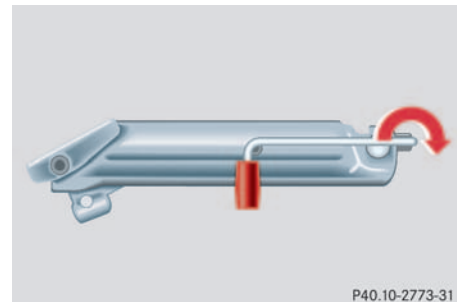

- ▶ Remove the vehicle jack from its compartment.
- ▶ Push the crank handle up.

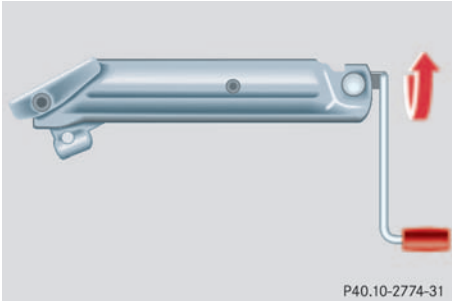

- ▶ Turn the crank handle clockwise until it engages (operational position).

Before storing the vehicle jack in its compartment:

- It should be fully collapsed
- The handle must be folded in (storage position)

Minispare wheel

The Minispare wheel is located in the compartment underneath the trunk floor.

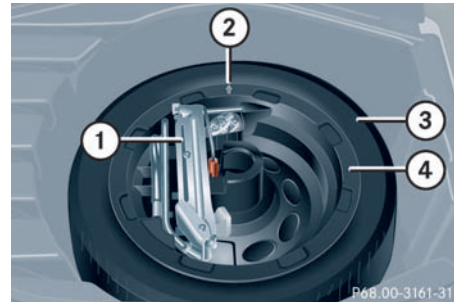

- 1 Vehicle tool kit
Wheel wrench
Jack
- 2 Arrow
- 3 Minispare wheel
- 4 Vehicle tool kit storage well casing

Removing the Minispare wheel

- ▶ Lift trunk floor cover and engage trunk floor handle in upper edge of trunk.
- ▶ Loosen the retaining screw (▷ page 305) in the middle of storage well casing. Remove the storage well casing.
- ▶ Remove vehicle tool kit storage well casing **4**.
- ▶ Remove Minispare wheel **3**.

Where will I find...?

Storing the Minispare wheel

- ▶ Place Minispare wheel **3** in wheel well.
- ▶ Place vehicle tool kit storage well casing **4** over the Minispare wheel. Be sure that the arrow **2** on storage well casing **4** points in the direction of travel.
- ▶ Place storage well casing (▷ page 305) over the vehicle tool kit storage well casing **4** and turn the retaining screw (▷ page 305) clockwise as far as it will go to secure the Minispare wheel.



The arrow **2** on vehicle tool kit storage well casing **4** must point in the direction of travel, otherwise you cannot place the storage well casing (▷ page 305) on top and secure the Minispare wheel with the retaining screw (▷ page 305).



To prevent damage, always disengage trunk floor handle from upper edge of trunk and lower trunk floor before closing the trunk lid.

Warning!



The dimensions of the Minispare wheel are different from those of the road wheels. As a result, the vehicle handling characteristics change when driving with a Minispare wheel mounted.

The Minispare wheel should only be used temporarily, and should be replaced with a regular road wheel as quickly as possible.

In the case of a flat tire, you may temporarily use the Minispare wheel when observing the following restrictions:

- Do not exceed a vehicle speed of 50 mph (80 km/h).
- Drive to the nearest tire repair facility to have the flat tire repaired or replaced as appropriate.
- Do not operate vehicle with more than one Minispare wheel mounted.

More information can be found in the “Technical data” section (▷ page 345).

Minispare wheel bolts

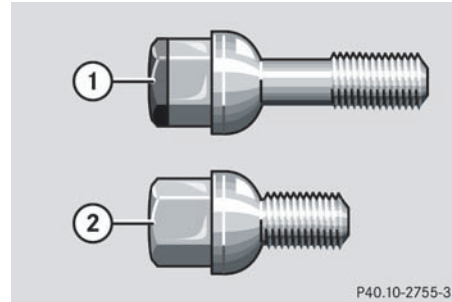

- 1 Wheel bolt for light alloy rims
- 2 Wheel bolt for Minispare wheel or other steel rims



Wheel bolts **2** must be used when mounting the Minispare wheel. The use of any wheel bolts other than wheel bolts **2** for the Minispare will physically damage the vehicle's brakes.

Warning!



Be sure to use the original length wheel bolts when remounting the original wheel after it has been repaired.

Unlocking/locking in an emergency

Unlocking/locking in an emergency

Unlocking the vehicle

Unlocking the driver's door

If you are unable to unlock the driver's door using the SmartKey, open the door using the mechanical key.

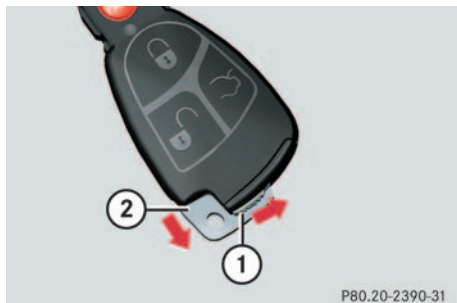

1 Mechanical key locking tab

2 Mechanical key

- ▶ Move locking tab **1** in direction of arrow and slide the mechanical key out of the housing.

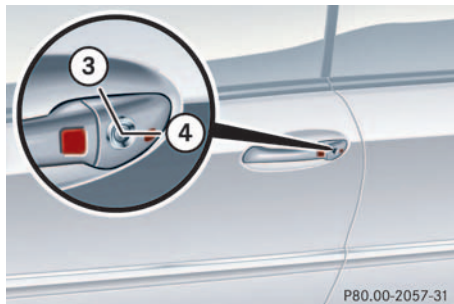



3 Unlocking

4 Locking

- ▶ Unlock the door with the mechanical key. To do so, push the mechanical key in the lock until it stops and turn it to the left.



Unlocking your vehicle with the mechanical key will trigger the anti-theft alarm system. To cancel the alarm, do one of the following:

- Press button  or  on the SmartKey.
- Insert the key in the starter switch.
- Press the KEYLESS-GO* start/stop button (▷ page 33).

Unlocking/locking in an emergency

Unlocking the trunk

If you are unable to unlock the trunk with the SmartKey, open the trunk with the mechanical key as follows:

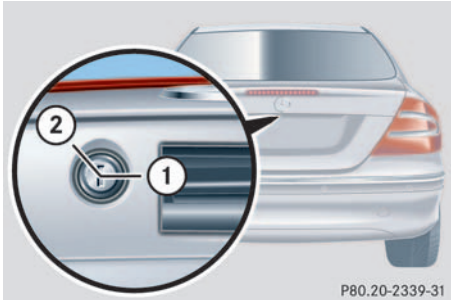

Trunk lid lock

- 1 Locking
- 2 Unlocking



- ▶ Insert the mechanical key into the trunk lid lock.
- ▶ Perform the following two steps simultaneously:
 - ▶ Turn the key counterclockwise to position **2**.
 - ▶ Pull the trunk lid handle and lift lid.



When opening the trunk completely, always make sure that there is sufficient overhead clearance.



Unlocking your vehicle with the mechanical key will trigger the anti-theft alarm system. To cancel the alarm, do one of the following:

- Press button  or  on the SmartKey.
- Insert the key in the starter switch.
- Press the KEYLESS-GO* start/stop button (▷ page 33).

Locking the vehicle

If you are unable to lock the vehicle with the SmartKey, lock it with the mechanical key as follows:

- ▶ Close the passenger door and the trunk lid.
- ▶ Press the central locking switch in the cockpit (▷ page 96).
- ▶ Check to see whether the locking knob on the passenger door is still visible. If necessary push it down manually.
- ▶ Lock the driver's door with the mechanical key.
- ▶ Lock the trunk lid if necessary with the mechanical key (▷ page 94).

Unlocking/locking in an emergency

Changing batteries

If the batteries in the SmartKey or the SmartKey with KEYLESS-GO* are discharged, the vehicle can no longer be locked or unlocked. It is recommended to have the batteries replaced at an authorized Mercedes-Benz Center.

Warning!



Keep the batteries out of reach of children.
If a battery is swallowed, seek medical help immediately.

Batteries contain materials that can harm the environment if disposed of improperly. Recycling of batteries is the preferred method of disposal. Many states require sellers of batteries to accept old batteries for recycling.



When changing batteries, always replace both batteries.

The required replacement batteries are available at any Mercedes-Benz Center.

SmartKey / SmartKey with KEYLESS-GO*

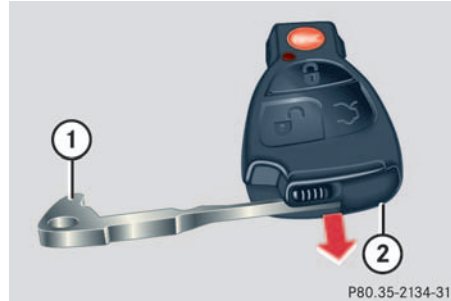

- 1 Mechanical key
- 2 Battery compartment

Replacement batteries: Lithium, type CR 2025 or equivalent.

- ▶ Remove mechanical key 1 (▷ page 310).
- ▶ Insert the mechanical key in side opening and push gray slide. The battery compartment is unlatched.
- ▶ Pull the battery compartment out of the key housing in direction of arrow.
- ▶ Remove the batteries.

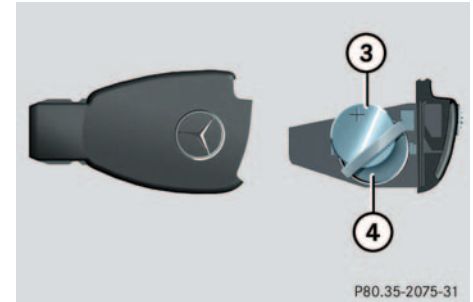

- 3 Battery
- 4 Contact spring

Unlocking/locking in an emergency

- ▶ Using a lint-free cloth, insert new batteries under the contact spring with the plus (+) side facing up.
- ▶ Return battery compartment into housing until it locks into place.

Fuel filler flap

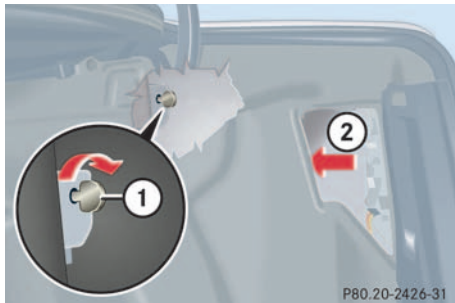

1 Release lever

- ▶ Remove the right side trim panel in the trunk.
- ▶ Reach inside in direction of arrow **2**.
- ▶ Turn release knob **1** clockwise as far as it will go.
The fuel filler flap can be opened.

Manually unlocking the transmission selector lever

In case of power failure, the transmission selector lever can be manually unlocked, e.g. to tow the vehicle.

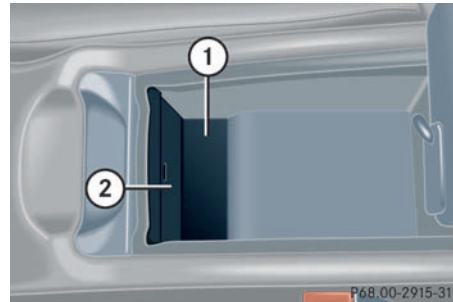

- ▶ Open the storage compartment in front of the center armrest.
- ▶ Take out cover **1**.
- ▶ Insert a pin into the opening of division **2** and pry the division out.

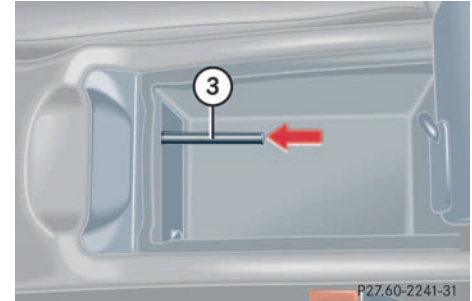

- ▶ Insert a tool **3** (e.g. screwdriver) into the opening.
- ▶ Perform the following two steps simultaneously:
 - ▶ Push pin **3** forward in the direction of the arrow.
 - ▶ Move selector lever from position **P**.
- ▶ Reinstall the division and cover after removing the tool from the opening.



The selector lever is locked again when moving it to position **P**.

Opening/closing in an emergency

Opening/closing in an emergency

Sliding/pop-up roof

The sliding/pop-up roof drive is located behind the lens of the interior overhead light.

You can open or close the sliding/pop-up roof manually should an electrical malfunction occur.



- ▶ Pry off lens **1** using a flat blade screwdriver.

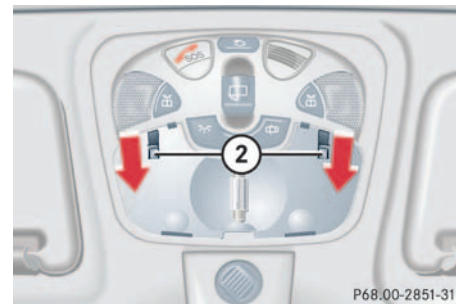

- ▶ Slide both locking tabs **2** in direction of arrow.
- ▶ Lower rear of cover and remove.
- ▶ Remove cover.



Do not disconnect electrical connectors.

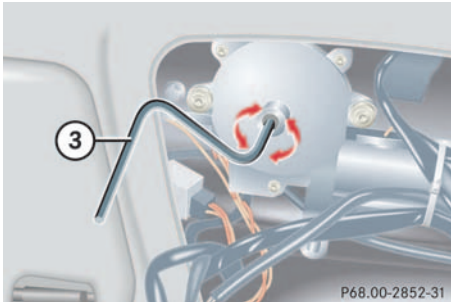

- ▶ Obtain crank **3**.
- ▶ Insert crank **3** through hole.
- ▶ Turn crank **3** clockwise to:
 - slide roof closed
 - raise roof at the rear
- ▶ Turn crank **3** counterclockwise to:
 - slide roof open
 - lower roof at the rear

The sliding/pop-up must be resynchronized after being operated manually (▷ page 315).

Synchronizing the sliding/pop-up roof

- ▶ Take the fuse for the sliding/pop-up roof out of the main fuse box (▷ page 337).
 - ▶ Reinsert the fuse.
 - ▶ Switch on the ignition.
 - ▶ Press the switch in the “raise” direction until the sliding/pop-up roof is fully raised at the rear.
- Hold the switch for approximately one second.
- The sliding/pop-up roof is adjusted.

Replacing bulbs

Replacing bulbs

Safe vehicle operation depends on proper exterior lighting and signaling. It is therefore essential that all bulbs and lamp assemblies are in good working order at all times.

Correct headlamp adjustment is extremely important. Have headlamps checked and readjusted at regular intervals and when a bulb has been replaced. See your authorized Mercedes-Benz Center for headlamp adjustment.



If the headlamps are fogged up on the inside as a result of high humidity, driving the vehicle a distance should clear up the fogging.



Backup bulbs will be brought into use when the following lamps malfunction:

- Turn signal lamps
- Brake lamps
- Parking lamps
- Tail lamps

Bulbs

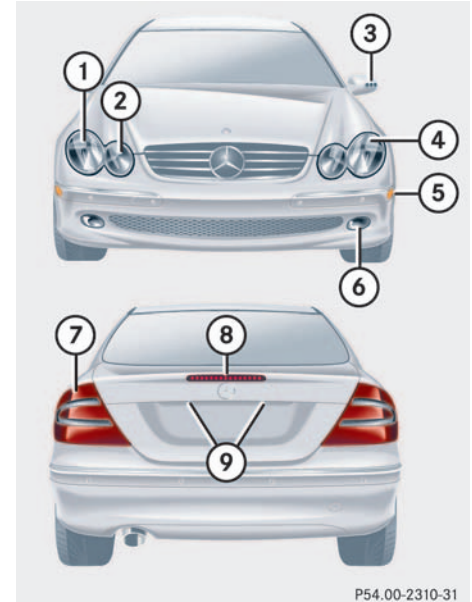

P54.00-2310-31

Front lamps

Lamp	Type
1 Low beam ¹	H7 (55 W) Bi-Xenon* D2S-35 W
2 High beam	H7 (55 W)
Parking and standing lamps	W 5 W
3 Additional turn signal lamps	LED
4 Turn signal lamp	1156 NA
5 Side marker lamp	W 5 W
6 Fog lamp	HB4/9006 (55 W)

¹ Vehicles with Bi-Xenon headlamps* do not replace the Bi-Xenon bulbs yourself.

Rear lamps

Lamp	Type
7 Rear fog lamp, driver's side	P 21/4 W
Turn signal lamp	P 21 W
Brake lamp	P 21 W
Backup lamp	P 21 W
Tail, parking and standing lamp, side marker	P 21/4 W W 5 W
8 High mounted brake lamp	LED
9 License plate lamps	C 5 W

Notes on bulb replacement

Warning!



Keep bulbs out of reach of children.

Bulbs and bulb sockets can be very hot. Allow the lamp to cool down before changing a bulb.

Halogen lamps contain pressurized gas. A bulb can explode if you:

- touch or move it when hot
- drop the bulb
- scratch the bulb

Wear eye and hand protection.

Because of high voltage in xenon lamps, it is dangerous to replace the bulb or repair the lamp and its components. We recommend that you have such work done by a qualified technician.

Replacing bulbs

- Only use 12 volt bulbs of the same type and with the specified watt rating.
- Switch lights off before changing a bulb to prevent short circuits.
- Always use a clean lint-free cloth when handling bulbs.
- Your hands should be dry and free of oil and grease.
- If the newly installed bulb does not light up, visit an authorized Mercedes-Benz Center.
- Have the LEDs and bulbs for the following lamps replaced by an authorized Mercedes-Benz Center.
 - Additional turn signal lamps in the exterior rear view mirrors
 - High mounted brake lamp
 - Bi-Xenon* lamps
 - Front fog lamps

Replacing bulbs for front lamps

Front lamps halogen-type

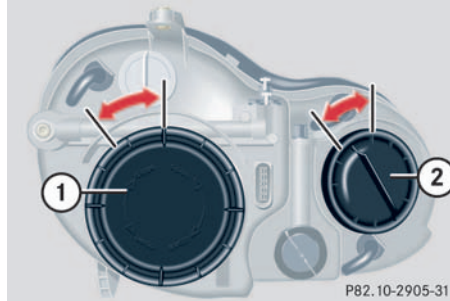

- 1 Housing cover for low beam lamp
- 2 Housing cover for high beam lamp

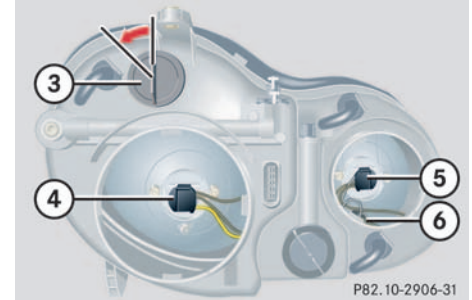

- 3 Bulb socket for turn signal lamp
- 4 Low beam bulb
- 5 High beam bulb
- 6 Parking and standing lamp

Low beam and high beam bulb

- ▶ Switch off the lights.
- ▶ Open the hood (▷ page 253).
- ▶ Turn housing cover **1** or **2** counterclockwise and remove.
- ▶ Turn bulb holder **4** or **5** with the bulb counterclockwise and remove.
- ▶ Press the bulb backwards and turn counterclockwise out of the bulb holder.
- ▶ Press the new bulb into the holder and twist it clockwise.
- ▶ Place the bulb holder back into the lamp and turn it clockwise.
- ▶ Place the corresponding housing covers back on and turn them clockwise.

Front turn signal lamp bulb

- ▶ Switch off the lights.
- ▶ Open the hood (▷ page 253).
- ▶ Twist bulb socket **3** counterclockwise and pull out.
- ▶ Push bulb into socket, turn counterclockwise and remove.
- ▶ Insert new bulb in socket, push in and twist clockwise.
- ▶ Reinsert bulb socket in lamp and twist clockwise.

Parking and standing lamp bulb

- ▶ Switch off the lights.
- ▶ Open the hood (▷ page 253).
- ▶ Turn housing cover **2** counterclockwise and remove.
- ▶ Pull out the bulb socket with the bulb.
- ▶ Pull the bulb out of the bulb socket.
- ▶ Insert a new bulb in the socket.
- ▶ Reinstall the bulb socket.
- ▶ Align housing cover and click into place.

Replacing bulbs

Front lamps Bi-Xenon* -type

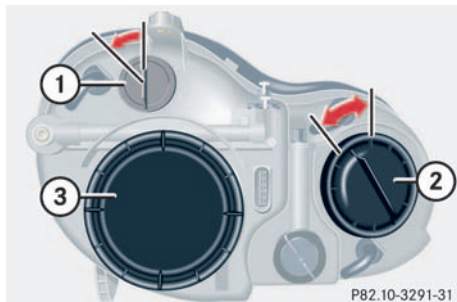

- 1 Bulb socket for turn signal lamp
- 2 Housing cover for high beam lamp
- 3 Housing cover for Bi-Xenon* lamp

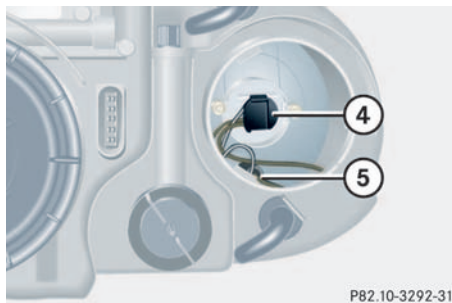

- 4 High beam bulb
- 5 Parking and standing lamp

Warning!



Do not remove the cover **3** for the Bi-Xenon* headlamp. Because of high voltage in xenon lamps, it is dangerous to replace the bulb or repair the lamp and its components. We recommend that you have such work done by a qualified technician.

High beam bulb

- ▶ Switch off the lights.
- ▶ Open the hood (▷ page 253).
- ▶ Turn housing cover **2** counterclockwise and remove.
- ▶ Turn bulb holder **4** with the bulb counterclockwise and remove.
- ▶ Press the bulb backwards and turn counterclockwise out of the bulb holder.
- ▶ Press the new bulb into the holder and twist it clockwise.
- ▶ Place the bulb holder back into the lamp and turn it clockwise.
- ▶ Place the housing cover **2** back on and turn them clockwise.

Front turn signal lamp bulb

- ▶ Switch off the lights.
- ▶ Open the hood (▷ page 253).
- ▶ Twist bulb socket **1** counterclockwise and pull out.
- ▶ Push bulb into socket, turn counterclockwise and remove.
- ▶ Insert new bulb in socket, push in and twist clockwise.
- ▶ Reinsert bulb socket in lamp and twist clockwise.

Parking and standing lamp bulb

- ▶ Switch off the lights.
- ▶ Open the hood (▷ page 253).
- ▶ Turn housing cover **2** counterclockwise and remove.
- ▶ Pull out the bulb socket with the bulb.
- ▶ Pull the bulb out of the bulb socket.
- ▶ Insert a new bulb in the socket.
- ▶ Reinstall the bulb socket.
- ▶ Align housing cover and click into place.

Side marker lamp bulb

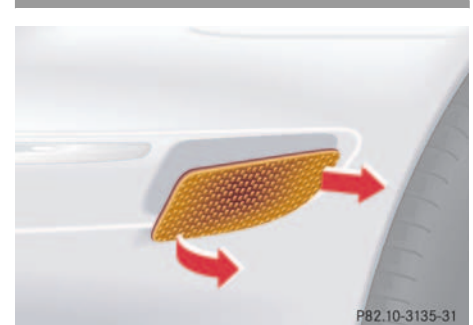

- ▶ Switch off the lights.
- ▶ Carefully slide lamp towards rear.
- ▶ Remove front end first.
- ▶ Twist bulb socket counterclockwise and pull out.
- ▶ Pull bulb out of the bulb socket.
- ▶ Insert new bulb in socket.
- ▶ Reinstall bulb socket, push in and twist clockwise.
- ▶ To reinstall lamp, set rear end in bumper and let front end snap into place.

Replacing bulbs

Replacing bulbs for rear lamps

Tail lamp assemblies

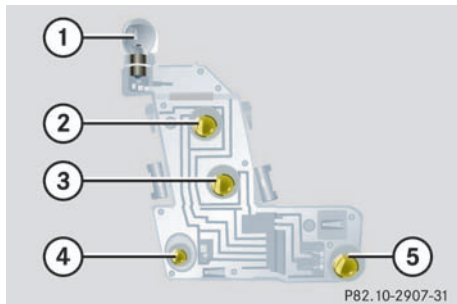

- 1 Brake lamp
- 2 Turn signal lamp
- 3 Backup lamp
- 4 Standing and side marker lamp
- 5 Rear fog lamp (driver's side)/tail

- ▶ Switch off the lights.
- ▶ Open trunk.
- ▶ Swing the trim panel covering the corresponding rear lights to the side.
- ▶ Squeeze tabs together and remove the bulb holder with the bulb.

- ▶ Twist bulb counterclockwise and pull out of bulb holder.
- ▶ Insert new bulb into the holder and turn it clockwise.
- ▶ Reinstall bulb holder. The tabs must audibly click.
- ▶ Close trim panel.
- ▶ Place the housing cover back on so that its tabs click in place.

License plate lamp

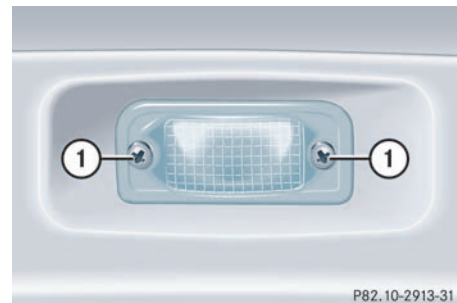

1 Screws

- ▶ Switch off the lights.
- ▶ Loosen both screws 1 and remove lamp.
- ▶ Replace the tubular lamp and reinstall lamp.
- ▶ Retighten the screws.

Replacing wiper blades

Warning!



For safety reasons, remove key from starter switch before replacing a wiper blade, otherwise the motor could suddenly turn on and cause injury.

Removing

- ▶ Fold the wiper arm forward.

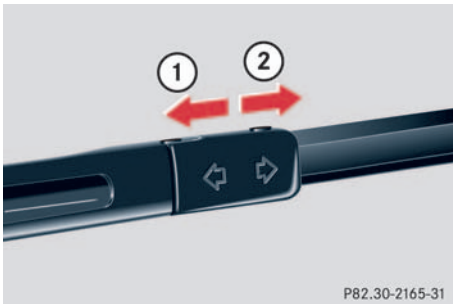

- 1 Lock
- 2 Unlock

- ▶ Pull the tab in the direction of arrow 2 and remove windshield wiper.

Installing

- ▶ Slide the wiper blade into the cutout on the wiper arm.
- ▶ Slide the tab back in the direction of arrow 1 until it audibly engages.
- ▶ Fold the wiper arm backward to rest on the windshield.



Never open the hood when the wiper arm is folded forward.

Do not allow the wiper arms to contact the windshield glass without a wiper blade inserted.

Make certain that the wiper blades are properly installed. Improperly installed wiper blades may cause windshield damage.

For your convenience, we recommend that you have this work carried out by an authorized Mercedes-Benz Center.

Flat tire

Flat tire

Preparing the vehicle

- ▶ Park the vehicle as far as possible from moving traffic on a hard surface.
- ▶ Turn on the hazard warning flashers.
- ▶ Engage the steering wheel lock in the straight ahead position and set the parking brake.
- ▶ Move the selector lever to **P**.
- ▶ Have any passenger exit the vehicle at a safe distance from the roadway.

Mounting the Minispare wheel

Warning!



The dimensions of the Minispare wheel are different from those of the road wheels. As a result, the vehicle handling characteristics change when driving with a Minispare wheel mounted.

The spare wheel should only be used temporarily, and should be replaced with a regular road wheel as quickly as possible.

In case of a flat tire, you may temporarily use the spare wheel when observing the following restrictions:

- Do not exceed a vehicle speed of 50 mph (80 km/h).
- Drive to the nearest tire repair facility to have the flat tire repaired or replaced as appropriate.
- Do not operate the vehicle with more than one spare wheel mounted.

Preparing the vehicle

Prepare the vehicle as described on (▷ page 324).

- ▶ Take the wheel wrench and the jack out of the trunk (▷ page 307).
- ▶ Take the Minispare wheel out of the trunk (▷ page 307).

Lifting the vehicle

- ▶ Prevent the vehicle from rolling away by blocking wheels with wheel chocks (not included) or other sizable objects.

When changing wheel on a level surface:

- ▶ Place one chock in front of and one behind the wheel that is diagonally opposite to the wheel being changed.

When changing wheel on a hill:

- ▶ Place chocks on the downhill side blocking both wheels of the other axle.▷▷

Warning!



The jack is designed exclusively for jacking up the vehicle at the jack take-up brackets built into both sides of the vehicle. To help avoid personal injury, use the jack only to lift the vehicle during a wheel change. Never get beneath the vehicle while it is supported by the jack. Keep hands and feet away from the area under the lifted vehicle. Always firmly set parking brake and block wheels before raising vehicle with jack.

Do not disengage parking brake while the vehicle is raised. Be certain that the jack is always vertical (plumb line) when in use, especially on hills. Always try to use the jack on a level surface. Make sure that the jack arm is fully seated in the jack take-up bracket. Always lower the vehicle onto sufficient capacity jackstands before working under the vehicle.

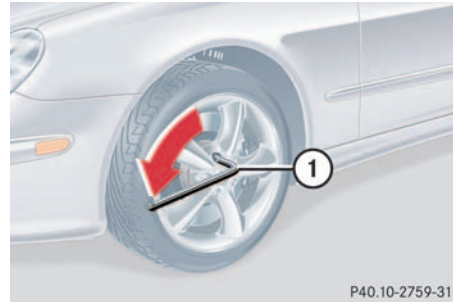

1 Wheel wrench

- ▶ On wheel to be changed, loosen but do not yet remove the wheel bolts (approximately one full turn with wrench).

The jack take-up brackets are located directly behind the front wheel housings and in front of the rear wheel housings.

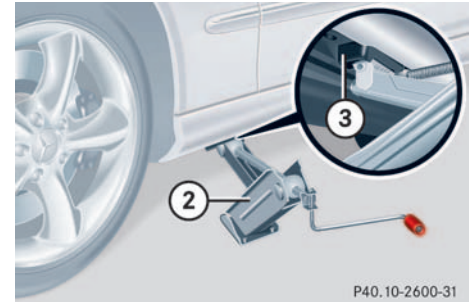

2 Jack

3 Take-up bracket

- ▶ Place jack **2** on firm ground.
- ▶ Position jack **2** under take-up bracket **3** so that it is always vertical (plumb-line) as seen from the side, even if the vehicle is parked on an incline.

Flat tire

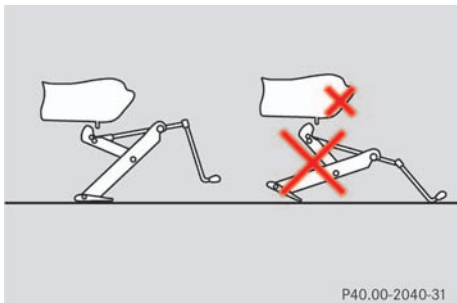

- ▶ Jack up the vehicle until the wheel is a maximum of 1.2 in (3 cm) from the ground. Never start engine while vehicle is raised.

Warning!



The jack is intended only for lifting the vehicle briefly for wheel changes. It is not suited for performing maintenance work under the vehicle.

- Never start the engine when the vehicle is raised.
- Never lie down under the raised vehicle.

Removing the wheel



4 Alignment bolt

- ▶ Unscrew upper-most wheel bolt and remove.
- ▶ Replace this wheel bolt with alignment bolt 4 supplied in the tool kit.
- ▶ Remove the remaining bolts.



Do not place wheel bolts in sand or dirt. This could result in damage to the bolt and wheel hub threads.

- ▶ Remove the wheel.

Mounting the new wheel

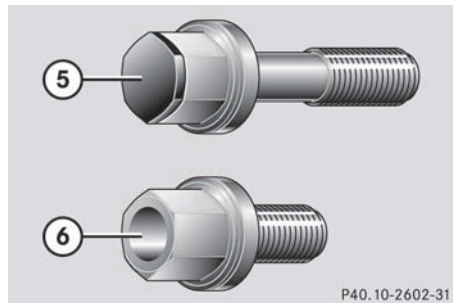

5 Wheel bolt for light alloy rims

6 Wheel bolt for Minispare wheel or other steel rims



Wheel bolts 6 must be used when mounting the Minispare wheel. The use of any wheel bolts other than wheel bolts 6 for the Minispare will physically damage the vehicle's brakes.

- ▶ Clean contact surfaces of wheel and wheel hub.



To avoid paint damage, place wheel flat against hub and hold it there while installing first wheel bolt.

Warning!



Always replace wheel bolts that are damaged or rusted.

Never apply oil or grease to wheel bolts.

Damaged wheel hub threads should be repaired immediately. Do not continue to drive under these circumstances! Contact an authorized Mercedes-Benz Center or call Roadside Assistance.

Incorrect mounting bolts or improperly tightened mounting bolts can cause the wheel to come off. This could cause an accident. Be sure to use the correct mounting bolts.

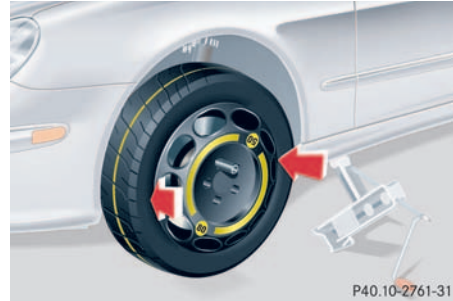

- ▶ Guide the spare wheel onto the alignment bolt and push it on.
- ▶ Insert wheel bolts and tighten them slightly.

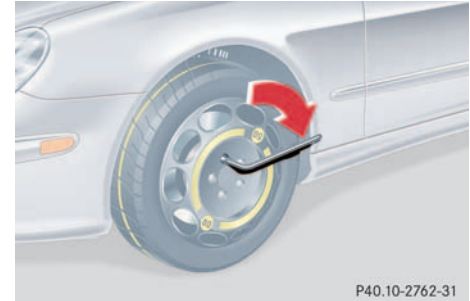

- ▶ Unscrew the alignment bolt, install last wheel bolt and tighten slightly.

Warning!



Only use genuine equipment Mercedes-Benz wheel bolts. They are identified by the Mercedes star. Other wheel bolts may come loose.

Do not tighten the wheel bolts when the vehicle is raised. Otherwise the vehicle could tip over.



Flat tire

Lowering the vehicle

- ▶ Lower vehicle by turning crank counterclockwise until the full weight of the vehicle is resting on the ground.
- ▶ Remove the jack.

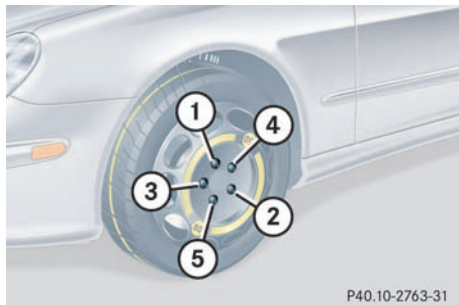

1-5 Wheel bolts

- ▶ Tighten the five wheel bolts evenly, following the diagonal sequence illustrated (1 to 5), until all bolts are tight. Observe a tightening torque of 80 ft lb (110 Nm).

Warning!



Have the tightening torque checked after changing a wheel. The wheels could come loose if they are not tightened to a torque of 80 ft lb (110 Nm).

- ▶ Before storing the jack in the trunk, it should be fully collapsed, with handle folded in.

Battery

The battery is located in the engine compartment on the right hand side.

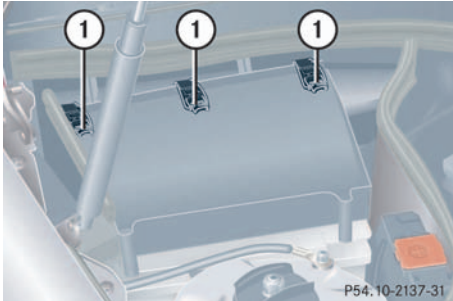

Removal of filter box:

- ▶ Release the three clamps **1**.
- ▶ Remove filter box.

Installation of filter box:

- ▶ Insert filter box properly.
- ▶ Secure it with the three clamps **1**.

Warning!



Failure to follow these instructions can result in severe injury or death.

Never lean over batteries while connecting, you might get injured.

Battery fluid contains sulfuric acid. Do not allow this fluid to come in contact with eyes, skin or clothing. In case it does, immediately flush affected area with water and seek medical help if necessary.

A battery will also produce hydrogen gas, which is flammable and explosive. Keep flames or sparks away from battery, avoid improper connection of jumper cables, smoking etc.



Never loosen or detach battery terminal clamps while the engine is running or the key is in the starter switch. Otherwise the alternator and other electronic components could be severely damaged.

Have the battery checked regularly by an authorized Mercedes-Benz Center.

Refer to Service Booklet for maintenance intervals or contact your authorized Mercedes-Benz Center for further information.

Warning!



Do not place metal objects on the battery as this could result in a short circuit.

Use leak-proof battery only to avoid the risk of acid burns in the event of an accident.

Battery

Warning!



With a disconnected battery

- you will no longer be able to turn the key in the starter switch and pressing the KEYLESS-GO* start/stop button (if so equipped) on the selector lever will have no effect
- the selector lever will remain locked in position **P**

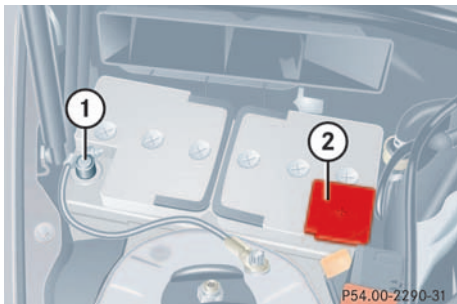

1 Negative terminal

2 Cover over positive terminal

Disconnecting the battery

- ▶ Turn off all electrical consumers.
- ▶ Open the hood (> page 253).
- ▶ Remove the filter box.
- ▶ Disconnect battery negative lead **1**.
- ▶ Remove cover **2** from the positive terminal.
- ▶ Disconnect the battery positive lead.

Removing the batteries

- ▶ Remove the screw securing the battery.
- ▶ Remove the battery support and bracket. Take out the battery.

Charging and reinstalling batteries

- ▶ Charge battery in accordance with the instructions of the battery charger manufacturer.
- ▶ Reinstall the charged battery. Follow the previously described steps in reverse order.

Warning!



Never charge a battery while still installed in the vehicle. Gases may escape during charging and cause explosions that may result in paint damage, corrosion or personal injury.

Reconnecting the batteries

- ▶ Turn off all electrical consumers.
- ▶ Connect the positive lead and fasten its cover **2**.
- ▶ Connect the negative lead **1**.



NEVER invert the terminal connections.

- ▶ Reinstall the filter box.



The battery, its filler caps and the vent tube must always be securely installed when the vehicle is in operation.



The following procedures must be carried out following any interruption of battery power (e.g. due to reconnecting):

- Set the clock (▷ page 128) (vehicles with COMAND*: see COMAND operator's manual).
- Resynchronize the ESP (▷ page 294).
- Resynchronize side windows (▷ page 189).
- Resynchronize sliding/pop-up roof (▷ page 315).

Batteries contain materials that can harm the environment if disposed of improperly. Large 12-volt storage batteries contain lead. Recycling of batteries is the preferred method of disposal. Many states require sellers of batteries to accept old batteries for recycling.

Jump starting

Jump starting

Warning!



Failure to follow these directions will cause damage to the electronic components, and can lead to a battery explosion and severe injury or death.

Never lean over batteries while connecting or jump starting, you might get injured.

Battery fluid contains sulfuric acid. Do not allow this fluid to come in contact with eyes, skin or clothing. In case it does, immediately flush affected area with water, and seek medical help if necessary.

A battery will also produce hydrogen gas, which is flammable and very explosive. Keep flames or sparks away from battery, avoid improper connection of jumper cables, smoking etc.

Attempting to jump start a frozen battery can result in it exploding, causing personal injury.

Read all instructions before proceeding.

If the battery is discharged, the engine can be started with jumper cables and the battery of another vehicle. Observe the following:

- Jump starting should only be performed when the engine and catalytic converter are cold.
- Do not start the engine if the battery is frozen. Let the battery thaw out first.
- Only jump start from batteries with the same voltage rating (12V). Jump starting with a more powerful battery could damage the vehicle's electrical system, which will not be covered by the Mercedes-Benz Limited Warranty.
- Only use jumper cables with sufficient cross-section and insulated terminal clamps.



Jump starting may only be performed on the battery installed in the engine compartment.

Avoid repeated and lengthy starting attempts.

Do not attempt to start the engine using a battery quick charge unit.

If the engine does not run after several unsuccessful starting attempts, have it checked at the nearest authorized Mercedes-Benz Center.

Excessive unburned fuel generated by repeated failed starting attempts may damage the catalytic converter and may present a fire risk.

Make sure the jumper cables do not have loose or missing insulation.

Make sure the cable clamps do not touch any other metal part while the other end is still attached to a battery.

Warning!



Keep flames or sparks away from battery.
Do not smoke.

Observe all safety instructions and precautions when handling automotive batteries (▷ page 258).

The battery is located in the engine compartment on the right hand side. For jump starting use the terminals in front of the battery.

- ▶ Make sure that the two vehicles do not touch.
- ▶ Turn off all electrical consumers.
- ▶ Apply parking brake.
- ▶ Shift selector lever to position **P**.

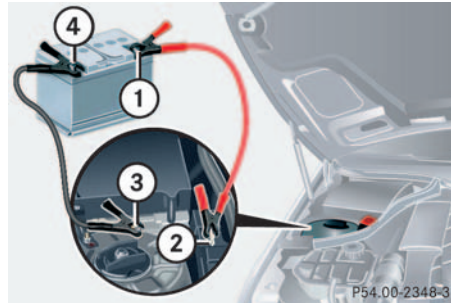

- 1 Positive terminal of charged battery
 - 2 Positive under hood terminal in front of discharged battery
 - 3 Negative under hood terminal in front of discharged battery
 - 4 Negative terminal of charged battery
- ▶ Connect the positive terminal **1** of the charged battery with the under hood terminal **2** in front of the discharged battery with the jumper cable. Clamp cable to charged battery **1** first.
 - ▶ Let the engine of the assisting vehicle run at idle speed.

- ▶ Connect the negative terminal **4** of the charged battery with the under hood terminal **3** in front of the discharged battery with the jumper cable. Clamp cable to charged battery **4** first.
- ▶ Start the engine of the disabled vehicle.

Now you can again turn on the electrical consumers. Do not turn on the lights under any circumstances.

- ▶ Remove the jumper cables first from the negative terminals **3** and **4** and then from the positive terminals **1** and **2**.
- ▶ Have the battery checked at the nearest authorized Mercedes-Benz Center.



The vehicle cannot be started via tow-start.

Towing the vehicle

Towing the vehicle

Towing the vehicle

Mercedes-Benz recommends that the vehicle be transported with all wheels off the ground using flatbed or appropriate wheel lift/dolly equipment.



Use flatbed or wheel lift/dolly equipment with key in starter switch turned to position **0**.

Do not tow with sling-type equipment. Towing with sling-type equipment over bumpy roads will damage radiator and supports.

To prevent damage during transport, do not tie down vehicle by its chassis or suspension parts.

Switch off the tow-away alarm (▷ page 81) and the automatic central locking (▷ page 133).

When circumstances do not permit the recommended towing methods, the vehicle may be towed with all wheels on the ground or front wheels raised only so far as necessary to have the vehicle moved to a safe location where the recommended towing methods can be employed.



If the vehicle is towed with the front axle raised, the engine must be shut off (key in starter switch position **0** or **1**). Otherwise, the ESP will immediately be engaged and will apply the rear wheel brakes.

When towing the vehicle with all wheels on the ground, the selector lever must be in position **N** and the key must be in starter switch position **2**.

When towing the vehicle with all wheels on the ground or the front axle raised, the vehicle may be towed only for distances up to 30 miles (50 km) and at a speed not to exceed 30 mph (50 km/h).



To be certain to avoid a possibility of damage to the transmission, however, we recommend the drive shaft be disconnected at the rear axle drive flange for any towing beyond a short tow to a nearby garage.

Warning!

Prior to towing the vehicle with all wheels on the ground, make certain that the key is in starter switch position **2**.

If the key is left in starter switch position **0** for an extended period of time, it can no longer be turned in the switch. In this case, the steering is locked. To unlock, remove key from starter switch and reinsert.

If circumstances require towing the vehicle with all wheels on the ground, always tow with a tow bar if:

- the engine will not run
- there is a malfunction in the power supply or in the vehicle's electrical system

as that will be necessary to adequately control the towed vehicle.

Warning!

With the engine not running, there is no power assistance for the braking and steering systems. In this case, it is important to keep in mind that a considerably higher degree of effort is necessary to brake and steer the vehicle. Adapt your driving accordingly.



To signal turns while being towed with the hazard warning flasher in use, turn key in starter switch to position **2** and activate the combination switch for the left or right turn signal in the usual manner – only the selected turn signal will operate.

Upon canceling the turn signal, the hazard warning flasher will operate again.

Towing the vehicle



When towing the vehicle with all wheels on the ground, please note the following:

With the automatic central locking activated and the key in starter switch position **2**, or KEYLESS-GO* start/stop button (if so equipped) in position **2**, the vehicle doors lock if the left front wheel as well as the right rear wheel are turning at vehicle speeds of approx. 9 mph (15 km/h) or more.

Switch off the tow-away alarm (▷ page 81).

To prevent the vehicle door locks from locking, deactivate the automatic central locking (▷ page 133).

Towing of the vehicle should only be done using the properly installed towing eye bolt. Never attach tow cable, tow rope or tow rod to the vehicle chassis, frame or suspension parts.



The selector lever will remain locked in position **P** and the key will not turn in the starter switch if the battery is disconnected or discharged. See notes on the battery (▷ page 329) or on jump starting (▷ page 332).

Installing towing eye bolt



1 Cover on right side of front bumper

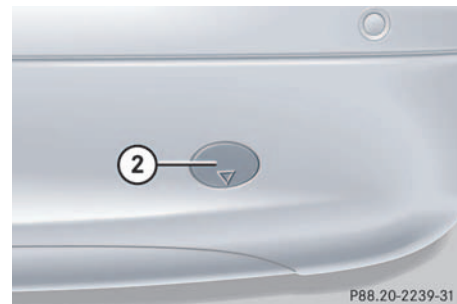

2 Cover on right side of rear bumper

To remove cover:

- ▶ Press mark on cover in direction of arrow.
- ▶ Lift cover off to reveal threaded hole for towing eye bolt.

The towing eye bolt is supplied with the tool kit (located in the compartment underneath the trunk floor).

- ▶ Screw towing eye bolt to its stop and tighten with lug wrench.

To reinstall cover:

- ▶ Fit cover and snap into place.

Fuses



Only install fuses that have been tested and approved by Mercedes-Benz and that have the specified amperage rating.

Never attempt to repair or bridge a blown fuse. Have the cause determined and remedied by an authorized Mercedes-Benz Center.

Fuse box in passenger compartment



Opening

- ▶ Pull cover away from fuse box **1** (arrow).
- ▶ Remove cover rearward.

Closing

- ▶ Attach the cover in the front.
- ▶ Fold the cover in until it engages.

Fuse chart

The fuse chart is found in the fuse box in the passenger compartment. The amperages of the fuses are also given there.

Fuse box in engine compartment

The fuse box is located in the engine compartment on the left-hand side.

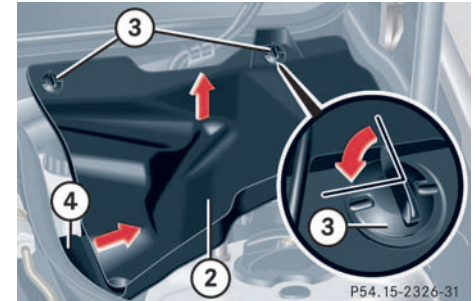

- 2** Cover
- 3** Screw
- 4** Retainer

Removing/installing cover

- ▶ Twist screws **3** 90° counterclockwise.
- ▶ Pull up cover **2**.
- ▶ Slide out retainer **4** and remove cover by pulling towards front.
- ▶ Install cover **2** in reverse order.

Fuses

Opening fuse box

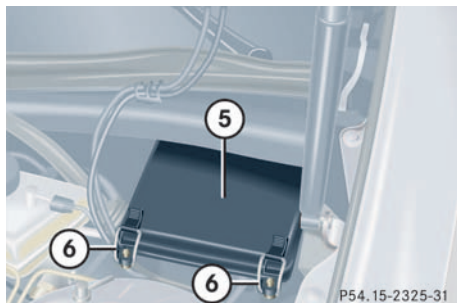

5 Fuse box cover

6 Clamps

- ▶ Release clamps **6**.
- ▶ Remove cover **5**.

Closing fuse box

- ▶ Ensure that the sealing rubber is properly positioned.
- ▶ Press the cover down and secure with clamps **6**.

Auxiliary fuse box in trunk

The auxiliary fuse box is located in the trunk on the left hand side.

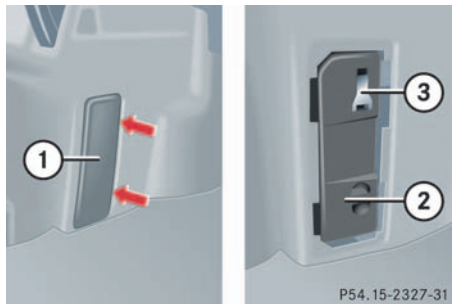

1 Trim

2 Cover

3 Spare extractor

Opening auxiliary fuse box

- ▶ Pull off trim **1**.
- ▶ Remove cover **2**.

Closing auxiliary fuse box

- ▶ Place cover **2** back on.
- ▶ Press trim **1** back into place.

Spare fuses

Spare fuses are found in the vehicle tool kit in the cargo area.

Spare extractor

The fuse extractor is located in the cover of the auxiliary fuse box in the trunk.

Technical data

Spare parts service

Warranty coverage

Identification labels

Layout of poly-V-belt drive

Engine

Rims and tires

Electrical system

Main dimensions

Weights

Fuels, coolants, lubricants, etc.

Consumer information



Spare parts service

The “Technical data” section provides the necessary technical data for your vehicle.

Spare parts service

All authorized Mercedes-Benz Centers maintain a stock of original spare parts required for maintenance and repair work. In addition, strategically located parts distribution centers provide quick and reliable parts service.

More than 300 000 different spare parts for Mercedes-Benz models are available.

Mercedes-Benz original spare parts are subjected to stringent quality inspections. Each part has been specifically developed, manufactured or selected for and adapted to Mercedes-Benz vehicles.

Therefore, Mercedes-Benz original spare parts should be installed.



The use of non-genuine parts and accessories not authorized by Mercedes-Benz could damage the vehicle, which is not covered by the Mercedes-Benz Limited Warranty, or could compromise the vehicle’s durability or safety.

Warranty coverage

Your vehicle is covered under the terms of the warranties printed in the Service and Warranty Information booklet. Your authorized Mercedes-Benz Center will exchange or repair any defective parts originally installed in the vehicle in accordance with the terms of the following warranties:

- New Vehicle Limited Warranty
- Emission System Warranty
- Emission Performance Warranty
- California, Maine, Massachusetts, and Vermont Emission Control Systems Warranty

Replacement parts and accessories are covered by the Mercedes-Benz Spare Parts and Accessories warranties, copies of which are available at any Mercedes-Benz Center.

Loss of Service and Warranty Information Booklet

Should you lose your Service and Warranty Information booklet, have your authorized Mercedes-Benz Center arrange for a replacement. It will be mailed to you.

Identification labels

Identification labels

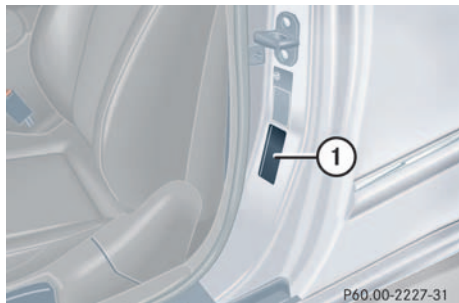

1 Certification label

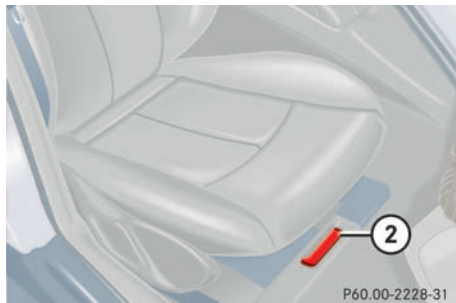

2 Vehicle Identification Number (VIN)

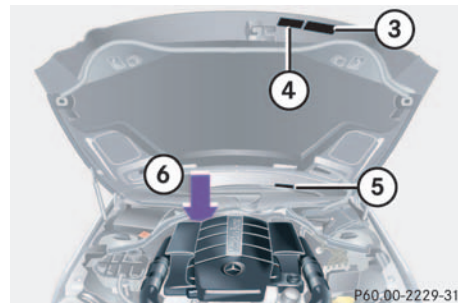

- 3 Information label, California version
Vacuum line routing for emission control system
- 4 Emission control label
- 5 VIN, visible (lower edge of windshield)
- 6 Engine number (engraved on engine)

When ordering spare parts, please specify vehicle identification and engine numbers.

Layout of poly-V-belt drive

CLK 320 / CLK 500 / CLK 55 AMG

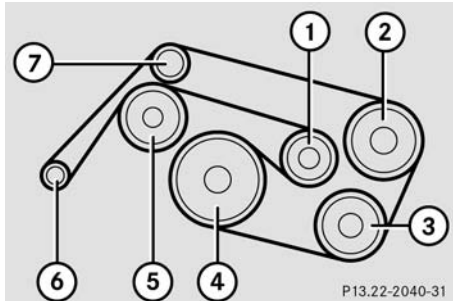

- 1 Automatic belt tensioner
- 2 Power steering pump
- 3 Air conditioning compressor
- 4 Crankshaft
- 5 Coolant pump
- 6 Generator (alternator)
- 7 Idler pulley

Engine
Engine

Model	CLK 320 (209.365 ¹)	CLK 500 (209.375 ¹)	CLK 55 AMG (209.376) ¹
Engine	112	113	113
Mode of operation	4-stroke engine, gasoline injection	4-stroke engine, gasoline injection	4-stroke engine, gasoline injection
No. of cylinders	6	8	8
Bore	3.54 in (89.90 mm)	3.82 in (97.00 mm)	3.82 in (97.00 mm)
Stroke	3.31 in (84.00 mm)	3.31 in (84.00 mm)	3.60 in (92.00 mm)
Total piston displacement	195.2 cu.in. (3199 cm ³)	302.9 cu.in. (4966 cm ³)	331.8 cu.in. (5439 cm ³)
Compression ratio	10:1	10:1	11:1
Output acc. to SAE J 1349	215 hp / 5700 rpm (160 kW / 5700 rpm)	302 hp / 5600 rpm (225 kW / 5600 rpm)	362 hp / 5750 rpm (270 kW / 5750 rpm)
Maximum torque acc. to SAE J 1349	229 ft.lb / 3000 rpm (310 Nm / 3000 rpm)	339 ft.lb / 2700 rpm (460 Nm / 2700 rpm)	369 ft.lb / 4000 rpm (510 Nm / 4000 rpm)
Maximum engine speed	6000 rpm	6000 rpm	6700 rpm
Firing order	1-4-3-6-2-5	1-5-4-2-6-3-7-8	1-5-4-2-6-3-7-8
Poly-V-belt	7 ft 10 in (2390 mm)	7 ft 10 in (2390 mm)	7 ft 10 in (2390 mm)

¹ The quoted data apply only to the standard vehicle. See an authorized Mercedes-Benz Center for the corresponding data of all special bodies and special equipment.

Rims and tires

Only use tires and rims which have been specifically developed for your vehicle and tested and approved by Mercedes-Benz. Other tires and rims can have detrimental effects, such as

- poor handling characteristics
- increased noise
- increased fuel consumption



Moreover, tires and rims not approved by Mercedes-Benz may, under load, exhibit dimensional variations and different tire deformation characteristics that could cause them to come into contact with the vehicle body or axle parts. Damage to the tires or the vehicle may be the result.



Further information on tires and rims is available at any authorized Mercedes-Benz Center. A tire inflation pressure table is located on the fuel filler cap of the vehicle. The tire pressure should be checked regularly and should only be adjusted on cold tires. Follow tire manufacturer's maintenance recommendation included with vehicle.

Same size tires

	CLK 320	CLK 500 / CLK 320 with Sport Package*	CLK 55 AMG
Rims (light alloy)	7J x 16 H2	7 ¹ / ₂ J x 17 H2	7 ¹ / ₂ J x 17 H2
Wheel offset	1.45 in (37 mm)	1.45 in (37 mm)	1.45 in (37 mm)
Winter tires (radial-ply tires)	205/55 R 16 91 H M+S	225/45 R 17 91 H M+S ¹	225 / 45 R17 91 H M+S ¹

¹ Must not be used with snow chains.

Rims and tires

Mixed size tires

	CLK 320	CLK 500 / CLK 320 with Sport Package*	CLK 55 AMG
Front axle:			
Rims (light alloy)	7 J x 16 H2	7 ¹ / ₂ J x 17 H2	7 ¹ / ₂ J x 17 EH2
Wheel offset	1.45 in (37 mm)	1.45 in (37 mm)	1.45 in (37 mm)
Summer tires (radial-ply tires)	205/55 R 16 91 H	225/45 R 17 91 W	225/45 R 17 91 Y
Rear axle:			
Rims (light alloy)	8 J x 16 H2	8 ¹ / ₂ J x 17 H2	8 ¹ / ₂ J x 17 EH2
Wheel offset	1.26 in (32 mm)	1.18 in (30 mm)	1.18 in (30 mm)
Summer tires (radial-ply tires)	225/50 R 16 92 H ¹	245/40 R 17 91 W ¹	245/40 R 17 91 Y ¹

¹ Must not be used with snow chains.

Minispare wheel

	CLK 320	CLK 500 / CLK 320 with Sport Package*	CLK 55 AMG
Rim	3.5 B x 16 H2	3.5 B x 17 H2	3.5 B x 17 H2
Wheel offset	0.67 in (17 mm)	0.67 in (17 mm)	0.67 in (17 mm)
Tire	T 125/90 R 16 98 M ¹	T 125/80 R 17 99 M ¹	T 125/90 R 17 99 M ¹

¹ Must not be used with snow chains.

Electrical system**Electrical system**

Model	CLK 320	CLK 500	CLK 55 AMG
Generator (alternator)	14 V/120 A	14 V/150 A	14 V/150 A
Starter motor	14 V/1.4 KW	14 V/1.7 KW	14 V/1.7 KW
Battery	12 V/100 Ah	12 V/100 Ah	12 V/100 Ah
Spark plugs	Bosch F8 DPP 332U NGK PFR 5R-11	Bosch F8 DPP 332U NGK PFR 5R-11	NGK ILFR 6A
Electrode gap	0.039 in (1.00 mm)	0.039 in (1.00 mm)	0.031 in (0.8 mm)
Tightening torque	18.5 - 22 ft.lb (25 - 30 Nm)	18.5 - 22 ft.lb (25 - 30 Nm)	18.5 - 22 ft.lb (25 - 30 Nm)

Main dimensions

Model	CLK 320	CLK 500	CLK 55 AMG
Overall vehicle length	182.6 in (4638 mm)	182.6 in (4638 mm)	182.6 in (4638 mm)
Overall vehicle width	68.5 in (1740 mm)	68.5 in (1740 mm)	68.5 in (1740 mm)
Overall vehicle height	55.4 in (1406 mm)	55.4 in (1408 mm)	55.4 in (1408 mm)
Wheelbase	106.9 in (2715 mm)	106.9 in (2715 mm)	106.9 in (2715 mm)
Track, front	58.8 in (1493 mm)	58.8 in (1493 mm)	58.8 in (1493 mm)
Track, rear	58.0 in (1474 mm)	58.0 in (1474 mm)	58.0 in (1474 mm)

Technical data

Weights

Weights

Roof load max.	220 lb (100 kg)
----------------	-----------------

Trunk load max.	220 lb (100 kg)
-----------------	-----------------

Fuels, coolants, lubricants, etc.

Fuels, coolants, lubricants, etc.

Capacities

Vehicle components and their respective lubricants must match. Therefore only use brands tested and recommended by us.

Please refer to the Factory Approved Service Products pamphlet, or inquire at your Mercedes-Benz Center.

	Model	Capacity	Fuels, coolants, lubricants, etc.
Engine with oil filter	CLK 320	8.5 US qt (8.0 l)	Recommended engine oils
	CLK 500	8.0 US qt (7.5 l)	
	CLK 55 AMG	9.0 US qt (8.5 l)	
Automatic transmission	CLK 320	8.0 US qt (7.5 l)	MB Automatic Transmission Oil ¹
	CLK 500	9.3 US qt (8.7 l)	
	CLK 55 AMG	9.3 US qt (8.7 l)	
Rear axle	CLK 320	1.28 US qt (1.2 l)	Hypoid gear oil SAE 85 W 90
	CLK 500	1.5 US qt (1.4 l)	
	CLK 55 AMG	1.5 US qt (1.4 l)	
Power steering		approx. 1.1 US qt (1.0 l)	MB Power Steering Fluid (Pentosin CHF 11S)
Front wheel hubs		approx. 3.0 oz (85 g) each	High temperature roller bearing grease
Brake system		0.64 US qt (0.6 l)	MB Brake Fluid (DOT 4+)

¹ MB part no. 001 989 21 03 10

Fuels, coolants, lubricants, etc.

	Model	Capacity	Fuels, coolants, lubricants, etc.
Cooling system	CLK 320 CLK 500 CLK 55 AMG	approx. 10.7 US qt (10 l) approx. 12.8 US qt (12 l) approx. 12.8 US qt (12 l)	MB 325.0 Anticorrosion/Antifreeze Agent
Fuel tank including a reserve of		16.35 US gal (62.0 l) 2.11 US gal (8.0 l)	Premium unleaded gasoline: Posted Octane 91 (Avg. of 96 RON / 86 MON)
Air conditioning system			R-134a refrigerant and special PAG lubricant oil (never R-12)
Windshield washer and headlamp cleaning system*:		6.4 US qt (6 l)	MB Windshield Washer Concentrate ¹

¹ Use MB Windshield Washer Concentrate “S” and water for temperatures above freezing or MB Windshield Washer Concentrate “S” and commercially available pre-mixed windshield washer solvent / antifreeze for temperatures below freezing. Follow suggested mixing ratios (▷ page 357).

Engine oils

Engine oils are specifically tested for their suitability in our engines. Therefore, only use engine oils recommended by Mercedes-Benz. Information on recommended brands is available in the Factory Approved Service Products pamphlet, or at your authorized Mercedes-Benz Center.

Please follow FSS recommendations for scheduled oil changes. Failure to do so could result in engine damage not covered by the Mercedes-Benz Limited Warranty.

Engine oil additives

Do not blend oil additives with engine oil. They may be harmful to the engine operation.

Damage or malfunctions resulting from blending oil additives are not covered by the Mercedes-Benz Limited Warranty.

Air conditioning refrigerant

R-134a (HFC) refrigerant and special PAG lubricating oil are used in the air conditioning system.

Never use R-12 (CFC) or mineral-based lubricating oil, otherwise damage to the system will occur.

Brake fluid

During vehicle operation, the boiling point of the brake fluid is continuously reduced through the absorption of moisture from the atmosphere. Under extremely strenuous operating conditions, this moisture content can lead to the formation of bubbles in the system, thus reducing the system's efficiency.

Therefore, the brake fluid must be replaced every two years, preferably in the spring.

Only brake fluid approved by Mercedes-Benz is recommended. Your authorized Mercedes-Benz Center will provide you with additional information.

Premium unleaded gasoline



To maintain the engine's durability and performance, premium unleaded gasoline must be used. If premium unleaded is not available and low octane fuel is used, follow these precautions:

- Have the fuel tank only partially filled with unleaded regular and fill up with premium unleaded as soon as possible.
- Avoid full throttle driving and abrupt acceleration.
- Do not exceed an engine speed of 3000 rpm if the vehicle is loaded with a light load such as two persons and no luggage.
- Do not exceed $\frac{2}{3}$ of maximum accelerator pedal position if the vehicle is fully loaded or operating in mountainous terrain.

Fuel requirements

Only use premium unleaded gasoline meeting ASTM standard D 439:

- The octane number (posted at the pump) must be 91 min. It is an average of both the Research (R) octane number and the Motor (M) octane number: $(R+M) / 2$. This is also known as the ANTI-KNOCK INDEX.

Unleaded gasoline containing oxygenates such as ethanol, IPA, IBA and TBA can be used provided the ratio of any one of these oxygenates to gasoline does not exceed 10%; MTBE not to exceed 15%.

The ratio of methanol to gasoline must not exceed 3% plus additional cosolvents.

Using mixtures of ethanol and methanol is not allowed. Gasohol, which contains 10% ethanol and 90% unleaded gasoline, can be used.

These blends must also meet all other fuel requirements, such as resistance to spark knock, boiling range, vapor pressure, etc.

Gasoline additives

A major concern among engine manufacturers is carbon build-up caused by gasoline. Mercedes-Benz recommends only the use of quality gasoline containing additives that prevent the build up of carbon deposits.

After an extended period of using fuels without such additives, carbon deposits can build up especially on the intake valves and in the combustion area, leading to engine performance problems such as:

- Warm-up hesitation
- Unstable idle
- Knocking/pinging
- Misfire
- Power loss

Do not blend any specific fuel additives with fuel. This only results in unnecessary cost and may be harmful to the engine operation.

Damage or malfunctions resulting from poor fuel quality or from blending specific fuel additives are not covered by the Mercedes-Benz Limited Warranty.

Coolants

The engine coolant is a mixture of water and anticorrosion / antifreeze, which provides:

- Corrosion protection
- Freeze protection
- Boiling protection (by increasing the boiling point)

The cooling system was filled at the factory with a coolant providing freeze protection to approximately -22°F (-30°C) and corrosion protection.

If the antifreeze mixture is effective to -22°F (-30°C), the boiling point of the coolant in the pressurized cooling system is reached at approximately 266°F (130°C).

To provide important corrosion protection, the solution must be at least 45% anticorrosion/antifreeze (equivalent to freeze protection to approx. - 22°F [-30°C]). If you use a solution that is more than 55% anticorrosion/antifreeze (freeze protection to approx. - 49°F [-45°C]), the engine temperature will increase due to the lower heat transfer capability of the solution. Therefore, do not use more than this amount of anticorrosion/antifreeze.

If the coolant level is low, water and MB Anticorrosion /Antifreeze should be used to bring it up to the proper level (have cooling system checked for signs of leakage). Please make sure that the mixture is in accordance with label instructions.

The water in the cooling system must meet minimum requirements, which are usually satisfied by normal drinking water. If you are not sure about the water quality, consult your authorized Mercedes-Benz Center.

The coolant solution must be used year round to provide the necessary corrosion protection and increase boil-over protection. You should have it replaced every 15 years or 150 000 miles (250 000 km), whichever comes first.

Coolant system design and coolant used stipulate the replacement interval. The above replacement interval is only applicable if MB 325.0 anticorrosion/antifreeze solution or other Mercedes-Benz approved products of equal specification (see Factory Approved Service Products pamphlet) are used to renew the coolant concentration or bring it back up to the proper level.

Fuels, coolants, lubricants, etc.

Anticorrosion/antifreeze

Your vehicle contains a number of aluminum parts. The use of aluminum components in motor vehicle engines necessitates that anticorrosion/antifreeze coolant used in such engines be specifically formulated to protect the aluminum

parts. (Failure to use such anticorrosion/antifreeze coolant will result in a significantly shortened service life.)

Therefore, the following product is strongly recommended for use in your vehicle:

Mercedes-Benz Mercedes-Benz 325.0 Anticorrosion/Antifreeze Agent

Before the start of the winter season (or once a year in hot southern regions), you should have the anticorrosion/antifreeze concentration checked. The coolant is also regularly checked each time you bring your vehicle to your authorized Mercedes-Benz Center for service.

Anticorrosion/antifreeze quantity

Model	Approx. freeze protection	
	- 35°F (- 37°C)	- 49°F (- 45°C)
CLK 320	5.3 US qt (5.0 l)	5.9 US qt (5.5 l)
CLK 500	6.4 US qt (6.0 l)	7.0 US qt (6.6 l)
CLK 55 AMG	6.4 US qt (6.0 l)	7.0 US qt (6.6 l)

Windshield and headlamp washer system

Both the windshield and headlamp washer systems are supplied from the windshield washer fluid reservoir.

The washer fluid reservoir has a capacity of approx.

- 6.4 US qt. (6.0 l) in vehicles with headlamp cleaning system* or heated reservoir.

- ▶ Refill the reservoir with MB Windshield Washer Concentrate and water (or concentrate and commercially available premixed windshield washer solvent / antifreeze, depending on ambient temperatures).

Warning!



Washer solvent / antifreeze is highly flammable. Do not spill washer solvent / antifreeze on hot engine parts, because it may burn. You can be seriously burned.

Windshield and headlamp washer fluid mixing ratio

For temperatures above freezing use MB Windshield Washer Concentrate “S” and water:

- 1 part “S” to 100 parts water [40 ml “S” to 1 gallon (4 l) water].

For temperatures below freezing use MB Windshield Washer Concentrate “S” and commercially available premixed windshield washer solvent / antifreeze:

- 1 part “S” to 100 parts solvent [40 ml “S” to 1 gallon (4 l) solvent].

Consumer information

Consumer information

The following text is published as required of all manufacturers of passenger cars under Title 49, Code of U.S. Federal Regulations, Part 575 pursuant to the “National Traffic and Motor Vehicle Safety Act of 1966”.

Uniform tire quality grading

Quality grades can be found, where applicable, on the tire sidewall between tread shoulder and maximum section width. For example:

Tread wear	Traction	Temperature
200	AA	A

All passenger car tires must conform to federal safety requirements in addition to these grades.

Tread wear

The tread wear grade is a comparative rating based on the wear rate of the tire when tested under controlled conditions on a specified government test course. For example, a tire graded 150 would wear one and one-half (1½) times as well on the government course as a tire graded 100. The relative performance of tires depends upon the actual conditions of their use, however, and may depart significantly from the norm due to variations in driving habits, service practices and differences in road characteristics and climate.

Traction

The traction grades, from highest to lowest are AA, A, B, and C. Those grades represent the tire’s ability to stop on wet pavement as measured under controlled conditions on specified government test surfaces of asphalt and concrete. A tire marked C may have poor traction performance.

Warning!



The traction grade assigned to this tire is based on straight ahead braking traction tests, and does not include acceleration, cornering, hydroplaning, or peak traction characteristics.

Temperature

The temperature grades are A (the highest), B, and C, representing the tire's resistance to the generation of heat and its ability to dissipate heat when tested under controlled conditions on a specified indoor laboratory test wheel. Sustained high temperature can cause the material of the tire to degenerate and reduce tire life, and excessive temperature can lead to sudden tire failure. Grade C corresponds to a level of performance which all passenger car tires must meet under the Federal Motor Vehicle Safety Standard No. 109. Grades B and A represent higher levels of performance on the laboratory test wheel than the minimum required by law.

Warning!



The temperature grade for this tire is established for a tire that is properly inflated and not overloaded. Excessive speed, underinflation, or excessive loading, either separately or in combination, can cause excessive heat build-up and possible tire failure.

ABS

(Antilock Brake System)

Prevents the wheels from locking up during braking so that the vehicle can continue to be steered.

Alignment bolt

Metal pin with thread. The centering pin is an aid used when changing a tire to align the wheel with the wheel hub.

BabySmart™ airbag deactivation system

This system detects if a special system compatible child restraint seat is installed on the front passenger seat. The system will automatically deactivate the passenger front airbag when such a seat is properly installed (indicator lamp  in the center console lights up). See your authorized Mercedes-Benz Center for availability.

BabySmart™ compatible child seats

Special restraint system for children. The sensor system for the passenger seat prevents deployment of the passenger side airbag if a BabySmart™ compatible child seat is installed.

BAS

(Brake Assist System)

System for potentially reducing braking distances in emergency braking situations. The system is activated when it senses an emergency based on how fast the brake is applied.

Bi-Xenon headlamps*

Headlamps which use an electric arc as the light source and produce a more intense light than filament headlamps. Bi-Xenon headlamps produce low beam and high beam.

CAC

(Customer Assistance Center)
Mercedes-Benz customer service center, which can help you with any questions about your vehicle and provide assistance in the event of a breakdown.

CAN system

(Controller Area Network)
Data bus network serving to control vehicle functions such as door locking or windshield wiping.

Cockpit

All instruments, switches, buttons and indicator/warning lamps in the passenger compartment needed for vehicle operation and monitoring.

COMAND

(Cockpit Management and Data System)
Information and operating center for vehicle sound and communications systems, including the radio and navigation, as well as for other optional equipment (CD changer, telephone, etc.).

Control system

The control system is used to call up vehicle information and to change component settings. Information and messages appear in the multifunction display. The driver uses the buttons on the multifunction steering wheel to navigate through the system and to adjust settings.

Cruise control

Driving convenience system for automatically maintaining the vehicle speed set by the driver.

Distronic*

A driving convenience cruise control system which helps the driver maintain a pre-selected speed:

- If there is no vehicle directly ahead, the system operates in the same way as conventional ->cruise control.
- If a slower moving vehicle is ahead, Distronic will reduce your vehicle speed to the extent permitted by reduced throttle and up to 20% braking power to maintain the preset minimum following distance.

DTR

(->Distronic*)

Engine number

The number set by the manufacturer and placed on the cylinder block to uniquely identify each engine produced.

Engine oil viscosity

Measurement for the inner friction (viscosity) of the oil at different temperatures. The higher the temperature an oil can tolerate without becoming thin, or the lower the temperature it can tolerate without becoming viscous, the better the viscosity.

ESP

(Electronic Stability Program)
Improves vehicle handling and directional stability.

ETD

(Emergency Tensioning Device)
Device which deploys in certain frontal and rear collisions exceeding the system's threshold to tighten the seat belts.
->SRS

FSS

(Flexible Service System)
Service indicator in the multifunction display that informs the driver when the next vehicle maintenance service is due.

Gear range

Number of gears which are available to the automatic transmission for shifting. The automatic gear shifting process can be adapted to specific operating conditions using the selector lever.

GPS

(Global Positioning System)
Satellite-based system for relaying geographic location information to and from vehicles equipped with special receivers. Employs CD digital maps for navigation.

Instrument cluster

The displays and indicator/warning lamps in the driver's field of vision, including the tachometer, speedometer, engine temperature and fuel gauge.

KEYLESS-GO*

System for entering and operating the vehicle without the use of a key.

Kickdown

Depressing the accelerator past the point of resistance shifts the transmission down to the lowest possible gear. This very quickly accelerates the vehicle and should not be used for normal acceleration needs.

Line of fall

The direct line that an object moves downhill when influenced by the force of gravity alone.

Lock button

Button on the door which indicates whether the door is locked or unlocked. Pushing the lock button down on an individual door from inside will lock that door.

Memory function*

Used to store three individual seat, steering wheel and mirror positions for each key or, if so equipped, KEY-LESS-GO* feature.

Menu

The control system displays are arranged in menus. Each menu contains a number of commands for particular systems. In the Audio menu, for example, you will find the commands *Select radio station* or *Operate CD player*. Using commands you can directly change the settings for your vehicle.

MON

(Motor Octane Number)

The Motor Octane Number for gasoline as determined by a standardized method. It is an indication of a gasoline's ability to resist undesired detonation (knocking). The average of both the MON (Motor Octane Number) and →RON (Research Octane Number) is posted at the pump, also known as ANTI-KNOCK INDEX.

Multifunction display

Display field in the speedometer used to present information provided by the control system.

Multifunction steering wheel

Steering wheel with buttons for operating the control system.

Overspeed range

Engine speeds within the red marking of the tachometer dial. Avoid this engine speed range, as it may result in serious engine damage that is not covered by the Mercedes-Benz Limited Warranty.

Parktronic*

System which uses visual and acoustic signals to assist the driver during parking maneuvers.

Poly-V-belt drive

Drives engine-components (alternator, AC compressor, etc.) from the engine.

Power train

Collective term designating all components used to generate and transmit motive power to the drive axles, including

- engine
- clutch/torque converter
- transmission
- transfer case
- drive shaft
- differential
- axle shafts/axles

Program mode selector switch

Used to switch the automatic transmission between regular operation **S** and winter operation **W**.

CLK 55 AMG with steering wheel gearshift control and manual shift program. In addition to **S** and **C** (for regular **S** or comfort **C** operation, see above) you can use the **M** for manual shift program.

Remote Vehicle Diagnostics

Transmission of vehicle data and current location to the Mercedes-Benz Customer Assistance Center for subscribers to Tele Aid service.

REST

(Residual engine heat utilization)
Feature that uses the engine heat stored in the coolant to heat the vehicle interior for a short time after the engine has been turned off.

Restraint systems

Seat belts, belt tensioners, airbags and child restraint systems. As independent systems, their protective functions complement one another.

RON

(Research Octane Number)
The Research Octane Number for gasoline as determined by a standardized method. It is an indication of a gasoline's ability to resist undesired detonation (knocking). The average of both the →MON (Motor Octane Number) and RON (Research Octane Number) is posted at the pump, also known as ANTI-KNOCK INDEX.

Shift lock

When the vehicle is parked, this lock prevents the transmission selector lever from being inadvertently moved out of position **P** without key turned and brake pedal depressed.

Speedshift

Steering wheel gearshift control and manual shift program. In the manual shift program mode you can change the gears yourself on the steering wheel or by using the selector lever.

SRS

(Supplemental Restraint System)
Seat belts, emergency tensioning device and airbags. Though independent systems, they are closely interfaced to provide effective occupant protection.

Tele Aid System

(Telematic Alarm Identification on Demand)

The Tele Aid system consists of three types of response: automatic and manual emergency, roadside assistance and information. Tele Aid is initially activated by completing a subscriber agreement and placing an acquaintance call.

The Tele Aid system is operational providing that the vehicle's battery is charged, properly connected, not damaged and cellular and GPS coverage is available.

Telematics*

A combination of the terms "telecommunications" and "informatics".

Tightening torque

Force times lever arm (e.g. a lug wrench) with which threaded fasteners such as wheel bolts are tightened.

Tire speed rating

Part of tire designation; indicates the speed range for which a tire is approved.

Traction

Force exerted by the vehicle on the road via the tires.

VIN

(Vehicle Identification Number)

The number set by the manufacturer and placed on the body to uniquely identify each vehicle produced.

Voice control system*

Voice control system for car phones, portable cell phones and audio systems (radio, CD, etc.).

A

- ABS 23, 74, 361
 - ABS control 75
 - Malfunction indicator lamp 277
 - Messages in display 284
 - Warning lamp 277
- Accelerator position, automatic transmission 146
- Accident
 - In case of 49
- Activating
 - Air conditioning (cooling) 163
 - Air recirculation mode 160
 - Anti-theft alarm system 80
 - Automatic climate control 155
 - Central locking (control system) 133
 - Charcoal filter 161
 - Distance warning function* 205
 - Distrionic* 201
 - Easy-entry/exit feature 133
 - ESP 78
 - Exterior headlamps 46
 - Exterior lamps 106
 - Front and rear fog lamp 106
 - Hazard warning flasher 108
 - Headlamps 46
 - High beams 108
 - Ignition 31
 - Ignition with KEYLESS-GO* start/stop button 33
 - Immobilizer 51, 79
 - Rear window defroster 162
 - Residual heat 163
 - Seat heater* 101
 - Tow-away alarm 81
 - Windshield wipers 48
- Activating steering wheel gearshift control 147
 - Downshifting 148
 - Upshifting 147
- Adding
 - Coolant 257
 - Engine oil 255
- Additional turn signals 317
- Adjustable air vents, rear passenger compartment 164
- Adjusting 34
 - Air distribution 158
 - Air volume 159
 - Backrest tilt 36
 - Exterior rear view mirror 38
 - Head restraint height 36
 - Head restraint tilt 36
 - Inside rear view mirror 38
 - Instrument cluster illumination 111
 - Mirrors 38
 - Multicontour seat* 100
 - Seat cushion depth 100
 - Seat cushion tilt 36
 - Seat fore and aft adjustment 35
 - Seat height 35
 - Seats 34
 - Steering column height 38
 - Steering column length 38
 - Steering wheel 37
- Air conditioning (cooling)
 - Turning off 163
 - Turning on 163
- Air conditioning refrigerant 353
- Air distribution
 - Adjusting 158

- Air pressure see Tire inflation pressure 262
- Air recirculation mode 160
 - Activating 160
 - Deactivating 160
- Air vents, rear passenger compartment
 - Adjustable 164
- Air volume
 - Adjusting 159
- AIRBAG OFF indicator lamp 282
- Airbags 57
 - BabySmart™ airbag deactivation system 361
 - BabySmart™ deactivation system 68
 - Children 58
 - Front 61
 - Passenger 61
 - Safety guidelines 60
 - Side impact 61
 - Window curtain 61
- Alarm
 - Audible 73, 80
 - Canceling 80
 - Visual 80
- Alarm system
 - Anti-theft 80
- Alignment bolt 326
- Alignment bolt (vehicle tool kit) 361
- Anticorrosion/antifreeze 356
- Antiglare
 - Automatic 149
- Antilock brake system (ABS) 361
- Anti-theft alarm system
 - Arming 80
 - Canceling alarm 80
 - Disarming 80
- Anti-theft systems 79
 - Anti-theft alarm system 80
 - Immobilizer 79
 - Tow-away alarm 81
- Aquaplaning see Hydroplaning 245
- Armrest
 - Storage spaces 221
- Ashtray 223
- At the gas station 251
- ATF (automatic transmission fluid) 256
- AUDIO menu 119
 - Selecting radio station 120
- Audio system
 - Audio and telephone, operation 165
 - Button and soft key operation 168
 - Cassette mode 174
 - CD mode 178
 - Operating and display elements 166
 - Operating safety 165
 - Operation 168
 - Radio mode 171
 - Switching off 168
 - Switching on 168
 - Telephone operation 182
- Audio systems 165
- Automatic antiglare for rear view mirror 149
- Automatic central locking
 - Activating/deactivating (control system) 133
- Automatic climate control 154
 - Adjusting air distribution 158
- Air recirculation mode 160
- Defrosting 159
 - Rear window defroster 162
 - Setting the temperature 157
- Automatic headlamp mode 106

- Automatic lighting control
 - Activating 109
 - Deactivating 109
- Automatic locking when driving 95
- Automatic transmission 141
 - Accelerator position 146
 - Activating steering wheel gearshift control 147
 - Deactivating steering wheel gearshift control 148
 - Emergency operation (Limp Home Mode) 146
 - Fluid level 256
 - Gear ranges 143
 - Gear selector lever position 144
 - Gear shifting malfunctions 146
 - Kickdown 146
 - Manual shift program, CLK 55 AMG 146
 - One-touch gearshifting 142
 - Program mode selector switch 145
 - Selector lever position 141
 - Speedshift, CLK 55 AMG 146
 - Starting the engine 43
 - Steering wheel gearshift control (Speedshift), CLK 55 AMG 146
 - Transmission fluid 256
 - Winter program mode 145, 147
- Auxiliary fuse box 338
- B**
- BabySmart™
 - Airbag deactivation system 68
 - Compatible child seats 68, 361
 - Self-test 68
- BabySmart™ airbag deactivation system 361
- Backrest
 - Folding forward 216
 - Folding rearward 217
- Backup lamps 317, 322
 - Bulbs 317
- BAS 76, 361
 - Messages in display 285
- Batteries, SmartKey
 - Changing 312
 - Check lamp 85
 - Checking 86
- Batteries, SmartKey with KEYLESS-GO*
 - Changing 312
 - Checking 86
- Battery discharged
 - Jump starting 332
- Battery, vehicle 258, 329
 - Charging 330
 - Disconnecting 330
 - Messages in display 303
 - Reconnecting 331
 - Reinstalling 330
 - Removing 330
- Bi-Xenon headlamps* 361
- Block heater* 265
- Blocking
 - Rear window operation 72
- Bolts
 - For Minispare wheel 309
- Brake assist system (BAS) 361
- Brake fluid 353
- Brake lamp bulbs 317
- Brake lamp, high mounted 317
- Brake pads
 - Message in display 286
- Brakes 242
 - Warning lamp 279
- Break-in period 240

- Bulbs, replacing 316
 - Additional turn signals 317
 - Backup lamps 317
 - Brake lamps 317
 - Fog lamps 317
 - Front lamps 317
 - High beam 317
 - High mounted brake lamp 317
 - License plate lamps 317, 322
 - Low beam 317
 - Parking lamps 317, 319, 321
 - Rear fog lamp 317
 - Rear fog lamps 322
 - Side marker lamps 317, 321
 - Standing lamps 317, 319, 321
 - Tail lamp assemblies 317, 322
 - Turn signal lamps 317
- Button
 - Audio system 168
- C**
 - CAC (Customer Assistance Center) 362
 - Calling up
 - Distronic* settings 121
 - Range (distance to empty) 137
 - Service indicator 267
 - CAN system 362
 - Capacities
 - Fuels, coolants, lubricants, etc. 351
 - Cargo tie-down rings 218
 - Cassette mode
 - Playing cassettes 174
 - Cassette player
 - Operating 121
 - Catalytic converter 248
 - CD changer* 178
 - CD mode 178
 - CD player
 - Operating 120
 - Center console 25
 - AIRBAG OFF indicator lamp 282
 - Lower part 26
 - Upper part 25
 - Centigrade
 - Setting temperature units 126
 - Central locking
 - Automatic 95
 - From inside 95
 - Switch 95
 - Switching on/off (control system) 133
 - Unlocking from inside 95
 - Central locking switch 95
 - Changing
 - Batteries (SmartKey with KEY-LESS-GO*) 312
 - Batteries (SmartKey) 312
 - Key setting 133
 - Changing CDs 178
 - Charcoal filter 161
 - Activating 161
 - Deactivating 161
 - Charging
 - Vehicle battery 330
 - CHECK ENGINE malfunction indicator lamp 280
 - Checking
 - Coolant level 256
 - Oil level 252, 254
 - Tire inflate pressure 252
 - Vehicle lighting 252

- Child safety 66
 - Airbags 58
 - Infant and child restraint systems 62, 66
 - LATCH child seat mounts 71
- Child safety switch see Blocking of rear window operation 72
- Child seat mounts see LATCH child seat mounts 71
- Cigarette lighter 224
- Cleaning
 - Cup holder 273
 - Distronic* system sensor cover 271
 - Gear selector lever 273
 - Hard plastic trim items 273
 - Headlamps 151
 - Headliner 273
 - Instrument cluster 273
 - Leather upholstery 273
 - Light alloy wheels 272
 - Parktronic* system sensor 272
 - Plastic and rubber parts 273
 - Seat belts 273
 - Steering wheel 273
 - Windows 272
 - Windshield 48
 - Wiper blades 272
- Clock 23, 128
- Closing
 - Cup holder 220, 221
 - Glove box 219
 - Hood 254
 - Side windows 187
 - Side windows with KEYLESS-GO* 91
 - Sliding/pop-up roof 190, 314
 - Sliding/pop-up roof with KEYLESS-GO* 189, 192
 - Sliding/pop-up roof with SmartKey 191
 - Sliding/pop-up roof* with KEYLESS-GO* 91
 - Trunk 94
 - Windows 187
 - Windows with KEYLESS-GO* 189, 192
 - Windows with SmartKey 188
- Closing sliding/pop-up roof
 - In an emergency 314
- Cockpit 20, 362
- Cockpit management and data system (COMAND*) 362
- COMAND* 362
- COMAND* see separate operating instructions

- Combination switch 107
 - High beam flasher 47, 108
 - Turn signals 47
 - Windshield wipers 47
 - Consumer information 358
 - Control and operation of radio transmitters 248
 - Control system 114, 362
 - AUDIO menu 119
 - Convenience submenu 133
 - Display digital speedometer 119
 - Distronic* menu 121
 - Functions 115, 118
 - Instrument cluster submenu 126, 128
 - Lighting submenu 129
 - Malfunction memory menu 122
 - Menus 117, 118, 364
 - Multifunction display 114
 - Multifunction steering wheel 115
 - NAVI menu 121
 - Selecting radio system 120
 - Settings menu 123
 - Standard display menu 119
 - Submenus 116, 118
 - TEL* menu 138
 - Trip computer menu 136
 - Vehicle submenu 132
 - Convenience submenu 133
 - Activating easy-entry/exit feature 133
 - Setting key dependency 135
 - Setting parking position for exterior rear view mirror 135
 - Coolant 256, 355
 - Adding 257
 - Anticorrosion/antifreeze quantity 355
 - Capacities 351
 - Checking level 256
 - Messages in display 289, 290
 - Temperature 250
 - Temperature display 112
 - Warning lamp 281, 290
 - Coolant level
 - Checking 256
 - Cruise control 193, 362
 - Canceling 194
 - Driving downhill 194
 - Driving uphill 194
 - Fine adjustment 195
 - Lever 200
 - Saving current speed 194
 - Setting speeds 195
 - Cruise control lever 193
 - Cup holder
 - Cleaning 273
 - Closing 220, 221
 - In rear seat armrest 220
 - In the dashboard 220
 - Opening 220, 221
 - Customer Assistance Center (CAC) 362
- D**
- Daytime running lamp mode 106
 - Setting 129, 130
 - Deactivating
 - Air conditioning (cooling) 163
 - Air recirculation mode 160
 - Alarm 80
 - Anti-theft alarm system 80
 - Automatic climate control 155
 - Central locking (control system) 133
 - Cruise control 194
 - Defrost 159
 - Distance warning function* 205
 - Distronic* 203
 - Engine with KEYLESS-GO* 52
 - Engine with the key 51
 - ESP 78
 - Exterior lamps 106
 - Hazard warning flasher 108

- Headlamps 51
- Immobilizer 79
- Interior lighting delayed switch-off 132
- Rear window defroster 162
- Residual heat 164
- Seat heater 101
- Tow-away alarm 81
- Deactivating steering wheel gearshift control 148
- Deceleration
 - With Distronic* 199
- Deep water see Standing water 247
- Defogging
 - Windshield 158
- Defrosting 159
- Delayed switch-off
 - Interior lighting 132
- Dialing
 - A number (telephone) 139
- Difficulties
 - While driving see Problems while driving 49
 - With starting 44
- Digital speedometer 119
- Direction of rotation (tires) 261
- Discharged battery
 - Jump starting 332
- Disconnecting
 - Vehicle battery 330
- Display
 - Selecting 127, 128
- Display elements
 - Audio system 166
- Displays
 - Digital speedometer 119
 - Distronic* 198
 - Messages 256, 283
 - Selecting 127
 - Service indicator 266
 - Showing malfunctions 123
- Distance
 - Decreasing in Distronic* 204
 - Increasing in Distronic* 204
 - Setting in Distronic* 203
 - Warning function 204
- Distance to empty (range)
 - Calling up 136
- Distance warning function* 204
 - Activating 205
 - Deactivating 205
 - DTR* warning lamp 204
 - Intermittent warning sound 204
 - Symbol in multifunction display 122
- Distronic* 196, 362
 - Activated 200
 - Activating 201
 - Calling up settings 121, 199
 - Cleaning system sensor 271
 - Cruise control lever 200
 - Deactivated 200
 - Deactivating 203
 - Deceleration 199
 - Decreasing distance 204
 - Decreasing time interval 203
 - Displays in the speedometer dial 198
 - Distance warning function 204
 - Driving hints 205
 - Fine adjustment 202
 - Increasing distance 204
 - Increasing time interval 203
 - Intermittent signal tone 198
 - Menu 199
 - Messages in display 292

- Resetting stored speed 202
- Sensor cover 271
- Setting a higher speed 201
- Setting a slower speed 202
- Setting following distance 203
- Setting the current speed 201
- Warning and indicator lamps 198
- Door control panel 28
- Door entry lamps 110
- Door handle 28
- Door unlock
 - With Tele Aid* 234
- Doors
 - Message in display 292
 - Opening from inside vehicle 92
 - Opening from outside 85, 89
- Downhill driving
 - Cruise control 194
- Downshifting 142
 - Steering wheel gearshift control 148
- Drinking and driving 241

- Driving
 - General instructions 40, 241
 - Hydroplaning 245
 - In winter 246
 - Problems 49
 - Safety systems 74
 - Through standing water 247
 - Traveling abroad 247
 - With DISTRONIC* 205
- Driving instructions 241
- Driving off 243
- Driving safety systems
 - ABS 74
 - BAS 76
 - ESP 76
- Driving systems 193
 - Cruise control 193
 - DISTRONIC* 196
 - Driving safety systems 74
- DTR see DISTRONIC* 362

- E**
- Easy-entry/exit feature 97
 - Activating 133
 - Interrupting movement 134
- Electrical fuses 337
- Electrical system
 - Technical data 348
- Electronic Stability Program see ESP 23, 76
- Electronic stability program see ESP 363
- Emergency call
 - Telephone 185
- Emergency call system* 227
- Emergency calls
 - Initiating an emergency call 230
 - With Tele Aid* 228
- Emergency operation (Limp Home Mode) 146
- Emergency operations
 - Closing sliding/pop-up roof 314
 - Locking the vehicle 311
 - Opening sliding/pop-up roof 314
 - Remote door unlock 234
 - Unlocking the trunk lid 311
 - Unlocking the vehicle 310

- Emergency tensioning device see ETD 65, 363
- Emission control 249
- Emission control label 342
- Ending
 - A call (telephone) 139
- Engine
 - Compartment 253
 - Message in display 280
 - Starting 43
 - Starting with KEYLESS-GO* 44
 - Starting with the key 44
 - Technical data 344
 - Turning off with the key 51
- Engine cleaning 270
- Engine compartment 253
 - Fuse box in 337
 - Hood 253
- Engine malfunction indicator lamp 23, 280
- Engine number 363
- Engine oil 254, 353
 - Adding 255
 - Additives 353
 - Checking level 254
 - Consumption 254
 - Display messages 294
 - Filler neck 255
 - Messages in display 256
 - Viscosity 363
- Engine oil level see Oil level 252
- ESP 23, 76, 363
 - Messages in display 293
 - Switching off 78
 - Switching on 78
 - Warning lamp 276
- ETD 363
 - Safety guidelines 60
- ETD (Emergency tensioning device) 65
- Exterior lamp switch 105
- Exterior rear view mirrors
 - Adjusting 38
 - Parking position for 135, 150
- F**
- Fahrenheit
 - Setting temperature units 126
- Fastening the seat belts 40
- Fine adjustment
 - Cruise control 195
 - Distronic* 202
- First aid kit 305
- Flat tire 324
 - Lowering the vehicle 328
 - Minispare wheel 307
 - Mounting the Minispare wheel 324
 - Preparing the vehicle 324
- Flexible Service System (FSS) 266, 363
- Floor mats* 225
- Fog lamp, rear 107, 317
- Fog lamps
 - Replacing bulbs 317
- Fog lamps, front
 - Messages in display 298
 - Replacing bulbs 318
 - Switching on 107
- Front airbags 61

- Front lamps
 - Messages in display 296–299
 - Replacing bulbs 317, 318
 - Switching on 105
- Front seat head restraints
 - Installing 98
 - Power seat 98
 - Removing 98
- Front seats
 - Heater* 101
- FSS (Flexible Service System) 266, 363
- Fuel 251
 - Additives 354
 - Fuel reserve warning lamp 280
 - Gasoline additives 354
 - Premium unleaded gasoline 251, 352, 354
 - Requirements 354
 - Reserve warning 23
 - Technical data 351
- Fuel additives 354
- Fuel consumption statistics
 - After start 136
 - Since last reset 137
- Fuel filler flap 251
 - Locking 251
 - Opening 313
 - Unlocking 251
- Fuel requirements 354
- Fuel reserve tank
 - Message in display 296
- Fuel tank
 - Capacity 352
 - Filler flap 251
- Fuels, coolants, lubricants etc.
 - Capacities 351
- Functions (control system) 115, 118
 - Resetting 124
- Fuse box 337
- Fuse chart 337
- Fuse extractor 338
- Fuses 337
 - Auxiliary fuse box in trunk 338
 - Fuse box in engine compartment 337
 - Fuse box in passenger compartment 337
 - Fuse chart 337
 - Fuse extractor 338
 - Spare fuses 338
- G**
- Garage door opener 27, 235
 - Erasing in remote control 238
 - Integrated remote control 236
 - Rolling code programming 237
- Gasoline see Fuel 251
 - Gasoline additives 354
- Gear range 363
 - Automatic transmission 143
 - Limiting 143
 - Shifting into optimal 142
- Gear range limit
 - Canceling 142
- Gear selector lever
 - Cleaning 273
 - Position 144
- Global
 - Locking 85
 - Locking with KEYLESS-GO* 90
 - Unlocking 85
 - Unlocking with KEYLESS-GO* 89
- Global Positioning System (GPS) 363
- Glove box 21, 219
 - Closing 219
 - Opening 219
- Good visibility 149

GPS 363
 GPS see COMAND* 233

H

Hand-held transmitter
 Programming integrated remote control 236

Hands-free microphone 27

Hard plastic trim items
 Cleaning 273

Hazard warning flasher 108
 Switching off 108
 Switching on 108

Head restraints 97

Headlamp cleaning system* 259

Headlamps
 Automatic control 106
 Bi-Xenon 361
 Cleaning 271
 Cleaning system* 151, 259
 Refilling washer fluid 259
 Switching off 51
 Switching on 46
 Washer fluid 357
 Washer system* 357

Headliner
 Cleaning 273

Heated seats* 101

Height adjustment
 Head restraints 36
 Steering wheel 37

High beam flasher 47, 108

High beam headlamps
 Messages in display 298
 Replacing bulbs 317, 319
 Switching on 108

High mounted brake lamp 317

Hood 253
 Closing 254
 Message in display 296
 Opening 253

Hydroplaning 245

I

Identification labels 342

Ignition 31, 33
 Switching on 44

Immobilizer 79
 Activating 79
 Deactivating 79

Indicator lamps see Lamps, indicator and warning

Infant and child restraint systems 66
 Installing 70
 LATCH child seat mounts 71

Information
 About service and warranty 10
 Button for Tele Aid* 232

Inside rear view mirror
 Adjusting 38
 Antiglare 149

Installing
 Infant and child restraint systems 70
 Towing eye bolt 336
 Wiper blades 323

Instrument cluster 22, 111, 363
 Cleaning 273
 Coolant temperature display 112
 Illumination 111
 Lamps in 276–280
 Multifunction display 114
 Outside temperature indicator 113
 Selecting language 127

Instruments and controls see Cockpit 20

- Integrated remote control
 - Canadian programming 237
 - Erasing memory 238
 - Hand-held transmitter 236
 - Operating 238
 - Rolling code programming 237

- Interior lighting 109
 - Activating automatic control 109
 - Deactivating automatic control 109
 - Delayed switch-off 132
 - Manual operation 110
- Interior storage spaces 219
 - Armrest 221
 - Glove box 219
 - Parcel net 222
 - Storage bags 222

J

- Jack 305, 306
- Jump starting 332

K

- Key dependency memory
 - Settings 135
- Key positions in starter switch 31
- Key, mechanical 310
- Key, SmartKey
 - Battery check lamp 85
 - Changing battery 312
 - Changing the batteries 312
 - Checking the batteries 86
 - Factory setting 85
 - Global locking 85
 - Global unlocking 85
 - Loss of 87
 - Positions in starter switch 31
 - Remote controls 84
 - Restoring to factory setting 85
 - Selective setting 85
 - Starting the engine 44
 - Turning off the engine 51
 - Unlocking with 30
- Key, SmartKey with KEYLESS-GO*
 - Changing the batteries 312
 - Turning off the engine 52

KEYLESS-GO* 363

- Activating ignition with 33
 - Closing side windows 91
 - Closing sliding/pop-up roof with 189, 192
 - Closing sliding/pop-up roof* 91
 - Closing windows with 189, 192
 - Factory setting 89
 - Global locking 90
 - Global unlocking 89
 - Important notes 88
 - Locking the vehicle 91
 - Messages in display 288
 - Remote controls 88
 - Starting the engine 44
 - Turning off engine 52
 - Unlocking with 32
 - Unlocking, trunk lid 90
- Keys 84
 - Kickdown 146, 363
 - Kilometers/miles in speedometer 126
 - Km/h or mph in speedometer 126

L

Labels, identification 342

Lamp bulbs, exterior 316

Lamps, exterior

Front 317

Light sensor 296

Messages in display 296–299

Rear 317

Lamps, indicator and warning

ABS 277

Airbag Off 61

Battery (SmartKey) 85

Brakes 279

CHECK ENGINE 280

Coolant 281, 289

DTR* 198

Engine diagnostics 280

ESP 276

Fuel reserve 280

Instrument cluster 276–281

Seat belts 280

Service indicator 266

SRS 57

Turn signals 23

Language

Multifunction display 127

Setting 127

LATCH child seat mounts 71

Folding back 71

Layout of poly-V-belt drive 343

Leather upholstery

Cleaning 273

Lever

For cruise control 200

License plate lamps

Messages in display 298

Replacing bulbs 317, 322

Light alloy wheels

Cleaning 272

Technical data 345

Light sensor 296

Lighter see Cigarette lighter 224

Lighting 105

Automatic headlamp mode 106

Combination switch 108

Daytime running lamp mode 106

Door entry lamps 110

Exterior lamp switch 105

Front fog lamps 107

High beam flasher 108

High beams 108

Instrument cluster illumination 111

Interior 109

Locator lighting 107

Low beam 105

Manual headlamp mode 106

Night security illumination 107

Parking lamps 105

Rear fog lamp 107

Settings (control system) 129

Limiting the gear range 143

Limp Home Mode 146

Line of fall 363

- Loading 212
 - Cargo tie-down rings 218
 - Instructions 217
 - Roof rack 212
 - Ski sack* 212
 - Split rear bench seat 215
- Locator lighting 107
 - Setting 130
- Lock button 363
- Lock buttons 363
 - Door handle (KEYLESS-GO*) 53
- Locking 50, 84
 - Fuel filler flap 251
 - Global with KEYLESS-GO* 90
 - Global, SmartKey 85
 - The vehicle with KEYLESS-GO* 91
 - Trunk lid, separately 94
 - Vehicle in an emergency 311
- Loss of keys 87, 91
- Loss of Service and Warranty Information
 - Booklet 341
- Low beam headlamps
 - Messages in display 296
 - Replacing bulbs 317, 319
- Lowering
 - Vehicle 328
- Lubricants
 - Technical data 351
- M**
- Main dimensions 349
- Maintenance 12, 266
- Malfunction
 - Displaying 123
- Malfunction memory 122
 - Calling up 122
- Manual headlamp mode 106
- Manual operations
 - Fuel filler flap 313
 - Interior lighting control 110
 - Locking the vehicle 311
 - Sliding/pop-up roof 314
 - Unlocking the driver's door 310
 - Unlocking the trunk lid 311
 - Unlocking transmission selector lever 313
- Manual shift program, CLK 55 AMG 146
- MAXCOOL maximum cooling 159
- Mechanical key 310
- Memory function 102, 364
 - Recalling positions from memory 103
 - Storing exterior rear view mirror parking positions 103
 - Storing key dependent settings 103
- Menus 115
 - AUDIO 119
 - Control system 364
 - Distronic* 121, 199
 - In control system 117, 118
 - Malfunction memory 122
 - NAVI 121
 - Settings menu 123
 - Standard display 119
 - Submenus 116
 - TEL* 138
 - Trip computer 136
- Microphone
 - Hands-free microphone 27
- Miles/kilometers in speedometer
 - Setting 126
- Minispare wheel 307
 - Bolts 309
 - Mounting 324
 - Technical data 347

Mirrors

- Adjusting 38
- Automatic antiglare for rear view mirror 149
- Exterior rear view mirror 38
- Exterior rear view mirror parking position 150
- Exterior rear view mirror parking positions 135
- Inside rear view mirror 38
- Storing exterior mirror parking position 103

MON 251

MON (Motor Octane Number) 364

Mph or km/h in speedometer 126

Multicontour seat* 100

Multifunction display 114, 364

- Selecting language 127

- Standard display 118

Multifunction display messages

- ABS 284

- BAS 285

- Battery 303

- Brake fluid 287

- Brake pads 286

- Check engine 280

- Coolant 290
- Coolant level 289
- Display 304
- Distronic* 292
- Doors 292
- Engine 280
- ESP 293
- Fuel reserve tank 296
- Hood 296
- Key 296
- Lamps 296–299
- Parking brake 299
- Selector lever 292
- SmartKey with KEYLESS-GO* 288
- Steering gear oil level 300
- Tele Aid 301
- Telephone* 301
- Trunk 301
- Washer fluid 301
- Multifunction steering wheel 24, 115, 364
- Buttons 115

N

Navigation system

- Operating 121

- See separate COMAND* operating instructions

Night security illumination 107

O

Occupant safety 56

- Airbags 57

- Children and airbags 58

- Children in the vehicle 66

- Fastening the seat belt 40

- Infant and child restraint systems 66

- LATCH child seat mounts 71

- Seat belts 40, 60

Odometer, main 23

Oil

- Adding 255

- Checking level 254

- Consumption 254

- Filler neck 255

- Viscosity 363

Oil level

- Checking 252

- One-touch gearshifting 142
 - Canceling gear range limit 142
 - Downshifting 142
 - Upshifting 142

Opening

- Ashtray 223
- Cup holder 220, 221
- Doors from the inside 92
- Fuel filler flap 251
- Fuel filler flap manually 313
- Glove box 219
- Hood 253
- Side windows 187, 188
- Sliding/pop-up roof 190, 314
- Sliding/pop-up roof in an emergency 314
- Sliding/pop-up roof with SmartKey 191
- Trunk 87
- Trunk from the inside 92
- Windows 187
- Windows with SmartKey 188

Operating

- Audio system 165
- Cassette player 121
- CD player 120
- COMAND* see separate operating instructions
- Garage door opener 238
- Integrated remote control 238
- Navigation system 121
- Radio 120
- Radio transmitters 248
- Safety 16
- Telephone 165
- Telephone* 138, 182
- Vehicle outside the USA and Canada 13
- Operating safety 16
 - Audio system 165
- Operator's Manual 10
- Ornamental moldings 271
- Outside temperature indicator 113
- Overdue service 266
- Overhead control panel 27
- Overspeed range 364

P

- Paintwork 270
- Panic alarm 73
 - Panic button on SmartKey 73
- Parcel net in front passenger footwell 222
- Parking 50, 243
- Parking brake 45, 50
 - Engaging 50
 - Message in display 299
 - Releasing 45
- Parking lamps
 - Replacing bulbs 317, 319, 321
 - Switching on 105
- Parking position
 - Exterior rear view mirrors 103, 135, 150
- Parktronic* 364
 - Sensor 272
- Parts see Spare parts service 340

- Passenger compartment 247
 - Fuse box in 337
 - Inside rear view mirror 38
 - Interior lighting 109
 - Parcel net in front passenger footwell 222
 - Storage bags, rear side of the front seats 222
- Passenger safety see Occupant safety 56
- Pedals 241
- Phone book*
 - Loading 139
 - Quick search 139
- Phone number*
 - Dialing 139
 - Redialing 140
- Plastic and rubber parts
 - Cleaning 273
- Playing
 - CDs 179
- Poly-V-belt drive 364
 - Layout 343
- Positions (Memory function)
 - Recalling from memory 103
 - Storing into memory 103
- Power assistance 241
- Power seat
 - Adjusting backrest tilt 36
 - Adjusting head restraint height 36
 - Adjusting head restraint tilt 36
 - Adjusting seat cushion tilt 36
 - Adjusting seat height 35
 - Front seat head restraints 98
 - Seat fore and aft adjustment 35
- Power train 364
- Power washer 269
- Power windows 187
 - Blocking of rear window operation 72
 - Side windows 187
 - Synchronizing 189
- Practical hints
 - First aid kit 305
 - Fuses 337
 - Lamp in center console 282
 - Lamps in instrument cluster 276
 - Messages in the display 283
 - Minispare wheel 307
 - Spare wheel bolts 309
 - Towing the vehicle 334
 - Vehicle jack 306
 - Vehicle tool kit 305
- Premium unleaded gasoline 354
- Problems
 - While driving 49
 - With vehicle 17
- Product information 9
- Program mode selector switch 364
 - Automatic transmission 145
- Q**
- Quick search
 - Phone book* 139
- R**
- Radio
 - Selecting stations 120
 - Station search 120
 - Station selection setting 132
- Radio mode 171
- Radio see Radio mode
- Radio transmitters, control and operation 248
- Range (distance to empty)
 - Calling up 137
- Rapid seat heating*
 - Switching on 101
- Reading lamp 27
- Rear bench seat
 - Foldable 215

- Rear fog lamp 317
 - Bulb 317
 - Switching on 107
- Rear lamp bulbs
 - Replacing 322
- Rear lamps see Tail lamps
- Rear passenger compartment
 - Adjustable air vents 164
- Rear seat head restraints
 - Folding back with release button 99
 - Folding back with switch 98
 - Installing 99
 - Placing upright 99
 - Rear seats 98
 - Removing 99
- Rear seats
 - Rear seat head restraints 98
- Rear view mirror automatic antiglare 149
- Rear view mirrors see Mirrors
- Rear window
 - Blocking operation 72
- Rear window defroster 162
 - Activating 162
 - Deactivating 162
- Rear window sunshade* 153
- Reconnecting
 - Vehicle battery 331
- Refrigerant
 - Air conditioning 353
- Regular checks 252
- Reinstalling vehicle battery 330
- Remote controls
 - Integrated 236
 - SmartKey 84
 - SmartKey with KEYLESS-GO* 88
- Remote door unlock
 - With Tele Aid* 234
- Remote Vehicle Diagnostics 365
- Removing
 - Ski sack 215
 - Vehicle battery 330
 - Wheel 326
 - Wiper blades 323
- Replacing
 - Backup lamp bulbs 322
 - Brake lamp bulbs 322
 - Bulbs 316
 - Front lamp bulbs 318
 - Front turn signal bulbs 319
 - Fuses 338
 - High beam bulbs 319
 - License plate lamp bulbs 322
 - Low beam bulbs 319
 - Parking lamp bulbs 319, 321
 - Rear fog lamp bulbs 322
 - Rear lamp bulbs 317, 322
 - Rear turn signal bulbs 322
 - Side marker lamp bulbs 321
 - Standing lamp bulbs 319, 321
 - Wiper blades 323
- Reporting
 - Safety defects 18
- Reset knob in the instrument cluster 124

Resetting

- All functions (control system) 124
- All functions of a submenu 124
- Fuel consumption 137
- Service indicator (FSS) 267
- Stored speed in DISTRONIC* 202
- Trip odometer 112

Residual heat utilization 163, 365

Residual ventilation 163

REST (Residual engine heat utilization) 365

Restraint system see Infant and child restraint systems 66, 70

Rims 345

Roadside assistance 12

Tele Aid* 231

Rolling code programming 237

RON 251

RON (Research Octane Number) 365

Roof rack 212

Rotating wheels 263

Rubber parts

Cleaning 273

S

Safety

Occupant 56

Safety belts see Seat belts 40

Safety defects

Reporting 18

Safety systems

Driving 74

Saving current speed 194

Searching

Radio station 120

Seat belt force limiter 65

Seat belts 62

Cleaning 273

Fastening 40

Proper use of 42, 64

Safety guidelines 60

Warning lamp 280

Seat cushion depth

Adjusting 100

Seat heater*

Switching off 101

Switching on 101

Seats 97

Adjusting 34

Easy entry/exit feature 97

Heater* 101

Multicontour seat* 100

Rapid seat heating* 101

Split rear bench seat 215

Securing cargo

Cargo tie-down rings 218

Selecting

Display 127

Selecting display 128

Selector lever 23

Lock 43

Message in display 292

Position 23, 141

Self-test

BabySmart™ airbag deactivation system 68

Tele Aid* 228

- Service
 - Calling up the service indicator 267
 - Major service (Service B) 266
 - Minor service (Service A) 266
 - Overdue 266
 - Spare parts 340
 - Types 266
 - When due 266
- Service (maintenance) 266
- Service and Warranty Booklet
 - Loss of 341
- Service and warranty information 10
- Service indicator 266
 - Calling up 267
 - Clearing 266, 267
- Service life (tires) 261
- Service System see FSS 266
- Setting
 - Convenience functions 125, 133
 - Cruise control 194
 - Daytime running lamp mode 129, 130
 - Distronic* time interval 203
 - Exterior rear view mirror parking position 103
 - Following distance in Distronic* 203
 - Higher speed in cruise control 195
 - Higher speed in Distronic* 201
 - Hours (clock) 128
 - Individual vehicle settings 123
 - Interior lighting delayed switch-off 132
 - Key dependent memory 135
 - Lamps and lighting (control system) 129
 - Language, multifunction display 127
 - Locator lighting 130
 - Lower speed in cruise control 195
 - Lower speed in Distronic* 202
 - Miles/kilometers in speedometer 126
 - Minutes (clock) 129
 - Parking position for exterior rear view mirrors 135
 - Slower speed in cruise control 195
 - Slower speed in Distronic* 202
 - Speed in cruise control 195
 - Speed in Distronic* 201
 - Speedometer display mode 126
 - Station selection mode 132
 - Temperature (interior) 157
 - Temperature indicator 126
 - Units
 - Speedometer 126
 - Temperature 126
- Settings
 - Calling up Distronic* 121, 199
 - Convenience functions 133
 - Factory, KEYLESS-GO* 89
 - Factory, SmartKey 85
 - Individual (SmartKey) 135
 - Lighting (control system) 129
 - Menus and submenus 116
 - Resetting all (control system) 124
 - Resetting in the submenu 124
 - Selective 85
- Settings menu
 - Functions in 123
 - Individual vehicle settings 123
 - Submenus 124
- Shift lock 365
- Shifting
 - Gear selector lever positions 144
 - Into optimal gear range (automatic transmission) 142
- Side impact airbags 61
- Side marker lamps
 - Replacing bulbs 317, 321

- Side windows
 - Automatic opening 188
 - Cleaning 272
 - Closing 187, 188
 - Closing with KEYLESS-GO* 91, 189, 192
 - Closing with SmartKey 188
 - Opening 187, 188
 - Opening fully 188
 - Opening with SmartKey 188
 - Stopping 188
 - Synchronizing power windows 189
- Signal strength (telephone*) 138
- Simultaneous wiping and washing
 - Windshield wipers 48
- Single wipe 48
- Ski sack* 212
 - Removing 215
 - Unfolding and loading 212
 - Unloading and folding 214
- Sliding/pop-up roof 190
 - Closing 190, 314
 - Closing with KEYLESS-GO* 189, 192
 - Closing with SmartKey 191
 - Opening 190, 314
 - Opening with SmartKey 191
 - Stopping 191
 - Synchronizing 192, 315
- Sliding/pop-up roof*
 - Closing with KEYLESS-GO* 91
- SmartKey
 - Changing battery 312
 - Global locking and unlocking 85
 - Locking and unlocking 84
 - Opening and closing the sliding/pop-up roof with 191
 - Opening and closing windows with 188
 - Unlocking with 30
- SmartKey with KEYLESS-GO*
 - Changing battery 312
 - Checking the batteries 86
 - Global locking and unlocking 89, 90
 - Locking the vehicle 91
 - Loss of 91
 - Messages in display 288
 - Remote controls 88
 - Restoring to factory setting 85
 - Unlocking with 32
- Snow chains 265
- Soft keys
 - Audio system 168
- Spare fuses 338
- Spare parts service 340
- Speed
 - Resetting stored speed in Distronic* 202
 - Saving current 194
- Speed settings
 - Cruise control 195
 - Distronic* 201, 202

- Speedometer 23
 - Displaying gear range 143
 - Displays 198
 - Settings units 126
- Speedometer display mode
 - Selecting 126
- Speedshift
 - Downshifting 148
 - Upshifting 147
- Speedshift, CLK 55 AMG 146
- Split rear bench seat 215
- SRS 64, 365
 - Indicator lamp 278
- Standing lamps 105
 - Replacing bulbs 317, 319, 321
- Standing water
 - Driving instructions 247
- Starter switch 21, 31
 - Positions 31
- Starting difficulties 44
- Starting position 31
- Starting the engine 43
- Station (radio)
 - Search 120
- Station selection
 - Setting 132
- Steering column
 - Height adjustment 38
 - Length adjustment 38
- Steering gear oil
 - Message in display 300
- Steering wheel
 - Adjusting 37
 - Buttons 24
 - Cleaning 273
 - Electrical adjustment 37
 - Height adjustment 38
- Steering wheel gearshift control
 - Downshifting 148
 - Upshifting 147
- Steering wheel gearshift control (Speedshift), CLK 55 AMG 146
- Stolen vehicle
 - Tracking services 235
- Stopping
 - Sliding/pop-up roof 191
 - Windows 188
- Storage bags 222
- Storage compartments
 - Glove box 219
- Storage spaces
 - Cup holder 220, 221
- Storing (Memory function)
 - Positions into memory 103
- Submenus
 - Convenience 133
 - For settings 116
 - In control system 118
 - Instrument cluster 126, 128
 - Lighting 129
 - Resetting functions in Control system 124
 - Selecting 124
 - Settings menu 124
 - Vehicle 132
- Sun visors 152
- Supplemental Restraint System (SRS) 365
- Switching off
 - Audio system 168
 - Automatic central locking (control system) 133
 - Engine 51
 - ESP 78
 - Hazard warning flasher 108
 - Headlamps 51
 - Seat heating 101

Switching on

- Audio system 168
- Automatic central locking (control system) 133
- ESP 78
- Front fog lamps 107
- Front lamps 105
- Hazard warning flasher 108
- Headlamps 46
- High beams 108
- Parking lamps 105
- Rapid seat heating* 101
- Rear fog lamp 107
- Seat heating* 101
- Windshield wipers 47

Symbol (Distronic*)

- Distance warning function* 122

Synchronizing

- Power windows 189
- Sliding/pop-up roof 192, 315

T

- Tachometer 23, 113
 - Overspeed range 113
- Tail lamps
 - Cleaning 271
 - Replacing bulbs 317, 322
- Tar stains 269
- Technical data 353
 - Brake fluid 353
 - Coolant 351
 - Coolants 355
 - Electrical system 348
 - Engine 344
 - Engine oil 353
 - Engine oil additives 353
 - Fuel requirements 354
 - Fuels 351
 - Gasoline additives 354
 - Lubricants 351
 - Main dimensions 349
 - Premium unleaded gasoline 354
 - Rims and tires 345

Weights 350

- Windshield and headlamp washer system 357
- Windshield and headlamp* washer system 352

Tele Aid

- Information 232
- Initiating an emergency call manually 230
- Messages in display 301
- Roadside assistance 231
- Tele Aid System 227

Tele Aid System 366

Tele Aid* 227

- Emergency calls 228
- Remote door unlock 234
- Stolen vehicle tracking services 235
- System self-check 228
- Upgrade signals 233

Telematics* 366

Telephone

- Emergency call 185

- Telephone* 24, 226
 - Answering a call 139
 - Dialing a number from the phone book 139
 - Ending a call 139
 - Hands-free microphone 27
 - Loading phone book* 139
 - Messages in display 301
 - Operating 138
 - Operation 182
 - Redialing 140
- Temperature
 - Display mode 126
 - Grades of tires 359
 - Setting interior temperature 157
 - Setting units in display 126
 - Tires 262
- Tie-down rings (Trunk) 218
- Tightening torque 366
- Tightening torque (Wheel bolts) 328
- Time
 - Setting hours 128
 - Setting minutes 129
- Tire inflation pressure
 - Checking 252, 262
- Tire speed rating 245, 366
- Tire traction 245
- Tires 260, 345
 - Consumer information 358
 - Direction of rotation 261
 - Driving instructions 244
 - Retreads 260
 - Rims and tires 345
 - Service life 261
 - Temperature 262
 - Temperature grades 359
 - Tread depth 264
 - Wear pattern 263
 - Winter 264
- Tools 305
- Tow-away alarm 25, 81
 - Arming 81
 - Disarming 81
 - Disarming for transport 81
- Towing eye bolt (vehicle tool kit)
 - Installing 336
- Towing the vehicle 334
- Tracking services
 - For stolen vehicle 235
- Traction 145, 358, 366
- Transmission see Automatic transmission 256
- Transmission selector lever 313
 - Unlocking manually 313
- Traveling abroad 247
- Tread depth (tires) 264
- Tread wear 358
- Trip computer 136
- Trip odometer
 - Resetting 112
- Trunk
 - Auxiliary fuse box 338
 - Closing 94
 - Lock button, KEYLESS-GO* 91
 - Locking separately 94
 - Message in display 301
 - Opening 87
 - Opening from inside vehicle 92
 - Tie-down rings 218
 - Trunk lid 87
 - Trunk lock 311
 - Unlocking in an emergency 311
 - Unlocking separately 95
 - Unlocking with KEYLESS-GO* 90
 - Unlocking with SmartKey 86
- Trunk lid emergency release 93
- Turn signal lamps
 - Replacing bulbs 317

Turn signals 47

- Additional in mirrors 317
- Cleaning lenses 271
- Front bulbs 317, 319, 321
- Indicator lamps 23
- Rear bulbs 317, 322

Turning off

- Engine 51

U

Units

- Setting speedometer units 126
- Setting temperature units 126

Unlocking 30, 84

- Driver's door in an emergency 310
- Fuel filler flap 251
- Global 85
- Global with KEYLESS-GO* 89
- In an emergency 310
- Selective settings 85
- Transmission selector lever manually 313
- Trunk in an emergency 311
- Trunk lid with KEYLESS-GO* 90
- Trunk lid with SmartKey 86
- Trunk lid, separately 95
- Vehicle in an emergency 234

With KEYLESS-GO* 32

With the SmartKey 30

Upgrade signals

Tele Aid* 233

Uphill driving

Cruise control 194

Upshifting

- One-touch gearshifting 142
- Steering wheel gearshift control 147

Useful features 219

- Ashtrays 223
- Cigarette lighter 224
- Floormats* 225
- Garage door opener 235
- Interior storage spaces 219
- Tele Aid* 227
- Telephone* 226

V

Vehicle

- Individual settings 123, 125
- Locking 25
- Locking in an emergency 311
- Lowering 328
- Proper use of 16
- Service battery 329
- Towing 334

Unlocking 25

Unlocking in an emergency 310

Vehicle battery 329

Vehicle care 268

- Cup holder 273
- Distronic* system sensor cover 271
- Engine cleaning 270
- Gear selector lever 273
- Hard plastic trim items 273
- Headlamps 271
- Instrument cluster 273
- Leather upholstery 273
- Light alloy wheels 272
- Ornamental moldings 271
- Paintwork 270
- Parktronic* system sensor 272
- Plastic and rubber parts 273
- Power washer 269
- Seat belts 273
- Steering wheel 273
- Tail lamps 271
- Tar stains 269
- Turn signals 271
- Vehicle washing 270
- Window cleaning 272
- Wiper blades 272

- Vehicle jack 306
- Vehicle lighting
 - Checking 252
- Vehicle tool kit 305
 - Alignment bolt 305
 - Spare fuses 305
 - Special fuse puller 305
 - Towing eye bolt 305
 - Vehicle jack 305
 - Wheel bolts 305
 - Wheel wrench 305
- Vehicle washing 270
- VIN (Vehicle Identification Number) 366
- Voice control system* 366
- Voice control system*
 - Hands-free microphone 27

W

- Warning lamps see Lamps, indicator and warning
- Warning sounds
 - Distance warning function* 204
 - Distronic* 198
 - Drivers seat belts 62
 - Parking brake 45
- Warranty coverage 341
- Washer fluid see Windshield washer fluid

- Washing the vehicle 268
- Wear pattern (tires) 263
- Weights 350
- Wheel change
 - Tightening torque 328
- Wheels
 - Rotating 263
 - Tires and wheels 260
- Window curtain airbags 61
- Windows see Side windows
- Windshield
 - Defogging 158
 - Refilling washer fluid 259
 - Replacing wiper blades 323
 - Washer fluid 259, 357
 - Washer system 357
- Windshield washer fluid 357
 - Message in display 301
 - Mixing ratio 357
 - Refilling 259
 - Wiping with 48
- Windshield washer system 357
- Windshield wipers 47, 151
 - Fast wiper speed 48
 - Intermittent wiping 48
 - Replacing wiper blades 323

- Single wipe 48
- Switching on 47
- Wiping with windshield washer fluid 48

Winter driving 264

- Block heater* 265
- Snow chains 265
- Tires 264
- Transmission program mode 145, 147

Winter driving instructions 246

Winter tires 264

Wiper blades

- Cleaning 272
- Installing 323
- Removing 323
- Replacing 323

Wiping

- And washing simultaneously 48
- Interval 48
- With windshield washer fluid 48

X

- Xenon headlamps
 - Bi-Xenon 361

Service and Literature

Your authorized Mercedes-Benz Center has trained technicians and original Mercedes-Benz parts to service your vehicle properly. For expert advice and quality service, see your authorized Mercedes-Benz Center.

If you are interested in obtaining service literature for your vehicle, please contact your authorized Mercedes-Benz Center. We consider this the best way for you to obtain accurate information for your vehicle.

For further information you can find us on the Mercedes-Benz web-site *www.mbusa.com* or *www.mercedes-benz.ca*.

Warning!



To help avoid personal injury, be extremely careful when performing any service work or repairs. Improper or incomplete service or the use of incorrect or inappropriate parts or materials may damage the vehicle or its equipment, which may in turn result in personal injury.

If you have any question about carrying out some service, turn to the advice of an authorized Mercedes-Benz Center.

We reserve the right to modify the technical details of the vehicle as given in the data and illustrations of this Operator's Manual. Re-printing, translation and copying, even of excerpts, is not permitted without our prior authorization in writing.

Title illustration no. P00.01-2353-31

Date to press 10 / 25 / 02

GSP/SIP

Printed in Germany

