



2095849883

Order No. 6515 1298 13 Part No. 209 584 98 83 USA Edition A 2006

Operator's Manual CLK-Class Cabriolet



Operator's Manual
CLK-Class Cabriolet



Mercedes-Benz

CLK 350

CLK 500

CLK 55 AMG

Our company and staff congratulate you on the purchase of your new Mercedes-Benz.

Your selection of our product is a demonstration of your trust in our company name. Furthermore, it exemplifies your desire to own an automobile that will be as easy as possible to operate and provide years of service.

Your Mercedes-Benz represents the efforts of many skilled engineers and craftsmen. To help assure your driving pleasure, and also the safety of you and your passengers, we ask you to make a small investment of time:

- Please read this manual carefully, then return it to your vehicle where it will be handy for your reference.
- Please follow the recommendations contained in this manual. They are designed to acquaint you with the operation of your Mercedes-Benz.
- Please pay attention to the warnings and cautions contained in this manual. They are designed to help improve the safety of the vehicle operator and occupants.

We extend our best wishes for many miles of safe, pleasurable driving.

Mercedes-Benz USA, LLC
A DaimlerChrysler Company

Introduction	9
Product information	9
Operator's Manual	10
Service and warranty information ..	10
Important notice for California retail buyers and lessees of Mercedes-Benz automobiles	11
Maintenance	12
Roadside Assistance	12
Change of address or ownership....	12
Operating your vehicle outside the USA or Canada	13
Where to find it	14
Symbols	15
Operating safety	16
Proper use of the vehicle	16
Problems with your vehicle	17
Reporting safety defects	18
Reporting safety defects	18
Vehicle data recording	19
Information regarding electronic recording devices	19

At a glance	21
Cockpit	22
Instrument cluster	24
Multifunction steering wheel	26
Center console	27
Upper part	27
Lower part	28
Overhead control panel	29
Door control panel	30

Getting started	31
Unlocking	32
Unlocking with the SmartKey	32
Unlocking with KEYLESS-GO*	33
Starter switch positions	34
Adjusting	37
Seats	37
Steering wheel	41
Easy-entry/exit feature	42
Mirrors	43
Driving	45
Fastening the seat belts	45
Starting the engine	48
Parking brake	50
Driving	51
Switching on headlamps	52
Turn signals	53
Windshield wipers	53
Problems while driving	56
Parking and locking	57
Parking brake	57
Switching off headlamps	58
Turning off the engine	58
Releasing seat belts	59
Locking	59

Safety and Security	61	Controls in detail	95	Lighting	127
Occupant safety	62	Locking and unlocking	96	Exterior lamp switch	127
Air bags	63	SmartKey	96	Combination switch	131
Seat belts	69	SmartKey with KEYLESS-GO*	100	Corner-illuminating front	
Active head restraints	73	Opening the doors		fog lamps* (CLK with	
Roll bars	74	from the inside	107	Bi-Xenon* headlamps)	132
Children in the vehicle	75	Opening the trunk	108	Hazard warning flasher	133
Blocking of rear side		Closing the trunk	110	Interior lighting	134
window operation	85	Trunk emergency release	115	Door entry lamps	135
Panic alarm	86	Valet locking	116	Trunk lamp	135
Activating	86	Automatic central locking	117	Instrument cluster	136
Deactivating	86	Locking and unlocking		Instrument cluster illumination	136
Driving safety systems	87	from the inside	118	Coolant temperature indicator	137
ABS	87	Seats	119	Trip odometer	137
BAS	88	Front seat active head restraints .	119	Tachometer	138
ESP®	89	Rear seat head restraints	119	Outside temperature indicator	138
Anti-theft systems	92	Multicontour seat*	121	Control system	139
Immobilizer	92	Seat heating*	122	Multifunction display	140
Anti-theft alarm system	92	Seat ventilation*	123	Multifunction steering wheel	140
Tow-away alarm	94	Memory function	124	Menus	142
		Storing positions into memory	125	Standard display menu	144
		Recalling positions from memory .	125	AUDIO menu	145
		Storing exterior rear view		NAV* menu	146
		mirror parking position	126	Vehicle status	
				message memory menu	146
				Settings menu	148

Trip computer menu.....	161	Adjusting air distribution.....	190	Audio system.....	209
TEL menu*	163	Adjusting air volume	191	Audio and telephone*, operation..	209
Automatic transmission.....	166	Front defroster.....	191	Operating safety	209
Gear selector lever position	168	Air recirculation mode	192	Sound system*	209
Driving tips.....	170	Air conditioning.....	194	Operating and display elements ...	210
Gear ranges	171	Rear passenger compartment		Button and soft key operation	212
Automatic shift program	172	adjustable air vents.....	195	Operation.....	212
Gear selector lever		Automatic climate control		Radio operation	217
one-touch gearshifting	173	(CLK 500/CLK 55 AMG).....	196	Introduction to satellite radio*	
Steering wheel gearshift		Deactivating the		(USA only).....	222
control one-touch gearshifting	174	automatic climate control system.	199	CD mode.....	227
Manual shift program		Operating the climate control system in		GSM network phones	233
CLK 55 AMG	178	automatic mode.....	199	TDMA or CDMA network phones ..	240
Emergency operation		Setting the temperature.....	200	Emergency calls “911”	247
(Limp Home Mode)	180	Adjusting air distribution.....	200	Power windows	249
Good visibility	181	Adjusting air volume	201	Opening and	
Headlamp cleaning system*	181	Front defroster.....	201	closing the windows	249
Rear view mirrors	181	Maximum cooling MAXCOOL	202	Synchronizing power windows.....	251
Sun visors	184	Air recirculation mode	203	Summer opening feature	252
Rear window defroster	185	Charcoal filter	204	Convenience closing feature.....	253
Climate control (CLK 350)	186	Air conditioning.....	206	Opening and closing all side	
Deactivating the		Residual heat and ventilation*		windows with the soft top switch .	254
climate control system.....	189	(Canada only).....	207	Soft top	255
Operating the climate control		Rear passenger compartment		Opening and closing the soft top..	255
system in automatic mode.....	189	adjustable air vents.....	208	Opening and closing the	
Setting the temperature.....	190			soft top with the SmartKey	260

Contents

Luggage cover.....	262		
Wind screen	263		
Driving systems	265		
Cruise control.....	265		
Parktronic system (Parking assist)*, Canada only	269		
Loading.....	273		
Ski sack* (Canada only)	273		
Loading instructions.....	277		
Useful features	278		
Storage compartments.....	278		
Center armrest.....	281		
Armrest in the rear passenger compartment.....	283		
Cup holders.....	283		
Ashtrays	284		
Cigarette lighter	286		
Power outlet in the rear passenger compartment.....	287		
Floormats*	287		
Telephone*	288		
Tele Aid	289		
Garage door opener*	296		
Operation	305		
The first 1000 miles (1500 km).....	306		
Driving instructions.....	307		
Drive sensibly – save fuel.....	307		
Drinking and driving	307		
Pedals	307		
Power assistance	307		
Brakes.....	308		
Driving off	310		
Parking.....	310		
Tires	311		
Hydroplaning.....	311		
Tire traction.....	312		
Tire speed rating	312		
Winter driving instructions	313		
Standing water	314		
Passenger compartment	314		
Driving abroad.....	315		
Control and operation of radio transmitters	315		
Catalytic converter.....	316		
Emission control	316		
Coolant temperature	317		
		At the gas station	318
		Refueling.....	318
		Check regularly and before a long trip.....	320
		Engine compartment	321
		Hood	321
		Engine oil	322
		Transmission fluid level.....	326
		Coolant	327
		Battery	328
		Windshield washer system and headlamp cleaning system*	329
		Tires and wheels.....	330
		Important guidelines	330
		Tire care and maintenance.....	331
		Direction of rotation.....	333
		Loading the vehicle	333
		Recommended tire inflation pressure.....	339
		Checking tire inflation pressure ...	341
		MOExtended system*	345
		Tire labeling	345
		Load identification	349
		DOT, Tire Identification Number (TIN)	350
		Maximum tire load	351

Maximum tire inflation pressure ..	352		
Uniform Tire Quality Grading Standards (U.S. vehicles)	353		
Tire ply material	354		
Tire and loading terminology	355		
Rotating tires	358		
Winter driving	359		
Winter tires	359		
Block heater (Canada only)	360		
Snow chains	360		
Maintenance	361		
Maintenance service indicator message	361		
Clearing the maintenance service indicator message	362		
Maintenance service term exceeded	362		
Calling up the maintenance service indicator display	362		
Resetting the maintenance service indicator	363		
Vehicle care	364		
Cleaning and care of vehicle	364		
		Practical hints	373
		What to do if ...?	374
		Lamps in instrument cluster	374
		Lamp in center console	381
		Vehicle status messages in the multifunction display	383
		Where will I find...?	413
		First aid kit	413
		Vehicle tool kit	413
		Minispare wheel	416
		Spare wheel bolts	418
		Unlocking/locking in an emergency ...	419
		Unlocking the vehicle	419
		Locking the vehicle	420
		Fuel filler flap	421
		Manually unlocking the gear selector lever	422
		Opening/closing in an emergency	423
		Operating roll bars manually	423
		Soft top emergency operation	425
		Resetting activated head restraints ...	434
		Resetting activated head restraints	434
		Replacing SmartKey batteries	435
		SmartKey	436
		SmartKey with KEYLESS-GO*	437
		Replacing bulbs	438
		Bulbs	438
		Replacing bulbs for front lamps	440
		Replacing bulbs for rear lamps	443
		Replacing wiper blades	444
		Removing and installing wiper blades	444
		Flat tire	446
		Preparing the vehicle	446
		Mounting the Minispare wheel	447
		MOExtended system*	452
		Battery	453
		Disconnecting the battery	454
		Removing the battery	454
		Charging and reinstalling the battery	455
		Reconnecting the battery	455
		Jump starting	456

Contents

Towing the vehicle	458				Fuels, coolants, lubricants, etc.	479
Towing the vehicle.....	458				Capacities	479
Installing towing eye bolt.....	460				Engine oils	481
Fuses	462				Engine oil additives	481
Aids for replacing fuses.....	462				Air conditioning refrigerant	481
Mainfuse box in passenger					Brake fluid.....	481
compartment.....	463				Premium unleaded gasoline.....	482
Fuse box in engine compartment .	463				Fuel requirements.....	482
Fuse box in trunk.....	464				Gasoline additives.....	483
					Coolants	484
					Windshield washer system and	
					headlamp cleaning system*	486
					Technical terms	487
					Index	493

▼ Product information

Please observe the following in your own best interest:

We recommend using Genuine Mercedes-Benz parts as well as conversion parts and accessories explicitly approved by us for your vehicle model.

We have tested these parts to determine their reliability, safety and special suitability for Mercedes-Benz vehicles.

We are unable to make an assessment for other products and therefore cannot be held responsible for them, even if in individual cases an official approval or authorization by governmental or other agencies should exist. Use of such parts and accessories could adversely affect the safety, performance or reliability of your vehicle. Please do not use them.

Genuine Mercedes-Benz parts as well as conversion parts and accessories approved by us are available at your authorized Mercedes-Benz Center where you will receive comprehensive information, also on permissible technical modifications, and where proper installation will be performed.

Operator's Manual

This Operator's Manual contains a great deal of useful information. We urge you to read it carefully and familiarize yourself with the vehicle before driving.

For your own safety and longer service life of the vehicle, we urge you to follow the instructions and warnings contained in this manual. Ignoring them could result in damage to the vehicle or personal injury to you or others. Vehicle damage caused by failure to follow instructions is not covered by the Mercedes-Benz Limited Warranty.

Your vehicle may have some or all of the equipment described in this manual. Therefore, you may find explanations for optional equipment not installed in your vehicle. If you have any questions about the operation of any equipment, your authorized Mercedes-Benz Center will be glad to demonstrate the proper procedures.

We continuously strive to improve our product, and ask for your understanding that we reserve the right to make changes in design and equipment. Therefore, information, illustrations and descriptions in this Operator's Manual might differ from your vehicle.

Optional equipment is also described in this manual, including operating instructions wherever necessary. Since they are special-order items, the descriptions and illustrations herein may vary slightly from the actual equipment of your vehicle.

If there are any equipment details that are not shown or described in this Operator's Manual, your authorized Mercedes-Benz Center will be glad to inform you of correct care and operating procedures. The Operator's Manual and Maintenance Booklet are important documents and should be kept with the vehicle.

Service and warranty information

The Service and Warranty Information Booklet contains detailed information about the warranties covering your Mercedes-Benz, including:

- New Car Limited Warranty,
- Emission System Warranty,
- Emission Performance Warranty,
- California, Maine, Massachusetts, and Vermont Emission Control System Warranty (California, Maine, Massachusetts, and Vermont only),
- State Warranty Enforcement Laws (Lemon Laws).

Important notice for California retail buyers and lessees of Mercedes-Benz automobiles

Under California law you may be entitled to a replacement of your vehicle or a refund of the purchase price or lease price, if Mercedes-Benz USA, LLC and / or its authorized repair or service facilities fail to fix one or more substantial defects or malfunctions in the vehicle that are covered by its express warranty after a reasonable number of repair attempts. During the period of 18 months from original delivery of the vehicle or the accumulation of 18000 miles (approx. 29000 km) on the odometer of the vehicle, whichever occurs first, a reasonable number of repair attempts is presumed for a retail buyer or lessee if one or more of the following occurs:

- (1) the same substantial defect or malfunction results in a condition that is likely to cause death or serious bodily injury if the vehicle is driven, that defect or malfunction has been subject to repair two or more times, and you have directly notified Mercedes-Benz USA, LLC in writing of the need for its repair,
- (2) the same substantial defect or malfunction of a less serious nature than category (1) has been subject to repair four or more times and you have directly notified us in writing of the need for its repair, or
- (3) the vehicle is out of service by reason of repair of the same or different substantial defects or malfunctions for a cumulative total of more than 30 calendar days.

Written notification should be sent to us, not a dealer, at Mercedes-Benz USA, LLC, Customer Assistance Center, One Mercedes Drive, Montvale, NJ 07645-0350.

Maintenance

The Maintenance Booklet describes all the necessary maintenance work which should be performed at regular intervals.

Always have the Maintenance Booklet with you when you take the vehicle to your authorized Mercedes-Benz Center for service. The service advisor will record each service in the booklet for you.

Roadside Assistance

The Mercedes-Benz Roadside Assistance Program provides factory trained technical help in the event of a breakdown. Calls to the toll-free Roadside Assistance number

1-800-FOR-MERCEdes (in the USA)
1-800-387-0100 (in Canada)

will be answered by Mercedes-Benz Customer Assistance Representatives 24 hours a day, 365 days a year.

For additional information refer to the Mercedes-Benz Roadside Assistance Program Brochure in your vehicle literature portfolio.

Change of address or ownership

If you change your address, be sure to send in the "Change of Address Notice" found in the Service and Warranty Information Booklet, or simply call the Mercedes-Benz Customer Assistance Center (in the USA) at 1-800-FOR-MERCEdes, or Customer Service (in Canada) at 1-800-387-0100. It is in your own interest that we can contact you should the need arise.

If you sell your Mercedes, please leave all literature with the vehicle to make it available to the next operator.

If you bought this vehicle used, be sure to send in the "Notice of Purchase of Used Car" found in the Service and Warranty Information Booklet, or call the Mercedes-Benz Customer Assistance Center (in the USA) at 1-800-FOR-MERCEdes, or Customer Service (in Canada) at 1-800-387-0100.

Operating your vehicle outside the USA or Canada

If you plan to operate your vehicle in foreign countries, please be aware that:

- service facilities or replacement parts may not be readily available,
- unleaded gasoline for vehicles with catalytic converters may not be available; the use of leaded fuels will damage the catalyts,
- gasoline may have a considerably lower octane rating, and improper fuel can cause engine damage.

Certain Mercedes-Benz models are available for delivery in Europe under our European Delivery Program. For details, consult an authorized Mercedes-Benz Center or write to:

In the USA:

Mercedes-Benz USA, LLC
European Delivery Department
One Mercedes Drive
Montvale, NJ 07645-0350

In Canada:

Mercedes-Benz Canada Inc.
European Delivery Department
98 Vanderhoof Avenue
Toronto, Ontario M4G 4C9

Where to find it

This Operator's Manual is designed to provide comprehensive support information for you, the vehicle operator. Each section has its own reference color.

At a glance

Here you will find an overview of all the controls that can be operated from the driver's seat.

Getting started

Here you will find all the information you need for your first drive. You should read this section first if this is your first Mercedes-Benz vehicle or if you are renting or borrowing this vehicle.

Safety and Security

Here you will find descriptions of the safety and security features of your vehicle.

Controls in detail

Here you will find detailed information about the equipment installed in your vehicle. This section expands on the "Getting started" section and also describes technical innovations. If you are already familiar with the basic functions of your vehicle, this section will be of particular interest to you.

Operation

Here you will find all the information you need for the proper operation of your vehicle.

Practical hints

This section provides fast assistance for dealing with problems you may encounter.

Technical data

All important technical data for your vehicle can be found in this section.

Indexes

The glossary provides explanations of the most important technical terms.

The table of contents and the index are designed to help you find information quickly and easily.

The following publications are part of your vehicle documentation:

- this Operator's Manual
- the Maintenance Booklet

Separate operating instructions will be provided as required depending on the equipment options installed in your vehicle.

▼ Symbols

Trademarks:

- ESP® is a registered trademark of DaimlerChrysler.
- HomeLink® is a registered trademark of Prince, a Johnson Controls Company.
- SIRIUS and related marks are trademarks of Sirius Satellite Radio Inc.

The following symbols are found in this Operator's Manual:

- * Optional equipment is identified with an asterisk. Since standard equipment varies between models, the descriptions and illustrations in this manual may differ slightly from the actual equipment of your vehicle.

Warning!



Warning notices draw your attention to hazards that may endanger your health or life, or the health or life of others.



Highlights hazards that may result in damage to your vehicle.



Helpful hints or further information you may find useful.

- ▶ This symbol points to instructions for you to follow.
- ▶ A number of these symbols appearing in succession indicates a multiple-step procedure.
 - ▷ Page This symbol tells you where to look for further information on a topic.
 - ▷▷ This continuation symbol marks an interrupted procedure which will be continued on the next page.
 - > In the glossary of technical terms, this symbol is used to indicate cross-references to term definitions.
- Display Words appearing in the multi-function display are printed in the type shown here.

Warning!



Work improperly carried out on electronic components and associated software could cause them to cease functioning. Because the vehicle's electronic components are interconnected, any modifications made may produce an undesired effect on other systems. Electronic malfunctions could seriously impair the operating safety of your vehicle.

See an authorized Mercedes-Benz Center for repairs or modifications to electronic components.

Other improper work or modifications on the vehicle could also have a negative impact on the operating safety of the vehicle.

Some safety systems only function while the engine is running. You should therefore never turn off the engine while driving.

Warning!



Heavy blows against the vehicle underbody or tires / wheels, for example when running over an obstacle, road debris or a pothole, may cause serious damage to and impair the operating safety of your vehicle. If you feel a sudden significant vibration or ride disturbance, or you suspect that damage to your vehicle has occurred, you should turn on your hazard warning flashers, carefully slow down, and drive with caution to an area which is a safe distance from the road.

Inspect the vehicle underbody and tires / wheels for possible damage. If the vehicle appears unsafe, have it towed to the nearest authorized Mercedes-Benz Center or other qualified maintenance or repair facility for further inspection or repairs.

Proper use of the vehicle

Proper use of the vehicle requires that you are familiar with the following information and rules:

- the safety precautions in this manual
- the “Technical data” section in this manual
- traffic rules and regulations
- motor vehicle laws and safety standards

Warning!



Various warning labels are attached to your vehicle. These warning labels are intended to make you and others aware of various risks. You should not remove any of these warning labels unless explicitly instructed to do so by information on the label itself. Removal of any of these labels may cause you and others to be unaware of certain risks which may result in an accident and/or personal injury.

▼ Problems with your vehicle

If you should experience a problem with your vehicle, particularly one that you believe may affect its safe operation, we urge you to immediately contact an authorized Mercedes-Benz Center to have the problem diagnosed and corrected if required. If the matter is not handled to your satisfaction, please discuss the problem with the Mercedes-Benz Center management, or if necessary contact us at one of the following addresses:

In the USA:

Customer Assistance Center
Mercedes-Benz USA, LLC
One Mercedes Drive
Montvale, NJ 07645-0350

In Canada:

Customer Relations Department
Mercedes-Benz Canada Inc.
98 Vanderhoof Avenue
Toronto, Ontario M4G 4C9

Reporting safety defects

For the USA only:

The following text is published as required of manufacturers under Title 49, Code of U.S. Federal Regulations, Part 575 pursuant to the “National Traffic and Motor Vehicle Safety Act of 1966”.

Reporting safety defects

If you believe that your vehicle has a defect which could cause a crash or could cause injury or death, you should immediately inform the National Highway Traffic Safety Administration (NHTSA) in addition to notifying Mercedes-Benz USA, LLC.

If NHTSA receives similar complaints, it may open an investigation, and if it finds that a safety defect exists in a group of vehicles, it may order a recall and remedy campaign. However, NHTSA cannot become involved in individual problems between you, your dealer, or Mercedes-Benz USA, LLC.

To contact NHTSA, you may either call the Auto Safety Hotline toll-free at 1-888-327-4236 (or 366-0123 in Washington, D.C. area) or write to: NHTSA, U.S. Department of Transportation, Washington, D.C. 20590. You can also obtain other information about motor vehicle safety from the Hotline.

▼ Vehicle data recording

Information regarding electronic recording devices

(Including notice pursuant to California Code § 9951)

Please note that your vehicle is equipped with devices that can record vehicle systems data and, if equipped with the Tele Aid system, may transmit some data in certain accidents.

This information helps, for example, to diagnose vehicle systems after a collision and to continuously improve vehicle safety. DaimlerChrysler may access the information and share it with others

- for safety research or vehicle diagnosis purposes
- with the consent of the vehicle owner or lessee
- in response to an official request by law enforcement or other government agency
- for use in dispute resolution involving DaimlerChrysler, its affiliates or sales/service organization and/or
- as otherwise required or permitted by law.

Please check the Tele Aid subscription service agreement for details regarding the information that may be recorded or transmitted via that system.

At a glance

Cockpit

Instrument cluster

Multifunction steering wheel

Center console

Overhead control panel

Door control panel



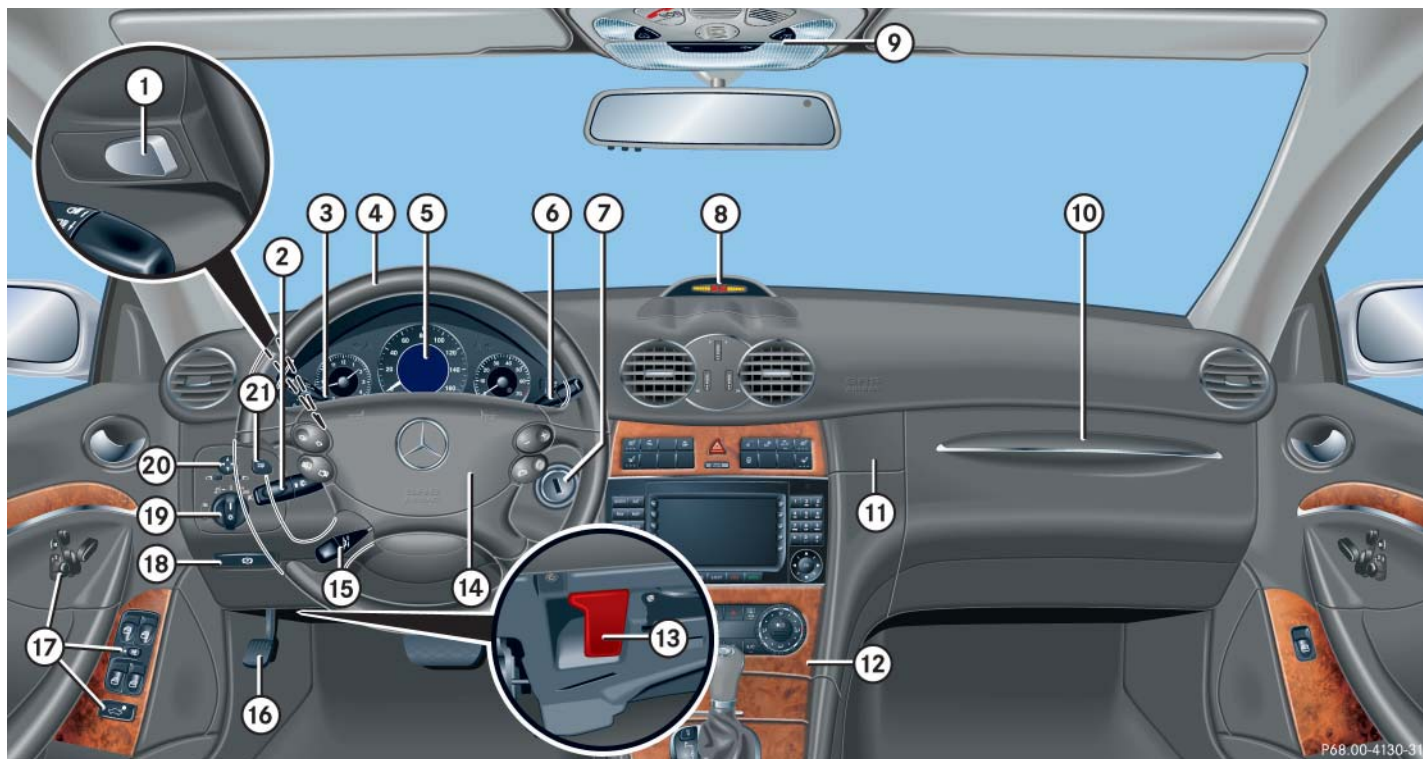

P68.00-4130-31





Item	Page
① Steering wheel gearshift buttons	
CLK 500	175
CLK 55 AMG	176
② Combination switch	
• Turn signals	53
• Windshield wipers	53
• High beam	52
③ Cruise control lever	265
④ Multifunction steering wheel	26, 140
⑤ Instrument cluster	24, 136
⑥ Lever for voice control system*, see separate operating instructions	
⑦ Starter switch	34
⑧ Front Parktronic* warning indicator (Canada only)	269

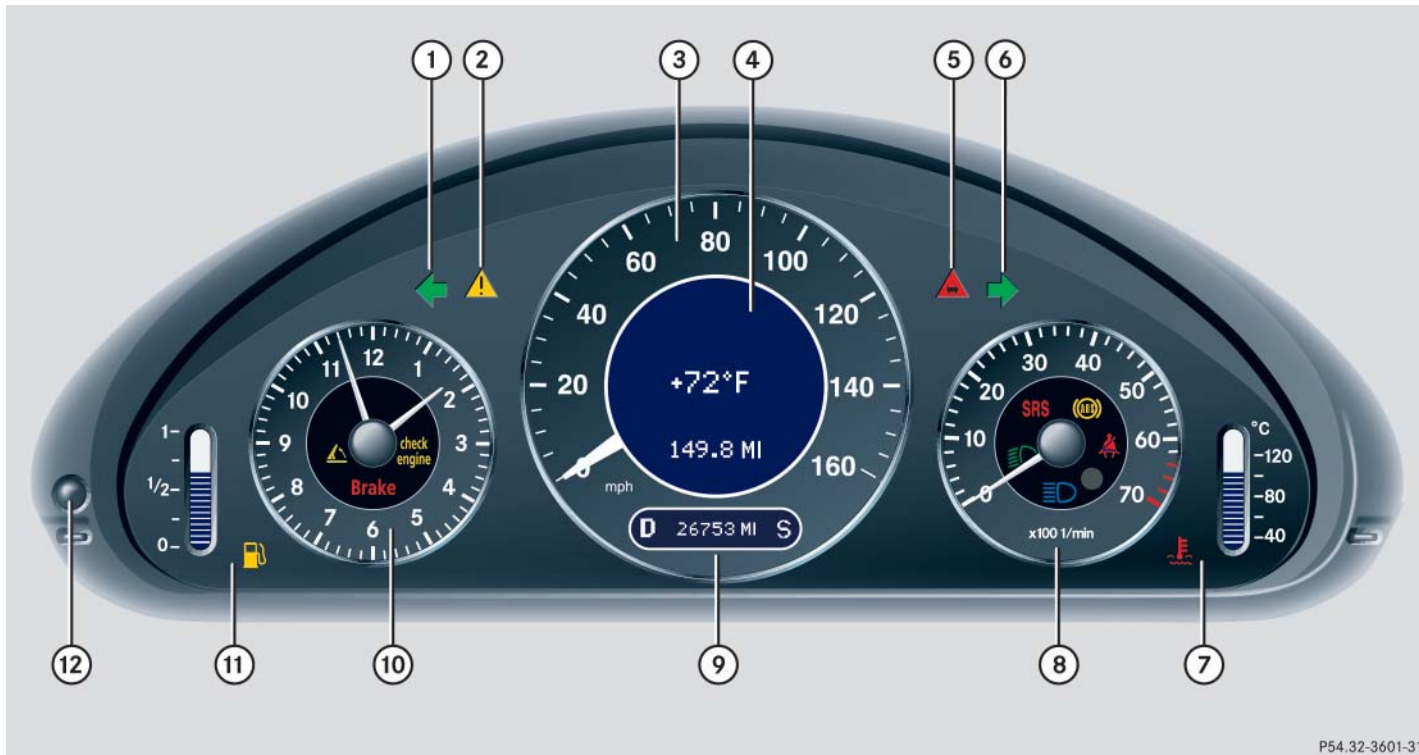



Item	Page
⑨ Overhead control panel	29
⑩ Glove box	278
⑪ Cup holder	283
⑫ Center console	27, 28
⑬ Hood lock release	321
⑭ Horn	
⑮ Steering wheel adjustment stalk	41
⑯ Parking brake pedal	50
⑰ Door control panel	30
⑱ Parking brake release	50
⑲ Exterior lamp switch	52, 127
⑳ Exterior rear view mirror adjustment	43
㉑ Headlamp washer switch*	181







Instrument cluster



P54.32-3601-31

	Item	Page
①	 Left turn signal indicator lamp	53
②	 ESP® warning lamp	378
③	Speedometer	
④	Multifunction display	140
⑤	 Distance warning lamp	
	Warning lamp without function. It illuminates with the ignition on. It should go out when the engine is running.	
⑥	 Right turn signal indicator lamp	53
⑦	Coolant temperature indicator with:	137
	 Coolant temperature warning lamp	377, 398





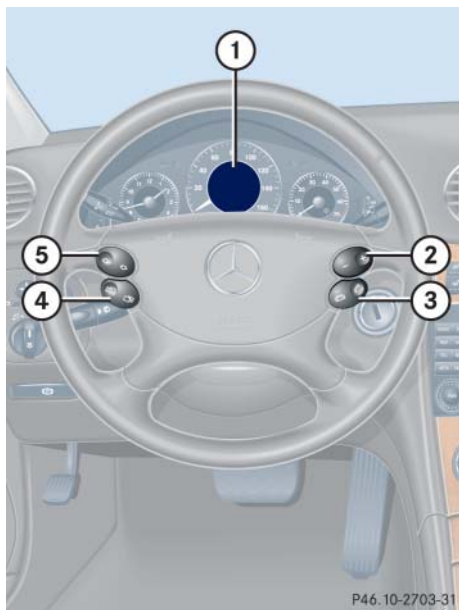

	Item	Page
⑧	Tachometer with:	138
	 Supplemental Restraint System (SRS) indicator lamp	380, 409
	 Antilock Brake System (ABS) indicator lamp	374
	 Seat belt telltale	71, 379
	 Low beam headlamp indicator lamp	131
	 High beam headlamp indicator lamp	131
⑨	Main odometer with:	
	• Gear selector lever position	140
	• Program mode	140





	Item	Page
⑩	Clock with:	153
	 Brake warning lamp, USA only	375
	 Brake warning lamp, Canada only	
	 Engine malfunction indicator lamp, USA only	376
	 Engine malfunction indicator lamp, Canada only	376
	 Roll bar warning lamp	
⑪	Fuel display with:	
	 Fuel reserve warning lamp	379
⑫	Reset button for:	
	• Resetting trip odometer	136
	• Adjusting instrument cluster illumination	136
	• Confirming new time settings	153

Multifunction steering wheel



P46.10-2703-31

Item	Page
① Multifunction display	140
Operating control system	140
② Selecting the submenu or setting the volume: Press button	
 up / to increase	
 down / to decrease	
③ Telephone*: Press button	
 to take a call	164
 to dial a call	164
 to end a call	164
 to reject an incoming call	

Item	Page
④ Menu systems: Press button	
 for next menu	
 for previous menu	
⑤ Moving within a menu: Press button	
 for next display	
 for previous display	

▼ Center console

Upper part



P68.20-3471-31

Item	Page
① Seat heater*, driver's side	122
Seat ventilation*, driver's side	123
② Parktronic system* deactivation switch (Canada only)	272
③ ESP® control switch	89
④ Hazard warning flasher switch - switching on/off	133
⑤ Central unlocking switch	118
Central locking switch	118
⑥ Switch for lowering rear seat head restraints	120
⑦ Tow-away alarm switch	94
Anti-theft alarm system indicator lamp	94

Item	Page
⑧ Seat heater*, passenger side	122
Seat ventilation*, passenger side	123
⑨ Front passenger front air bag off indicator lamp	81, 381
⑩ Audio system, or COMAND* (see separate operating instructions)	145
⑪ Climate control (CLK 350)	186
Automatic climate control (CLK 500/CLK 55 AMG)	196,
Rear window defroster	185

Center console

Lower part

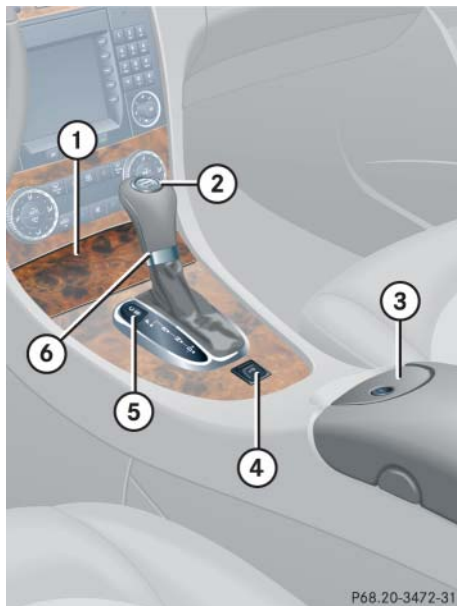

	Item	Page
①	Ashtray	284
	Cigarette lighter	286
②	KEYLESS-GO* start/stop button	35
③	Compartment in center armrest (depending on vehicle production date):	
	Design A (illustrated in the picture)	281
	Design B	282
④	Soft top switch	256
⑤	Program mode selector switch for automatic transmission	
	• Automatic shift program	172
	• Manual shift program (CLK 55 AMG)	179
⑥	Gear selector lever for automatic transmission	166

▼ Overhead control panel

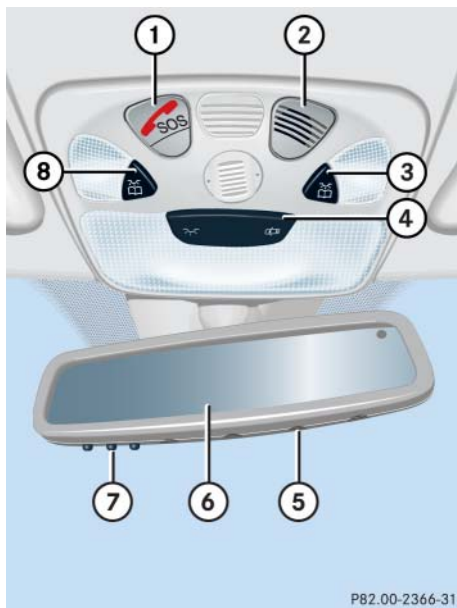

PB2.00-2366-31

Item	Page
① Tele Aid (emergency call system) button	289
② Temperature sensor for automatic climate control	
③ Right reading lamp on/off	135
④ Interior lighting control	134
⑤ Hands-free microphone for Tele Aid (emergency call system) and telephone*	288
⑥ Interior rear view mirror	43, 181
⑦ Garage door opener*	296
⑧ Left reading lamp on/off	135

Door control panel

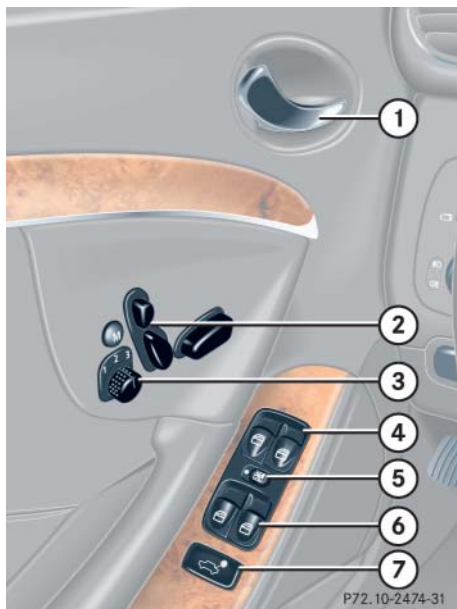

	Item	Page
①	Door handle	107
②	Seat adjustment	38, 119
③	Memory function (for storing seat, exterior mirror and steering wheel settings)	124
④	Switches for opening/closing front door windows	249
⑤	Rear window override switch	85
⑥	Switches for opening/closing rear windows	249
⑦	Remote trunk opening switch	109
	Remote trunk opening/closing* switch	109

Unlocking

Adjusting

Driving

Parking and locking



Unlocking



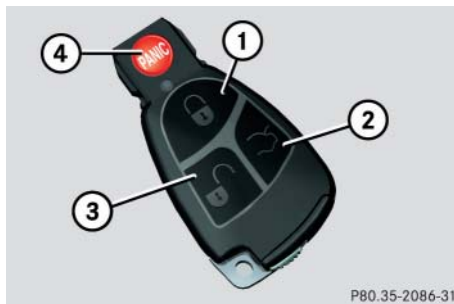

The “Getting started” section provides an overview of the vehicle’s most basic functions. First-time Mercedes-Benz owners should pay special attention to the information given here.

If you are already familiar with the basic functions described here, the “Controls in detail” section will provide you with further information. The corresponding page references are located at the end of each segment.

Unlocking with the SmartKey



SmartKey with remote control

- ①  Lock button
- ②  Opening button for trunk
- ③  Unlock button
- ④  PANIC button (▷ page 86)

- ▶ Press unlock button  on the SmartKey.

All turn signal lamps flash once. The locking knobs in the doors move up. The anti-theft alarm system is disarmed.

- ▶ Enter the vehicle and insert the SmartKey in the starter switch.

Warning!



When leaving the vehicle, always remove the SmartKey from the starter switch, take it with you, and lock the vehicle. Do not leave children unattended in the vehicle, or with access to an unlocked vehicle. Unsupervised use of vehicle equipment may cause an accident and/or serious personal injury.



Opening a door causes the windows on that side of the car to open slightly. They will return to the up position when the door is closed.

For more information, see “SmartKey” (▷ page 96).

Unlocking with KEYLESS-GO*

With the KEYLESS-GO function, you can lock and unlock the vehicle without using the remote control buttons on the SmartKey and start the engine without inserting the SmartKey in the starter switch.



To unlock the vehicle, the SmartKey with KEYLESS-GO must be outside the vehicle, no further than approx. 3 feet (1 meter) away from the door.

Warning!



When leaving the vehicle, always take the SmartKey with KEYLESS-GO with you, and lock the vehicle. Do not leave children unattended in the vehicle, or with access to an unlocked vehicle. Unsupervised use of vehicle equipment may cause an accident and/or serious personal injury.

- ▶ Pull an outside door handle.
All turn signal lamps flash once. The vehicle unlocks. The locking knobs in the doors move up. The anti-theft alarm system is disarmed.
- ▶ Enter the vehicle.



Opening a door causes the windows on that side of the car to open slightly. They will return to the up position when the door is closed.

For more information, see “SmartKey with KEYLESS-GO*” (▷ page 100).

Unlocking

Starter switch positions

Warning!



When leaving the vehicle, always remove the SmartKey or SmartKey with KEYLESS-GO* from the starter switch, take it with you, and lock the vehicle. Do not leave children unattended in the vehicle, or with access to an unlocked vehicle. Unsupervised use of vehicle equipment may cause an accident and/or serious personal injury.

SmartKey

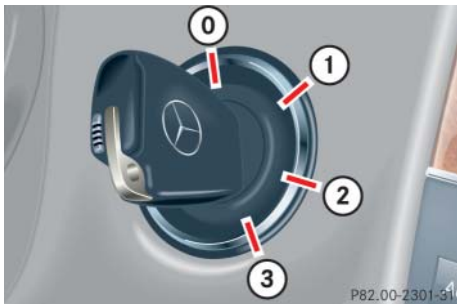

Starter switch

- 0 For removing SmartKey
The steering is locked when the SmartKey is removed from the starter switch.
- 1 Power supply for some electrical consumers, such as seat adjustment.
- 2 Ignition (power supply for all electrical consumers) and driving position. All lamps (except low beam headlamp indicator lamp, high beam headlamp indicator lamp, and turn signal indicator lamps unless activated) in the instrument cluster come on. If a lamp in the instrument cluster fails to come on when the ignition is switched on, have it checked and replaced if necessary. If a lamp in the instrument cluster remains on after starting the engine or comes on while driving, refer to “Lamps in instrument cluster” (▷ page 374).
- 3 Starting position.



When you switch on the ignition, the indicator and warning lamps (except low beam headlamp indicator lamp, high beam headlamp indicator lamp, and turn signal indicator lamps unless activated) in the instrument cluster come on. The indicator and warning lamps (except low beam headlamp indicator lamp, high beam headlamp indicator lamp, and turn signal indicator lamps if activated) will go out when the engine is running. This indicates that the respective systems are operational.



The SmartKey can only be removed from the starter switch with the gear selector lever in position **P**.



If the SmartKey cannot be turned in the starter switch, the battery may not be sufficiently charged.

- Check the battery and charge it if necessary (▷ page 453).
- Get a jump start (▷ page 456).

To prevent accelerated battery discharge or a completely discharged battery, always remove the SmartKey from the starter switch when the engine is not in operation.

For more information, see “SmartKey” (▷ page 96).

For information on starting the engine using the SmartKey, see “Starting with the SmartKey” (▷ page 49).

SmartKey with KEYLESS-GO*

Pressing the KEYLESS-GO start/stop button on the gear selector lever corresponds to turning the SmartKey to the various starter positions.

If you firmly depress the brake pedal during pressing the KEYLESS-GO start/stop button, the engine starts automatically.

You can also use the SmartKey with KEYLESS-GO like a normal SmartKey.



The function of the SmartKey overrules the KEYLESS-GO function.

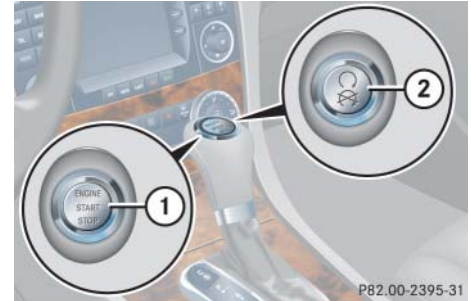

KEYLESS-GO start/stop button

- ① USA only
- ② Canada only

The SmartKey with KEYLESS-GO must be located in the vehicle.

- ▶ Make sure the gear selector lever is set to **P**.
- ▶ Do not depress the brake pedal.

Unlocking

Position 0

Before you press the KEYLESS-GO start/stop button, the vehicle's on-board electronics have status **0** (as with SmartKey removed).

Position 1

- ▶ Press the KEYLESS-GO start/stop button once.

This supplies power for some electrical consumers, such as seat adjustment.



If you now press the KEYLESS-GO start/stop button

- once again, the ignition (position **2**) is switched on.
- twice, the power supply is again switched off.

Ignition (or position 2)

- ▶ Press the KEYLESS-GO start/stop button twice.

This supplies power for all electrical consumers. All the lamps (except low beam headlamp indicator lamp, high beam headlamp indicator lamp, and turn signal indicator lamps unless activated) in the instrument cluster come on. If a lamp in the instrument cluster fails to come on when the ignition is switched on, have it checked and replaced if necessary. If a lamp in the instrument cluster remains on after starting the engine or comes on while driving, refer to “Lamps in instrument cluster” (▷ page 374).



If you now press the KEYLESS-GO start/stop button once, the power supply is again switched off.



When you switch on the ignition, the indicator and warning lamps (except low beam headlamp indicator lamp, high beam headlamp indicator lamp, and turn signal indicator lamps unless activated) in the instrument cluster come on. The indicator and warning lamps (except low beam headlamp indicator lamp, high beam headlamp indicator lamp, and turn signal indicator lamps if activated) will go out when the engine is running. This indicates that the respective systems are operational.

For more information, see “SmartKey with KEYLESS-GO*” (▷ page 100).

For information on starting the engine using the KEYLESS-GO start/stop button, see “Starting with KEYLESS-GO*” (▷ page 49).

▼ Adjusting

Warning!



All seat, head restraint, steering wheel, and rear view mirror adjustments, as well as fastening of seat belts, must be done before the vehicle is put into motion.

Seats

Warning!



Do not adjust the driver's seat while driving. Adjusting the seat while driving could cause the driver to lose control of the vehicle.

Never ride in a moving vehicle with the seat back in an excessively reclined position as this can be dangerous. You could slide under the seat belt in a collision. If you slide under it, the belt would apply force at the abdomen or neck. That could cause serious or fatal injuries. The seat back and seat belts provide the best restraint when the wearer is in a nearly upright position and belts are properly positioned on the body.

Your seat must be adjusted so that you can correctly fasten your seat belt (▷ page 45).

Never place hands under the seat or near any moving parts while a seat is being adjusted.

Warning!



When leaving the vehicle, always remove the SmartKey or SmartKey with KEYLESS-GO* from the starter switch, take it with you, and lock the vehicle.

Even with the SmartKey or SmartKey with KEYLESS-GO* removed from the starter switch, or the SmartKey with KEYLESS-GO* removed from the vehicle, the power seats can be operated when the respective door is open. Therefore, do not leave children unattended in the vehicle, or with access to an unlocked vehicle. Unsupervised use of vehicle equipment may cause an accident and/or serious personal injury.

Warning!



According to accident statistics, children are safer when properly restrained in the rear seating positions than in the front seating position. Thus, we strongly recommend that children be placed in the rear seats whenever possible. Regardless of seating position, children 12 years old and under must be seated and properly secured in an appropriate infant, or toddler restraint, or booster seat recommended for the size and weight of the child. For additional information, see "Children in the vehicle" (▷ page 75).

A child's risk of serious or fatal injuries is significantly increased if the child restraints are not properly secured in the vehicle and/or the child is not properly secured in the child restraint.

Adjusting

Seat adjustment

The seat adjustment switches are located on the respective door.

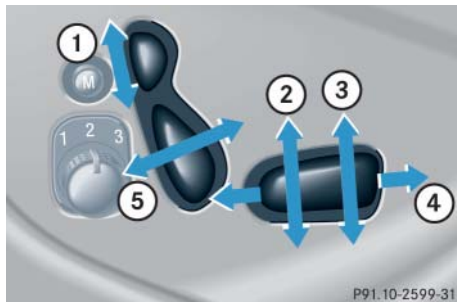

- ① Head restraint height
- ② Seat height
- ③ Seat cushion tilt
- ④ Seat fore and aft adjustment
- ⑤ Backrest tilt

- ▶ Switch on the ignition (▷ page 34).
- or
- ▶ Open the respective door.



The memory function (▷ page 124) lets you store the settings for the seat position together with the settings for the steering wheel and the exterior rear view mirrors.

Seat fore and aft adjustment

- ▶ Press switch forward or backward in direction of arrow ④.

Adjust seat to a comfortable seating position that still allows you to reach the accelerator / brake pedal safely. The position should be as far to the rear as possible, consistent with ability to properly operate controls.



When moving the seat, make sure there are no items in the footwell or behind the seats. Otherwise you could damage the seats.

Seat height

- ▶ Press switch up or down in direction of arrow ②.

Seat cushion tilt

- ▶ Press switch up or down in direction of arrow ③ until your upper legs are lightly supported.

Seat backrest tilt

- ▶ Press switch forward or backward in direction of arrow ⑤ until your arms are slightly angled when holding the steering wheel.

Head restraint height

- ▶ Press switch up or down in direction of arrow ①.



Adjust the head restraint in such a way that it is as close to the head as possible.

Warning!

For your protection, drive only with properly positioned head restraints.

Adjust head restraint so that the center of the head restraint supports the back of the head at eye level. This will reduce the potential for injury to the head and neck in the event of an accident or similar situation.

Do not drive the vehicle without the seat head restraints. Head restraints are intended to help reduce injuries during an accident.

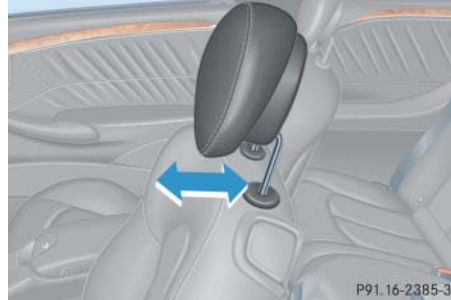
Head restraint adjusting

Manually adjust the head restraint.

- ▶ Push or pull the head restraint cushion to the desired position.



Adjust the head restraint in such a way that it is as close to the head as possible.

For more information, see “Seats” (▷ page 119).

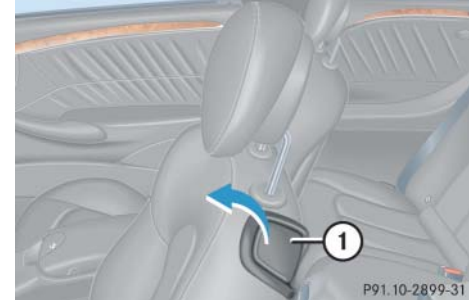
Folding front seat backrests forward

① Release lever

Folding backrests forward

- ▶ Pull release lever ① forward and fold the seat backrest forward.

The head restraint will automatically move down.

Folding backrests back

- ▶ Fold and press the backrest rearward until it engages in driving position.

The head restraint returns to its previous position.



Adjusting



In addition to the front seat backrests, the front seat cushions can also be shifted forward to permit easy access to the rear whenever the seat is located in the rear half of its adjustment range. Pivot backrest forward by pulling the release lever until the seat moves in a combined forward and upward movement.



When moving the seat, make sure there are no items in the footwell or behind the seats. Otherwise you could damage the seats.

Warning!



The seat belts provide protection only with the backrest locked in place. Therefore, the backrest must be locked in place with the vehicle in motion. Do not drive the vehicle when the backrest is not locked in place. If the warning message:

Lock front
passenger seat

or

Lock driver's
seat

is displayed in the multifunction display, then the respective backrest is not engaged in its lock. Carefully slow down, and drive with caution to an area which is in a safe distance from the roadway. Always provide sufficient room behind the backrest and fold the backrest all the way back until it locks in place.

The warning message is no longer displayed as soon as the backrest is locked in place. If both backrests are locked in place and the warning message is still displayed, have the system checked at an authorized Mercedes-Benz Center immediately.

When leaving the vehicle, always remove the SmartKey or SmartKey with KEYLESS-GO* from the starter switch, take it with you, and lock the vehicle.

The power seats can also be operated with the driver's or passenger door open. Do not leave children unattended in the vehicle or with access to an unlocked vehicle. Unsupervised use of vehicle equipment may cause an accident and/or serious personal injury.

Never place hands under seat or near any moving parts during a seat adjustment procedure.

For information on additional convenience features permitting easy entry and exit, see "Easy-entry/exit feature" (▷ page 42).

Steering wheel

Warning!



Do not adjust the steering wheel while driving. Adjusting the steering wheel while driving could cause the driver to lose control of the vehicle.

When leaving the vehicle, always remove the SmartKey or SmartKey with KEYLESS-GO* from the starter switch, take it with you, and lock the vehicle.

Even with the SmartKey or SmartKey with KEYLESS-GO* removed from the starter switch, or the SmartKey with KEYLESS-GO* removed from the vehicle, the steering wheel adjustment feature can be operated when the driver's door is open. Therefore, do not leave children unattended in the vehicle, or with access to an unlocked vehicle. Unsupervised use of vehicle equipment may cause an accident and/or serious personal injury.

Steering wheel adjustment

The stalk for steering wheel adjustment is located on the lower left of steering column.

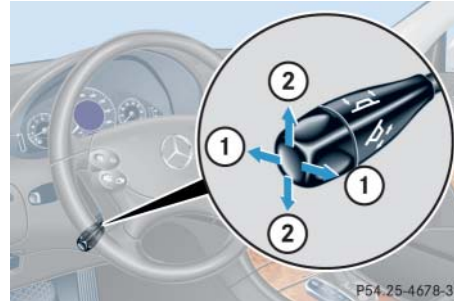

- ① Adjusting steering column, in or out
- ② Adjusting steering column, up or down

- ▶ Switch on the ignition (▷ page 34).
- or
- ▶ Open the driver's door.

Adjusting steering column in or out

- ▶ Move stalk forward or back in direction of arrow ① until a comfortable steering wheel position is reached with your arms slightly bent at the elbow.

Adjusting steering column up or down

- ▶ Move stalk up or down in direction of arrow ②.

Make sure your legs can move freely and all the displays (including malfunction and indicator lamps) on the instrument cluster are clearly visible.



The memory function (▷ page 124) lets you store settings for the steering wheel together with the settings for the exterior rear view mirrors and the seat position.

Adjusting

Easy-entry/exit feature

This feature allows for easier entry into and exit from the vehicle. When entering and exiting the vehicle, the steering wheel is in its uppermost position.

The easy-entry/exit feature can be activated or deactivated in the Convenience submenu of the control system (▷ page 160).

Warning!



You must make sure that no one can become trapped or injured by the moving steering wheel when the easy-entry / exit feature is activated.

To stop steering wheel movement, do one of the following:

- Move the steering column stalk (▷ page 41).
- Press the memory position switch (▷ page 124).

Do not leave children unattended in the vehicle, or with access to an unlocked vehicle. Children could open the driver's door and unintentionally activate the easy-entry/exit feature, which could result in an accident and/or serious personal injury.

With the easy-entry/exit feature activated, the steering wheel will return to its last set position when you:

- close the driver's door with the ignition switched on,
or
- insert the SmartKey into the starter switch or press the KEYLESS-GO* start/stop button (▷ page 35) once with the driver's door closed.



The last set steering wheel position is stored when

- the ignition is switched off.
- the position is stored in memory (▷ page 125).

With the easy-entry/exit feature activated, the steering wheel tilts upwards when you:

- remove the SmartKey from the starter switch,
or
- open the driver's door with the SmartKey in starter switch position **0** or **1** or the KEYLESS-GO* start/stop button (▷ page 35) in position **1**.



If the current position for the steering wheel is in the uppermost tilt position, the steering wheel will no longer be able to move upward when the easy-entry/exit feature is activated.

Repositioning of the steering wheel:

- will be halted briefly when you start the vehicle.
- will stop if you start the vehicle and set off immediately.

Warning!

Let the system complete the adjustment procedure before setting the vehicle in motion. All steering wheel adjustment must be completed before setting the vehicle in motion. Driving off with the steering wheel still adjusting could cause the driver to lose control of the vehicle.

Mirrors

Adjust the interior and exterior rear view mirrors before driving so that you have a good view of the road and traffic conditions.

Warning!

In case of an accident, liquid electrolyte may escape the mirror housing if the mirror glass breaks.

Electrolyte has an irritating effect. Do not allow the liquid to come into contact with eyes, skin, clothing, or respiratory system. In case it does, immediately flush affected area with water, and seek medical help if necessary.



Electrolyte drops coming into contact with the vehicle paint finish can only be completely removed while in their liquid state and by applying plenty of water.

Interior rear view mirror

- ▶ Manually adjust the interior rear view mirror.

For more information, see “Rear view mirrors” (▶ page 181).

Exterior rear view mirrors**Warning!**

Exercise care when using the passenger-side exterior rear view mirror. The mirror surface is convex (outwardly curved surface for a wider field of view). Objects in mirror are closer than they appear. Check your interior rear view mirror or glance over your shoulder before changing lanes.



Adjusting

- ▷▷ The buttons are located above the exterior lamp switch.

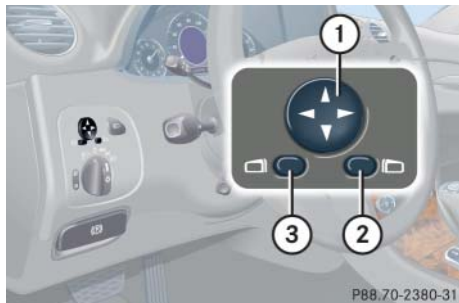

- ① Adjustment button
- ② Passenger-side exterior rear view mirror button
- ③ Driver's side exterior rear view mirror button

- ▶ Switch on the ignition (▷ page 34).
- ▶ Press button ③ for the driver's side exterior rear view mirror or button ② for the passenger-side exterior rear view mirror.
- ▶ Push adjustment button ① up, down, left, or right, according to the desired setting.



If an exterior rear view mirror was forcibly pushed forward (hit from the rear) or forcibly pushed rearward (hit from the front), reposition it by applying firm pressure until it snaps into place. The mirror housing is now properly positioned and you can adjust the mirror normally.



The memory function (▷ page 124) lets you store the setting for the exterior rear view mirrors together with the settings for the steering wheel and seat position.



At low ambient temperatures, the exterior rear view mirrors will be heated automatically.

For more information, see “Rear view mirrors” (▷ page 181).

▼ Driving

Warning!



Do not lay any objects in the driver's footwell. Be careful that floor mats or carpets in the driver's footwell have sufficient clearance for the pedals.

During sudden driving or braking maneuvers, the objects could get caught between the pedals. You could then no longer brake or accelerate.

Fastening the seat belts

Warning!



Always fasten your seat belt before driving off. Always make sure your passengers are properly restrained, even those sitting in the rear and pregnant women.

Failure to wear and properly fasten and position your seat belt greatly increases your risk of injuries and their likely severity in an accident. You and your passengers should always wear seat belts.

If you are ever in an accident, your injuries can be considerably more severe without your seat belt properly buckled. Without your seat belt buckled, you are much more likely to hit the interior of the vehicle or be ejected from it. You can be seriously injured or killed.

In the same crash, the possibility of injury or death is lessened if you are wearing your seat belt. The air bags can only provide the protection they were designed to afford if the occupants are using their seat belts (▷ page 62).

Warning!



According to accident statistics, children are safer when properly restrained in the rear seating positions than in the front seating position. Thus, we strongly recommend that children be placed in the rear seats. Regardless of seating position, children 12 years old and under must be seated and properly secured in an appropriate infant or toddler restraint, or booster seat recommended for the size and weight of the child. For additional information, see "Children in the vehicle" (▷ page 75).

A child's risk of serious or fatal injuries is significantly increased if the child restraints are not properly secured in the vehicle and/or the child is not properly secured in the child restraint.

Warning!



Never let more people ride in the vehicle than there are seat belts available. Be sure everyone riding in the vehicle is correctly restrained with a separate seat belt. Never use a seat belt for more than one person at a time.

Warning!



Never ride in a moving vehicle with the seat backrest in an excessively reclined position as this can be dangerous. You could slide under the seat belt in a collision. If you slide under it, the belt would apply force at the abdomen or neck. This could cause serious or even fatal injuries. The seat backrest and seat belt provide the best restraint when the wearer is in a nearly upright position and the belt is properly positioned on the body.

Warning!



Read and observe the additional warning notices printed in the “Safety and Security” section (> page 66).

The seat belt presenter for driver and passenger makes it easier to put on the seat belt.

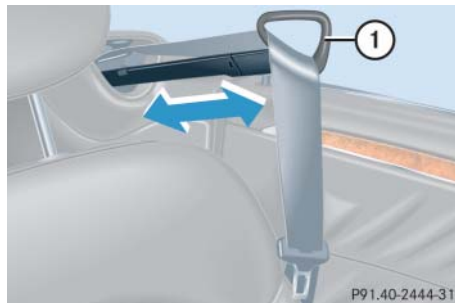

① Seat belt presenter

The seat belt presenter slides out when the corresponding door is closed and the ignition is switched on (> page 34).

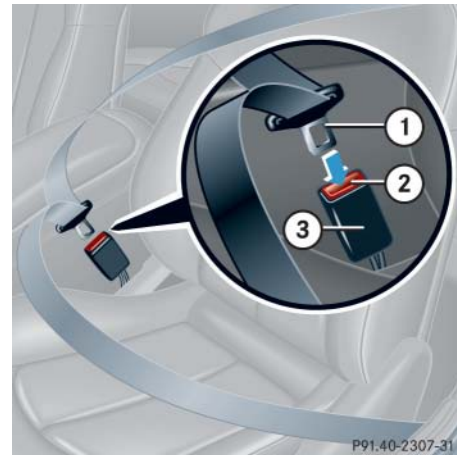

- ① Latch plate
- ② Release button
- ③ Buckle

▶ With a smooth motion, pull the belt out of the seat belt presenter.

- ▶ Place the shoulder portion of the belt across the top of your shoulder and the lap portion across your hips.
 - ▶ Push latch plate ① into buckle ③ until it clicks.
 - ▶ If necessary, tighten the lap portion to a snug fit by pulling shoulder portion up.
- Position the lap belt as low as possible on your hips (over hip joint) and not across the abdomen.
 - Place the seat backrest in a nearly upright position.
 - Never use a seat belt for more than one person at a time.
 - Do not fasten a seat belt around a person and another object at the same time. When using a seat belt to secure infant or toddler restraints or children in booster seats, always follow the child seat manufacturer's instructions.
 - Check your seat belt periodically during travel to make sure that it is properly positioned.
 - Make sure that the seat belt is always fitted snugly. Take special care of this when wearing loose clothing.

Proper use of seat belts

- Do not twist the belt when fastening.
- Adjust seat belt so that the shoulder portion is located as close as possible to the middle of the shoulder (it should not touch the neck). Never pass the shoulder portion of the belt under your arm.

Warning!



Do not pass belts over sharp edges. They could tear.

Do not allow the belt to get caught in the door or in the seat adjustment mechanism. This could damage the belt.

Never attempt to make modifications to seat belts. This could impair the effectiveness of the belts.

Do not bleach or dye seat belts as this may severely weaken them. In a crash they may not be able to provide adequate protection.

Damaged seat belts or belts that were highly stressed in an accident must be replaced. Contact an authorized Mercedes-Benz Center.

Driving

The seat belt presenter slides back:

- right after you pushed the latch plate ① into buckle ③ and heard it click.
- after approximately 60 seconds if you did not push latch plate ① into buckle ③.
- if your door is opened.
- if you turn the SmartKey in the starter switch to position **0**.
- if you release a front seat backrest and fold it forward.

Warning!



The seat belt presenter must be retracted while the vehicle is in motion. Only when the seat belt presenter is retracted can the seat belt be properly positioned on the body and protect the occupant as intended.

Starting the engine

Warning!



Inhalation of exhaust gas is hazardous to your health. All exhaust gas contains carbon monoxide, and inhaling it can cause unconsciousness and possible death.

Do not run the engine in confined areas (such as a garage) which are not properly ventilated. If you think that exhaust gas fumes are entering the vehicle while driving, have the cause determined and corrected immediately. If you must drive under these conditions, drive with at least one window fully open.

Automatic transmission

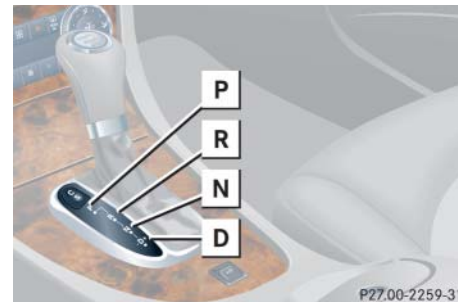

Gearshift pattern for automatic transmission

- P** Park position with gear selector lever lock
- R** Reverse gear
- N** Neutral
- D** Drive position

For more information, see “Automatic transmission” (▷ page 166).

Starting with the SmartKey

- ▶ Make sure the gear selector lever is set to **P**.
- ▶ Do not depress accelerator.
- ▶ Turn the SmartKey in the starter switch to position **3** (▷ page 34) and release it again immediately (“touch-start”).

The engine then starts automatically.

For information on turning off the engine with the SmartKey, see (▷ page 58).

Starting with KEYLESS-GO*

Warning!



As long as the SmartKey with KEYLESS-GO is in your vehicle, the vehicle can be started. Therefore, never leave children unattended in the vehicle, as they could otherwise accidentally start the engine.

When leaving the vehicle, always take the SmartKey with KEYLESS-GO with you and lock the vehicle. Do not leave children unattended in the vehicle, or with access to an unlocked vehicle.

You can start your vehicle without the SmartKey in the starter switch using the KEYLESS-GO start/stop button on the gear selector lever.

The SmartKey with KEYLESS-GO must be located in the vehicle.

- ▶ Make sure the gear selector lever is set to **P**.
- ▶ Do not depress accelerator.

- ▶ Depress the brake pedal during the starting procedure.

The gear selector lever lock is released.

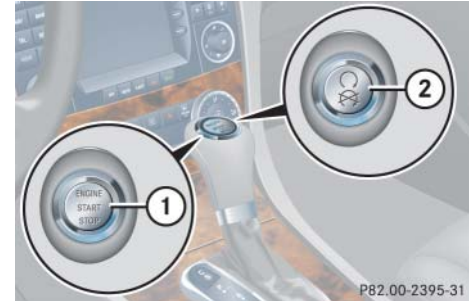

KEYLESS-GO start/stop button

- ① USA only
- ② Canada only

- ▶ Press KEYLESS-GO start/stop button once.

The engine starts if the SmartKey with KEYLESS-GO is in the vehicle.

For information on turning off the engine with KEYLESS-GO, see “Turning off the engine with KEYLESS-GO*” (▷ page 59).

Driving

Starting difficulties

If the engine does not start as described, carry out the following steps:

- ▶ If you are starting the engine with the SmartKey, turn SmartKey in starter switch to position **0** and repeat starting procedure.
- ▶ If you are starting the engine with KEYLESS-GO*: Close any doors that may be open to allow for better detection of the SmartKey with KEYLESS-GO*.
Or:
Start the engine with the SmartKey as radio signals from another source may be interfering with the SmartKey with KEYLESS-GO*.
- ▶ Repeat the starting procedure (▷ page 48).
Remember that extended starting attempts can drain the battery.
- ▶ Get a jump start (▷ page 456).

If the engine does not start after several starting attempts, there could be a malfunction in the engine electronics or in the fuel supply system.

- ▶ Notify an authorized Mercedes-Benz Center.

Parking brake

Warning!



When leaving the vehicle, always remove the SmartKey or SmartKey with KEYLESS-GO* from the starter switch, take it with you, and lock the vehicle. Do not leave children unattended in the vehicle, or with access to an unlocked vehicle. Children could release the parking brake, which could result in an accident and/or serious personal injury.

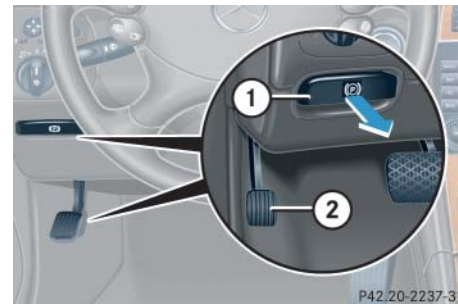

P42.20-2237-31

- ① Release handle
- ② Parking brake pedal

- ▶ Release the parking brake by pulling on release handle ①.

The indicator lamp **BRAKE** (USA only) or  (Canada only) in the clock goes out.

Driving

- ▶ Depress the brake pedal.
- ▶ Move gear selector lever to position **D** or **R**.



Wait for the gear selection process to complete before setting the vehicle in motion.

- ▶ Release the brake pedal.
- ▶ Carefully depress the accelerator pedal.

Once the vehicle is in motion, the automatic central locking system engages and the locking knobs drop down.



You can open a locked door from the inside. Open door only when conditions are safe to do so.

You can deactivate the automatic locking using the control system (▷ page 159).



Simultaneously depressing the accelerator pedal and applying the brake reduces engine performance and causes premature brake and drivetrain wear.



If you hear a warning signal and the message *Release parking brake* appears in the multifunction display when driving off, you have forgotten to release the parking brake.

Release the parking brake.

After a cold start, the automatic transmission shifts at a higher engine revolution. This allows the catalytic converter to reach its operating temperature earlier.

Warning!



On slippery road surfaces, never downshift in order to obtain braking action. This could result in drive wheel slip and reduced vehicle control. Your vehicle's ABS will not prevent this type of loss of control.



Place the gear selector lever in position **R** or **P** only when the vehicle is stopped in order to avoid damaging the transmission.



Do not run cold engine at high engine speeds. Running a cold engine at high engine speeds may shorten the service life of the engine.

Warning!



It is dangerous to shift the gear selector lever out of **P** or **N** if the engine speed is higher than idle speed. If your foot is not firmly on the brake pedal, the vehicle could accelerate quickly forward or in reverse. You could lose control of the vehicle and hit someone or something. Only shift into gear when the engine is idling normally and when your right foot is firmly on the brake pedal.

For more information on driving, see “Driving instructions” (▷ page 307).

Switching on headlamps

For more information on headlamps, see “Lighting” (▷ page 127).

Low beam headlamps

The exterior lamp switch is located on the dashboard to the left of the steering wheel.



Exterior lamp switch

- ① Off
- ② Low beam headlamps on

- ▶ Turn exterior lamp switch to position .

The low beam headlamp indicator lamp  in the instrument cluster comes on (▷ page 24).

High beam

The combination switch is located on the left of the steering column.

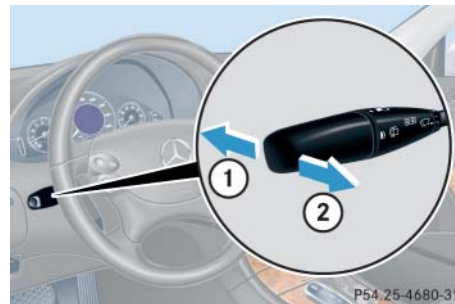

Combination switch

- ① High beam
- ② High beam flasher

- ▶ Push combination switch in direction of arrow ①.

The high beam headlamp indicator lamp  in the instrument cluster comes on (▷ page 24).

Turn signals

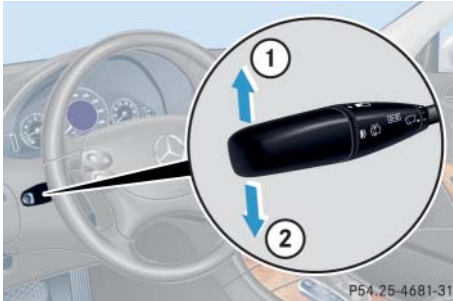

The combination switch is located on the left of the steering column.



Combination switch

- ① Turn signals, right
- ② Turn signals, left

- ▶ Press combination switch in direction of arrow ① or ②.

The corresponding turn signal indicator lamp  or  in the instrument cluster flashes (▷ page 24).

The combination switch resets automatically after major steering wheel movements.



To signal minor directional changes such as changing lanes, press combination switch only to the point of resistance and release. The corresponding turn signals will flash three times.

Windshield wipers

The combination switch is located on the left of the steering column.

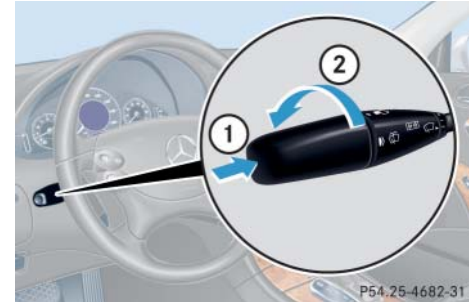

Combination switch

- ① Single wipe
Wiping with windshield washer fluid
 - ② Switching on windshield wipers
- ▶ Switch on the ignition (▷ page 34).



Do not operate the windshield wipers when the windshield is dry. Dust that accumulates on a windshield might scratch the glass and/or damage the wiper blades when wiping occurs on a dry windshield. If it is necessary to operate the windshield wipers in dry weather conditions, always operate the windshield wipers with windshield washer fluid (▷ page 55).

Switching on windshield wipers

- ▶ Turn the combination switch to the desired position depending on the intensity of the rain.
 - O** Windshield wipers off
 - I** Intermittent wiping
 - II** Normal wiper speed
 - III** Fast wiper speed

Intermittent wiping



Do not leave windshield wipers in intermittent setting when the vehicle is taken to an automatic car wash or during windshield cleaning. Windshield wipers will operate in the presence of water sprayed on the windshield, and windshield wipers may be damaged as a result.

Intermittent wiping interval is dependent on wetness of windshield.

- ▶ Turn the combination switch to position **I**.

After the initial wipe, pauses between wipes are automatically controlled by the rain sensor.



Intermittent wiping is interrupted when the vehicle is at a standstill and a door is opened. This protects persons getting into or out of the vehicle from being sprayed.

Intermittent wiping will be continued when

- all doors are closed
- and
- the gear selector lever is in position **D** or **R**
- or
- the wiper setting is changed using the combination switch

Single wipe

- ▶ Press the combination switch briefly in direction of arrow ① to the resistance point.

The windshield wipers wipe one time without washer fluid.

Wiping with windshield washer fluid

- ▶ Press the combination switch in direction of arrow ① past the resistance point.

The windshield wipers operate with washer fluid.



To prevent smears on the windshield, wipe with windshield washer fluid every now and then even when it is raining.

For information on filling up the washer reservoir, see “Windshield washer system and headlamp cleaning system*” (▷ page 329).



If anything blocks the windshield wipers (leaves, snow, etc.), switch them off immediately.

- For safety reasons, stop the vehicle in a safe location and,
 - remove SmartKey from starter switch

or

- turn off the engine by pressing the KEYLESS-GO* start/stop button and open the driver’s door (with the driver’s door open, starter switch is in position **0**, same as with SmartKey removed from starter switch)

before attempting to remove any blockage.

- Remove blockage.
- Turn the windshield wipers on again.

If windshield wipers fail to function at all in combination switch position **I**,

- set the combination switch to the next higher wiper speed
- have the windshield wipers checked at the nearest authorized Mercedes-Benz Center.

Problems while driving

The engine runs erratically and misfires

- An ignition cable may be damaged.
- The engine electronics may not be operating properly.
- Unburned gasoline may have entered the catalytic converter and damaged it.
- ▶ Give very little gas.
- ▶ Have the problem repaired by an authorized Mercedes-Benz Center as soon as possible.

The coolant temperature is above 248°F (120°C)

The coolant is too hot and is no longer cooling the engine.

- ▶ Stop the vehicle in a safe location as soon as possible and turn off the engine. Allow engine and coolant to cool.
- ▶ Check the coolant level and add coolant if necessary (▷ page 327).

In case of accident

If the vehicle is leaking gasoline:

- ▶ Do not start the engine under any circumstances.
- ▶ Notify local fire and/or police authorities.

If the extent of the damage cannot be determined:

- ▶ Notify an authorized Mercedes-Benz Center.

If no damage can be determined on the

- major assemblies
- fuel system
- engine mount:
- ▶ Start the engine in the usual manner.

▼ Parking and locking

You have now completed your first drive. You have properly stopped and parked your vehicle. End your drive as follows:

Warning!



With the engine not running, there is no power assistance for the brake and steering systems. In this case, it is important to keep in mind that a considerably higher degree of effort is necessary to brake and steer the vehicle.

Warning!



Do not park this vehicle in areas where combustible materials such as grass, hay or leaves can come into contact with the hot exhaust system, as these materials could be ignited and cause a vehicle fire.

Warning!



To reduce the risk of personal injury as a result of inadvertent vehicle movement, before turning off the engine and leaving the vehicle always:

- Keep right foot on brake pedal.
- Firmly depress parking brake pedal.
- Move the gear selector lever to position **P**.
- Slowly release brake pedal.
- When parked on an incline, turn front wheel towards the road curb.
- Turn the SmartKey to starter switch position **0** and remove, or press start / stop button (vehicles with KEYLESS-GO*).
- Take the SmartKey or the SmartKey with KEYLESS-GO* and lock vehicle when leaving.

Parking brake

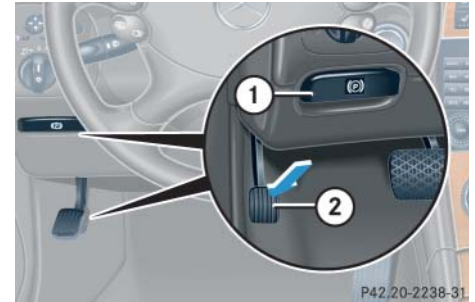

- ① Release handle
- ② Parking brake pedal

- ▶ Step firmly on parking brake pedal ②.

When the engine is running, the warning lamp **BRAKE** (USA only) or **(P)** (Canada only) in the instrument cluster will be illuminated.

Warning!



When leaving the vehicle, always remove the SmartKey or SmartKey with KEYLESS-GO* from the starter switch, take it with you, and lock the vehicle. Do not leave children unattended in the vehicle, or with access to an unlocked vehicle. Children could release the parking brake and/or move the gear selector lever from position **P**, either of which could result in an accident and/or serious personal injury.

Warning!



Getting out of your vehicle with the gear selector lever not fully engaged in position **P** is dangerous. Also, when parked on an incline, position **P** alone may not prevent your vehicle from moving, possibly hitting people or objects.

Always set the parking brake in addition to shifting to position **P** (▷ page 168).

When parked on an incline, turn front wheels towards the road curb.

Switching off headlamps

- ▶ Turn the exterior lamp switch to **0** (▷ page 52).

For more information, see “Lighting” (▷ page 127).

Turning off the engine

- ▶ Place the gear selector lever in position **P**.



Always set the parking brake in addition to shifting to position **P**.

On slopes, turn the front wheels towards the curb.

Turning off the engine with the SmartKey

- ▶ Turn the SmartKey in the starter switch (▷ page 34) to position **0** and remove it. The immobilizer is activated.



The SmartKey can only be removed from the starter switch with the gear selector lever in position **P**.

Turning off the engine with KEYLESS-GO*

- ▶ Press the KEYLESS-GO start/stop button to shut off the engine.

With the driver's door closed, the starter switch is now in position **1**. With the driver's door opened, the starter switch is set to position **0**, same as SmartKey removed from starter switch (▷ page 34).



If you hear a warning signal you have either tried to turn off the engine while the gear selector lever is not in **P**.

Place the gear selector lever in **P**.

Releasing seat belts

- ▶ Press the seat belt release button (▷ page 46).

Allow the retractor to completely rewind the seat belt by guiding the latch plate.



Make sure the seat belt retracts fully so that the seat belt and/or latch plate cannot get caught or pinched in the door or in the seat mechanism. This can damage the seat belt and impair the effectiveness of the seat belt, and/or cause damage to the door and/or door trim panel. Such damage is not covered by the Mercedes-Benz Limit Warranty.

Damaged seat belts must be replaced. Contact an authorized Mercedes-Benz Center.

Locking

Warning!



To prevent possible personal injury, always keep hands and fingers away from the door openings when closing the doors. Be especially careful when small children are around.

Before closing doors, make sure there is no possibility of someone getting caught in a door during closing.

Warning!



When leaving the vehicle, always remove the SmartKey or SmartKey with KEYLESS-GO* from the starter switch, take it with you, and lock the vehicle. Do not leave children unattended in the vehicle, or with access to an unlocked vehicle. Unsupervised use of vehicle equipment may cause an accident and/or serious personal injury.

Parking and locking



Opening a door causes the windows on that side of the car to open slightly. They will return to the up position when the door is closed.



A warning sounds and the message *Turn off lamps* appears in the multi-function display if the vehicle's exterior lamps are not switched off

- with the SmartKey removed from the starter switch and the driver's door open
- with the engine turned off using the KEYLESS-GO* start/stop button and the driver's door open (same as SmartKey removed from starter switch)

Switch off the exterior lamps.

- ▶ Exit the vehicle, take the SmartKey or the SmartKey with KEYLESS-GO* with you, and close all doors and the trunk lid.

Locking with the SmartKey

- ▶ Press lock button  on the SmartKey (▷ page 32).

With the trunk and both doors closed, all turn signal lamps flash three times. The locking knobs in the doors move down. The anti-theft alarm system is armed.

For more information, see “SmartKey” (▷ page 96).

Locking with KEYLESS-GO*

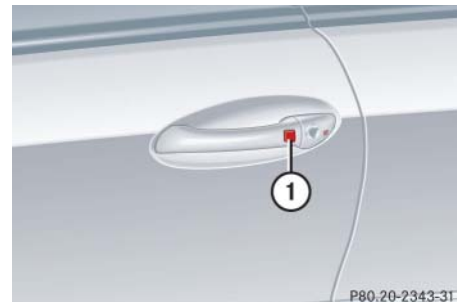

① Lock button

- ▶ Press lock button ① on an outside door handle or on the trunk lid (▷ page 106).

With the trunk and both doors closed, all turn signal lamps flash three times. The locking knobs in the doors move down. The anti-theft alarm system is armed.

For more information, see “SmartKey with KEYLESS-GO*” (▷ page 100).

Safety and Security

Occupant safety

Panic alarm

Driving safety systems

Anti-theft systems



Occupant safety

In this section you will learn the most important facts about the restraint system components of the vehicle.

- Seat belts (▷ page 69)
- Child restraints (▷ page 75)
- Lower anchors and tethers for children (LATCH) (▷ page 83)

Supplemental Restraint System (SRS) with

- Air bags (▷ page 63)
- Air bag control unit (with crash sensors)
- Emergency tensioning device (ETD) for seat belts (▷ page 72)

Air bag system components with

- Front passenger front air bag off indicator lamp (▷ page 81)
- Front passenger seat with Occupant Classification System (OCS) (▷ page 78)

As independent systems, their protective functions work in conjunction with each other.



For information on infants and children traveling with you in the vehicle and restraint systems for infants and children, see “Children in the vehicle” (▷ page 75).

The SRS system conducts a self-test when the ignition is switched on and in regular intervals while the engine is running. This facilitates early detection of malfunctions. The **SRS** indicator lamp in the instrument cluster comes on when the ignition is switched on and goes out no later than a few seconds after the engine has been started.

The SRS components are in operational readiness if the **SRS** indicator lamp is not lit when the engine is running.

A malfunction in the system has been detected if the **SRS** indicator lamp:

- fails to go out after approximately four seconds after the engine was started
- does not come on at all
- comes on after the engine was started or while driving

Air bags

Warning!



In the event that the **SRS** indicator lamp comes on during driving or does not come on at all, the SRS self-check has detected a malfunction. For your safety, we strongly recommend that you visit an authorized Mercedes-Benz Center immediately to have the system checked; otherwise the SRS may not deploy when needed in an accident, which could result in serious or fatal injury, or it might deploy unexpectedly and unnecessarily which could also result in injury.

In addition, improper repair work on the SRS creates a risk of rendering the SRS inoperative or causing unintended air bag deployment. Work on the SRS must therefore only be performed by qualified technicians. Contact an authorized Mercedes-Benz Center.

If it is necessary to modify an air bag system to accommodate a person with disabilities, contact your local authorized Mercedes-Benz Center or call our Customer Assistance Center at 1-800-FOR-MERCEdes (1-800-367-6372) for details.

Warning!



Air bags are designed to reduce the potential of injury and fatality in certain frontal impacts (front air bags) or side impacts (head-thorax air bags and rear side impact air bags*). However, no system available today can totally eliminate injuries and fatalities.

The deployment of the air bags temporarily releases a small amount of dust from the air bags. This dust, however, is neither injurious to your health, nor does it indicate a fire in the vehicle. The dust might cause some temporary breathing difficulty for people with asthma or other breathing trouble. To avoid this, you may wish to get out of the vehicle as soon as it is safe to do so. If you have any breathing difficulty but cannot get out of the vehicle after the air bag inflates, then get fresh air by opening a window or door.

Occupant safety

Warning!



To reduce the risk of injury when the front air bags inflate, it is very important for the driver and front passenger to always be in a properly seated position and to wear their respective seat belts.

For maximum protection in the event of a collision always be in normal seated position with your back against the backrest. Fasten your seat belt and make sure that it is properly positioned on your body.

Since the air bag inflates with considerable speed and force, a proper seating and hands on steering wheel position will help to keep you at a safe distance from the air bag. Occupants who are unbelted, out of position or too close to the air bag can be seriously injured or killed by an air bag as it inflates with great force in the blink of an eye:

- Sit properly belted in a nearly upright position with your back against the seat backrest.

- Adjust the driver's seat as far as possible rearward, still permitting proper operation of vehicle controls. The distance from the center of the driver's breastbone to the center of the air bag cover on the steering wheel must be at least ten inches (25 cm) or more. You should be able to accomplish this by a combination of adjustments to the seat and steering wheel. If you have any problems, please see an authorized Mercedes-Benz Center.
- Do not lean your head or chest close to the steering wheel or dashboard.
- Keep hands on the outside of steering wheel rim. Placing hands and arms inside the rim can increase the risk and potential severity of hand/arm injury when driver's front air bag inflates.
- Adjust the front passenger seat as far as possible rearward from the dashboard when the seat is occupied.

- Occupants, especially children, should never place their bodies or lean their heads in the area of the door or the rear side trim panel where the head-thorax air bag and/or the rear side impact air bag* inflates. This could result in serious injuries or death should the air bag be triggered. Always sit nearly upright, properly use the seat belts and use an appropriately sized infant or toddler restraint or booster seat recommended for the size and weight of the child.

Failure to follow these instructions can result in severe injuries to you or other occupants.

If you sell your vehicle, it is important that you make the buyer aware of this safety information. Be sure to give the buyer this Operator's Manual.

Warning!

Accident research shows that the safest place for children in an automobile is in the rear seat.

It should be noted that with respect to both head-thorax air bags and rear side impact air bags* there is a possibility for a head-thorax or rear side impact air bag* related injury if occupants, especially children, are not properly seated or restrained when next to a head-thorax air bag or a rear side impact air bag* which needs to deploy rapidly in a side impact in order to do its job.

To help avoid the possibility of injury, please follow these guidelines:

- (1) Occupants, especially children, should never place their bodies or lean their heads in the area of the door or the rear side trim panel where the head-thorax air bag and/or the rear side impact air bag* inflates.

This could result in serious injuries or death should the head-thorax air bag and/or the rear side impact air bag* be deployed.

- (2) Always sit nearly upright, properly use the seat belts and for children 12 years old and under, use an appropriately sized infant or toddler restraint or booster seat recommended for the size and weight of the child.

- (3) Always wear seat belts properly.

If you believe that, even with the use of these guidelines, it would be safer for your rear seat occupants to have the rear mounted side impact air bags* deactivated, then deactivation can be accomplished upon your written request to do so at an authorized Mercedes-Benz Center at an additional cost.

Please contact your local authorized Mercedes-Benz Center or call our Customer Assistance Center at 1-800-FOR-MERCEdes (1-800-367-6372) for details.



Air bags are designed to deploy only in certain frontal impacts (front air bags), and in side impacts (head-thorax air bags and rear side impact air bags*) which exceed preset thresholds. Only during these events will they provide their supplemental protection.

The driver and passengers should always wear their seat belts. Otherwise it is not possible for the air bags to provide their supplemental protection.

In case of other types of impacts and impacts below air bag deployment thresholds, air bags will not deploy. The driver and passenger will then be protected to the extent possible by a properly fastened seat belt. A properly fastened seat belt is also needed to provide the best possible protection in a rollover.

Occupant safety

We caution you not to rely on the presence of the air bags in order to avoid wearing your seat belt.

It is important to your safety and that of your passengers that you replace deployed air bags and repair any malfunctioning air bags to make sure that the vehicle will continue to provide supplemental crash protection for occupants.

Safety guidelines for the seat belt, emergency tensioning device and air bag

Warning!



- Damaged seat belts or belts that were highly stressed in an accident must be replaced and their anchoring points must also be checked. Only use belts installed or supplied by an authorized Mercedes-Benz Center.

- Air bags and emergency tensioning devices (ETDs) are designed to function on a one-time-only basis. An air bag or ETD that is deployed must be replaced.
- Do not pass belts over sharp edges. They could tear.
- Do not make any modification that could change the effectiveness of the belts.
- No modifications of any kind may be made to any components or wiring of the SRS. This includes changing or removing any component or part of the SRS, the installation of additional trim material, seat covers, badges, etc. over the steering wheel hub, front passenger front air bag cover, outboard sides of the front seat backrests, door frame trims, or rear side trim panels, and installation of additional electrical/electronic equipment on or near SRS components and wiring. Keep area between air bags and occupants free from objects (e.g. packages, purses, umbrellas, etc.).

- Do not bleach or dye seat belts as this may severely weaken them. In a crash they may not be able to provide adequate protection.
- Air bag system components will be hot after an air bag has inflated. Do not touch.
- Never place your feet on the instrument panel, dashboard, or on the seat. Always keep both feet on the floor in front of the seat.
- In addition, improper repair work on the SRS creates a risk of rendering the SRS inoperative or causing unintended air bag deployment. Work on the SRS must therefore only be performed by qualified technicians. Contact an authorized Mercedes-Benz Center.
- For your protection and the protection of others, when scrapping the air bag unit or emergency tensioning device, our safety instructions must be followed. These instructions are available from your authorized Mercedes-Benz Center.

- Given the considerable deployment speed, required inflation volume, and the textile structure of the air bags, there is the possibility of abrasions or other more significant injuries resulting from air bag deployment.

Warning!



Only use seat covers which have been tested and approved by Mercedes-Benz for your vehicle model. Using other seat covers may interfere with or prevent the deployment of the head-thorax air bags. Contact your authorized Mercedes-Benz Center for availability.

When you sell your vehicle, we strongly urge you to give notice to the subsequent owner that it is equipped with an SRS by alerting them to the applicable section in the Operator's Manual.

Front air bags

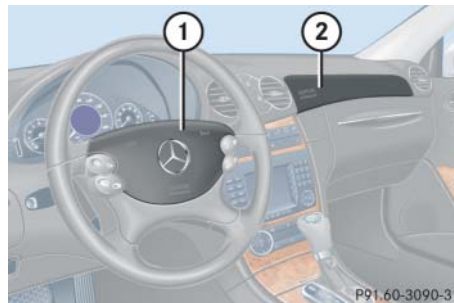

- ① Driver air bag
- ② Passenger air bag

Driver and front passenger front air bags are deployed:

- in the event of certain frontal impacts
- if impact exceeds a preset deployment threshold
- independently of the head-thorax air bags and/or rear side impact air bags*



The front air bags in this vehicle have been designed to inflate in two stages. This allows the air bag to have different rates of inflation that are based on the rate of relevant vehicle deceleration as assessed by the air bag control unit.

On the front passenger side, the front air bag deployment is additionally influenced by the passenger's weight category as identified by the Occupant Classification System (OCS) (> page 78).

The lighter the front passenger side occupant, the higher the vehicle deceleration rate required for the second stage inflation of the air bag.

The air bags will not deploy in impacts which do not exceed the system's deployment thresholds. You will then be protected by the fastened seat belts.

Occupant safety

The front passenger front air bag will only be deployed if:

- the system, based on OCS weight sensor readings, senses that the front passenger seat is occupied
- the  indicator lamp in the center console is not lit (▷ page 81)
- the impact exceeds a preset deployment threshold

Head-thorax air bags

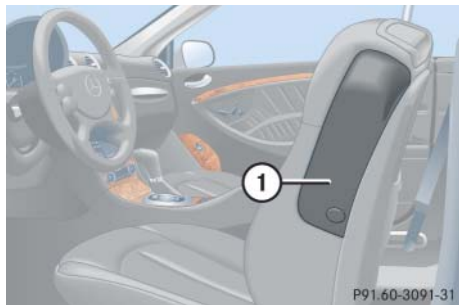

① Head-thorax air bag

The head-thorax air bags ① in the drivers and front passenger seat are deployed:

- on the impacted side of the vehicle
- in impacts exceeding a preset deployment threshold
- independently of the front air bags

The head-thorax air bags ① are not deployed in impacts which do not exceed the system's deployment threshold.

Warning!



Only use seat covers which have been tested and approved by Mercedes-Benz for your vehicle model. Using other seat covers may interfere with or prevent the deployment of the head-thorax air bags. Contact your authorized Mercedes-Benz Center for availability.

Rear side impact air bags*

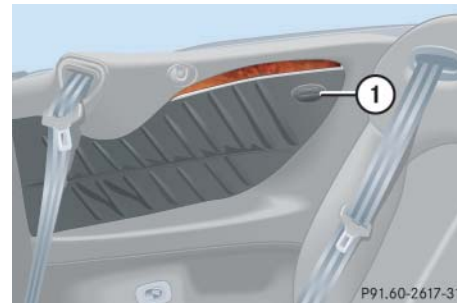

① Rear side impact air bag*

The rear side impact air bags* ① are deployed:

- on the impacted side of the vehicle
- in impacts exceeding a preset deployment threshold
- independently of the front air bags

The rear side impact air bags* ① are not deployed in impacts which do not exceed the system's deployment threshold.

Seat belts

The use of seat belts and infant and child restraint systems is required by law in all 50 states, the District of Columbia, the U.S. territories and all Canadian provinces.

Even where this is not the case, all vehicle occupants should have their seat belts fastened whenever the vehicle is in motion.

For more information, see “Fastening the seat belts” (▷ page 45).



For information on infants and children traveling with you in the vehicle and restraint systems for infants and children, see “Children in the vehicle” (▷ page 75).

Warning!



Always fasten your seat belt before driving off. Always make sure all of your passengers are properly restrained, even those sitting in the rear and pregnant women.

Failure to wear and properly fasten and position your seat belt greatly increases your risk of injuries and their likely severity in an accident. You and your passengers should always wear seat belts.

If you are ever in an accident, your injuries can be considerably more severe without your seat belt properly buckled. Without your seat belt buckled, you are much more likely to hit the interior of the vehicle or be ejected from it. You can be seriously injured or killed.

In the same crash, the possibility of injury or death is lessened if you are properly wearing your seat belt. Air bags can only protect as they are designed if the occupants are properly wearing their seat belts.

Warning!



Never ride in a moving vehicle with the seat backrest in an excessively reclined position as this can be dangerous. You could slide under the seat belt in a collision. If you slide under it, the belt would apply force at the abdomen or neck. That could cause serious or even fatal injuries. The seat backrest and seat belt provide the best restraint when the wearer is in a nearly upright position and the belt is properly positioned on the body.

Warning!



Never let more people ride in the vehicle than there are seat belts available. Make sure everyone riding in the vehicle is correctly restrained with a separate seat belt. Never use a seat belt for more than one person at a time.

Occupant safety

Warning!



Damaged seat belts or belts that were highly stressed in an accident must be replaced and their anchoring points must also be checked.

Only use seat belts which have been approved by Mercedes-Benz.

Do not make any modifications to the seat belts. This can lead to unintended activation of the ETDs or to failure.

Do not bleach or dye seat belts as this may severely weaken them. In a crash they may not be able to provide adequate protection.

Have all work carried out only by qualified technicians. Contact an authorized Mercedes-Benz Center.

Warning!



USE SEAT BELTS PROPERLY

- Seat belts can only work when used properly. Never wear seat belts in any other way than as described in this section, as that could result in serious injuries in case of an accident.
- Each occupant should wear their seat belt at all times, because seat belts help reduce the likelihood of and potential severity of injuries in accidents, including rollovers. The integrated restraint system includes SRS (driver air bag, passenger front air bag, head-thorax air bags and rear side impact air bags*), ETD (seat belt emergency tensioning device), and front seat knee bolsters. The system is designed to enhance the protection offered to properly belted occupants in certain frontal (front air bags and ETD) and side (head-thorax air bags and rear side impact air bags* and ETD) impacts which exceed preset deployment thresholds.



- Never wear the shoulder belt under your arm, against your neck or off your shoulder. In a frontal crash, your body would move too far forward. That would increase the chance of head and neck injuries. The belt would also apply too much force to the ribs or abdomen, which could severely injure internal organs such as your liver or spleen.
- Never wear belts over rigid or breakable objects in or on your clothing, such as eyeglasses, pens, keys etc., as these might cause injuries.
- Position the lap belt as low as possible on your hips and not across the abdomen. If the belt is positioned across your abdomen, it could cause serious injuries in a crash.
- Never use a seat belt for more than one person at a time. Do not fasten a seat belt around a person and another person or other objects.

- Belts should not be worn twisted. In a crash, you wouldn't have the full width of the belt to distribute impact forces. The twisted belt against your body could cause injuries.
- Pregnant women should also use a lap-shoulder belt. The lap belt portion should be positioned as low as possible on the hips to avoid any possible pressure on the abdomen.
- Never place your feet on the instrument panel, dashboard, or on the seat. Always keep both feet on the floor in front of the seat.
- When using a seat belt to secure infant or toddler restraints or children in booster seats, always follow the child seat manufacturer's instructions.



Enhanced seat belt reminder system

When the engine is started the seat belt telltale  illuminates for a maximum of six seconds and a warning chime sounds to remind you and your passengers to fasten your seat belts.

If after these six seconds, the driver's or the front passenger's seat belt (with the front passenger seat occupied) are not fastened with all doors closed,

- and the vehicle speed does not exceed 15 mph (25 km/h), the seat belt telltale  remains illuminated for as long as either the driver's or front passenger's seat belt is not fastened.
- and the vehicle speed exceeds 15 mph (25 km/h), the seat belt telltale  starts flashing and a warning chime sounds with increasing intensity until both the driver's and front passenger's seat belt are fastened, or for a maximum of 60 seconds from the time the

vehicle speed exceeded 15 mph (25 km/h) if either the driver's or front passenger's seat belt remains unfastened.

If the driver's or front passenger's seat belt remains unfastened after 60 seconds, the seat belt telltale  stops flashing and the warning chime stops sounding. The seat belt telltale  then continues to be illuminated for as long as either the driver's or front passenger's seat belt are not fastened.

The seat belt telltale  will only go out if both the driver and front passenger's seat belt (with the front passenger seat occupied) are fastened, or the vehicle is standing still and a front door is opened.

For more information on the seat belt telltale , see "Practical hints" (▷ page 379).

Occupant safety

Emergency tensioning device (ETD), seat belt force limiter

The seat belts are equipped with emergency tensioning devices and belt force limiters.

The ETD is designed to activate in the following cases:

- in frontal or rear-end impacts exceeding a preset severity level
- if the restraint systems are operational and functioning correctly, see **SRS** indicator lamp (> page 62)



The ETDs for the front seats will only activate if the front seat belts are fastened (latch plate properly inserted into buckle).

The ETDs for the rear seats will activate with or without the respective seat belts fastened.

In an impact, emergency tensioning devices remove slack from the belts. Belt force limiters reduce the force exerted by the seat belts on occupants during a crash.

Warning!



An emergency tensioning device (ETD) that was activated must be replaced.

When disposing of the emergency tensioning device, our safety instructions must be followed. These are available at your authorized Mercedes-Benz Center.

Automatic comfort-fit feature seat belt

An automatic comfort-fit feature for front seats reduces the retracting force of the seat belts when they are in normal use.

Active head restraints

The active head restraints are intended to offer the driver and front passenger increased protection from head and neck injury. In the event of a rear-end collision, the active head restraints on the driver's and front passenger's seats are designed to move forward in the direction of travel, providing the head with increased support earlier on in the collision sequence. The active head restraints move forward whether the seat is occupied or not.

Warning!



Only use seat or head restraint covers which have been tested and approved by Mercedes-Benz for your vehicle model. Using other seat or head restraint covers may interfere with or prevent the activation of the active head restraints. Contact your authorized Mercedes-Benz Center for availability.

Warning!



For your protection, drive only with properly positioned head restraints.

Adjust head restraint so that the center of the head restraint supports the back of the head at eye level. This will reduce the potential for injury to the head and neck in the event of an accident or similar situation.

Do not drive the vehicle without the seat head restraints. Head restraints are intended to help reduce injuries during an accident.

You cannot remove the active head restraint on the driver's and passenger's seats.

For removal of the active head restraints we recommend that you contact an authorized Mercedes-Benz Center.

For information on head restraint adjustment, see "Seats" (▷ page 37).

For information on resetting the activated active head restraints, see "Resetting activated head restraints" (▷ page 434).

Occupant safety

Roll bars

Warning!



Make sure nothing is blocking the roll bars' path of motion. Otherwise someone could be injured when the roll bars are raised. The head restraints should therefore always be in the raised position when the rear seat is occupied (▷ page 120).

The roll bars are integrated into the rear head restraints.

The roll bars raise automatically in an accident or in a critical driving situation.



When the roll bars are raised automatically, you will hear a ratcheting sound and the rear head restraints will also rise.

You can manually lower the roll bars again when the soft top is open (▷ page 424). With the soft top closed, contact an authorized Mercedes-Benz Center to have the roll bars lowered. Do not attempt to lower the roll bars manually with the soft top closed. Lowering the roll bars manually with the soft top closed may impair the function of the roll bars.



You cannot lower the rear head restraints with the rear head restraint lowering switch (▷ page 120) when the roll bars are in the raised position.

Also, you cannot operate the soft top using the soft top switch when the roll bars are in the raised position.

- If the soft top is open, you can manually lower the roll bars (▷ page 424).
- If the soft top is closed, contact an authorized Mercedes-Benz Center to have the roll bars lowered.

Warning!



If the yellow roll bar warning lamp  in the clock does not go out after starting the engine, or if it comes on while driving, then the roll bar system is not operating properly and may not activate in an accident. In this case, raise the roll bars manually before continuing to drive (▷ page 423).

For safety reasons, drive only with the roll bars raised until the malfunction is repaired. Have your vehicle checked at an authorized Mercedes-Benz Center.

Children in the vehicle

If an infant or child is traveling with you in the vehicle:

- Secure the child using an infant or child restraint appropriate to the age and size of the child.
- Make sure that the infant or child is properly secured at all times while the vehicle is in motion.

Infant and child restraint seats and information on choosing an appropriate restraint system can be obtained from any Mercedes-Benz Center.

Infant and child restraint systems

We recommend all infants and children be properly restrained at all times while the vehicle is in motion.

All lap-shoulder belts except the driver's seat belt have special seat belt retractors for secure fastening of child restraints.

To fasten a child restraint, follow child restraint instructions for mounting. Then pull the shoulder belt out completely and let it retract. During seat belt retraction, a ratcheting sound can be heard to indicate that the special seat belt retractor is activated. The belt is now locked. Push down on child restraint to take up any slack.

To deactivate, release seat belt buckle and let seat belt retract completely. The seat belt can again be used in the usual manner.



For information on LATCH-type child seat anchors (▷ page 83).



The use of infant or child restraints is required by law in all 50 states, the District of Columbia, the U.S. territories, and all Canadian provinces.

Infants and small children should be seated in an appropriate infant or child restraint system, properly secured by a lap / shoulder belt or, if so equipped, a lap shoulder belt and a child restraint lower anchorage system that complies with U.S. Federal Motor Vehicle Safety Standards 213 and 225 and Canadian Motor Vehicle Safety Standards 213 and 210.2.

Warning!



Never release the seat belt buckle while the vehicle is in motion, since the special seat belt retractor will be deactivated.

Occupant safety



A statement by the child restraint manufacturer of compliance with this standard can be found on the instruction label on the restraint and in the instruction manual provided with the restraint.

When using any infant, or toddler restraint, or booster seat, be sure to carefully read and follow all manufacturer's instructions for installation and use.

Please read and observe warning labels affixed to the inside of the vehicle and to infant or child restraints.

Warning!







According to accident statistics, children are safer when properly restrained in the rear seating positions than in the front seating position. Thus, we strongly recommend that children be placed in the rear seats whenever possible. Regardless of seating position, children 12 years old and under must be seated and properly secured in an appropriate infant or child restraint recommended for the size and weight of the child.

The infant or child restraint must be properly secured with the vehicle's seat belt or seat belt and lower anchors, fully in accordance with the child seat manufacturer's instructions.

Children can be killed or seriously injured by an inflating air bag. Note the following important information when circumstances

require you to place a child in the front passenger seat:

- Your vehicle is equipped with air bag technology designed to turn off the front passenger front air bag in your vehicle when the OCS senses the weight of a typical 12-month-old child or less along with the weight of a standard appropriate child restraint on the front passenger seat.
- A child in a rear-facing child restraint on the front passenger seat will be seriously injured or even killed if the front passenger front air bag inflates in a collision which could occur under some circumstances, even with the air bag technology installed in your vehicle. The only means to completely eliminate this risk is to never place a child in a rear-facing child restraint in the front seat. We therefore strongly recommend that you always place a child in a rear-facing child restraint in the back seat.

- If you must install a rear-facing child restraint on the front passenger seat because circumstances require you to do so, make sure that the  indicator lamp is illuminated, indicating that the front passenger front air bag is deactivated. Should the  indicator lamp not illuminate or go out while the restraint is installed, please check installation. Periodically check the  indicator lamp while driving to make sure the  indicator lamp is illuminated. If the  indicator lamp goes out or remains out, do not transport a child on the front passenger seat until the system has been repaired. A child in a rear-facing child restraint on the front passenger seat will be seriously injured or even killed if the front passenger front air bag inflates.

- If you have to place a child in a forward-facing child restraint on the front passenger seat, move the seat as far back as possible, use the proper child restraint recommended for the age, size and weight of the child, and secure child restraint with the vehicle's seat belt according to the child seat manufacturer's instructions. For children larger than the typical 12-month-old child, the front passenger front air bag may or may not be activated (▷ page 79).

Warning!



Infants and small children should never share a seat belt with another occupant. During an accident, they could be crushed between the occupant and seat belt.

A child's risk of serious or fatal injuries is significantly increased if the child restraints are not properly secured in the vehicle and/or the child is not properly secured in the child restraint.

Children too big for a toddler restraint must ride in seats using regular seat belts. Position shoulder belt across chest and shoulder, not face or neck. A booster seat may be necessary to achieve proper belt positioning for children from 41 lbs until they reach a height where a lap/shoulder belt fits properly without a booster.



Occupant safety

▷▷ When the child restraint is not in use, remove it from the vehicle or secure it with the seat belt to prevent the child restraint from becoming a projectile in the event of an accident.

Do not leave children unattended in the vehicle, even if the children are secured in a child restraint system. Unsupervised children in a child restraint system may use vehicle equipment and may cause an accident and/or serious personal injury.

Occupant Classification System

The Occupant Classification System (OCS) automatically turns the front passenger front air bag on or off based on the classified occupant weight category determined by weight sensor readings from the front passenger seat.



The system does not deactivate the head-thorax air bag and the emergency tensioning device.

Occupants must sit properly belted in a nearly upright position with their back against the seat backrest and feet on the floor to be correctly classified. If the occupant's weight is transferred to another object in the vehicle (e.g. by leaning on armrests), the OCS may not be able to properly approximate the occupant's weight category.





If your seat, including your trim cover and cushion needs to be serviced in any way, take the vehicle to an authorized Mercedes-Benz Center.

Only seat accessories approved by Mercedes-Benz may be used.

Both driver and the front passenger should always use the  indicator lamp as an indication of whether or not the front passenger is properly positioned.

Warning!







If the  indicator lamp illuminates when an adult or someone larger than a small individual is in the front passenger seat, have the front passenger re-position himself or herself in the seat until the  indicator lamp goes out.

More information about air bag display messages (▷ page 389).

In the event of a collision, the air bag control unit will not allow front passenger front air bag deployment when the OCS classified the front passenger seat occupant as being up to or less than the weight of a typical 12-month-old child in a standard child restraint or if the front passenger seat is sensed as being empty.

When the OCS senses that the front passenger seat occupant is classified as being up to or less than the weight of a typical 12-month-old child in a standard child restraint, the  indicator lamp will illuminate when the engine is started and remain illuminated, indicating that the front passenger front air bag is deactivated.

When the OCS senses that the front passenger seat is classified as being empty, the  indicator lamp will illuminate when the engine is started and remain illuminated, indicating that the front passenger front air bag is deactivated.

When the OCS senses that the front passenger seat occupant is classified as being heavier than the weight of a typical 12-month-old child seated in a standard child restraint or as being a small individual (such as a young teenager or a small adult), the  indicator lamp will illuminate for approximately six seconds when the engine is started and then, depending on occupant weight sensor readings from the seat, remain illuminated or go out. With the  indicator lamp illuminated, the front passenger front air bag is deactivated. With the  indicator lamp out, the front passenger front air bag is activated.

When the OCS senses that the front passenger seat occupant is classified as an adult or someone larger than a small individual, the  indicator lamp will illuminate for approximately six seconds when the engine is started and then go out, indicating that the front passenger front air bag is activated.

If the  indicator lamp is illuminated, the front passenger front air bag is deactivated and will not be deployed.

If the  indicator lamp is not illuminated, the front passenger front air bag is activated and will be deployed:

- in the event of certain frontal impacts
- if impact exceeds a preset deployment threshold
- independently of the head-thorax air bags and/or rear side impact air bags*.

If the front passenger front air bag is deployed, the rate of inflation will be influenced by:

- the rate of relevant vehicle deceleration as assessed by the air bag control unit
- front passenger's weight category as identified by the Occupant Classification System (OCS).

Occupant safety

Warning!







According to accident statistics, children are safer when properly restrained in the rear seating positions than in the front seating position. Thus, we strongly recommend that children be placed in the rear seats whenever possible. Regardless of seating position, children 12 years old and under must be seated and properly secured in an appropriate infant or child restraint recommended for the size and weight of the child.

The infant or child restraint must be properly secured with the vehicle's seat belt, or seat belt and lower anchors, fully in accordance with the child seat manufacturer's instructions.

Children can be killed or seriously injured by an inflating air bag. Note the following important information when circumstances

require you to place a child in the front passenger seat:

- Your vehicle is equipped with air bag technology designed to turn off the front passenger front air bag in your vehicle when the system senses the weight of a typical 12-month-old child or less along with the weight of a standard appropriate child restraint on the front passenger seat.
- A child in a rear-facing child restraint on the front passenger seat will be seriously injured or even killed if the front passenger front air bag inflates in a collision which could occur under some circumstances, even with the air bag technology installed in your vehicle. The only means to completely eliminate this risk is to never place a child in a rear-facing child restraint in the front seat. We therefore strongly recommend that you always place a child in a rear-facing child restraint in the back seat.

- If you must install a rear-facing child restraint on the front passenger seat because circumstances require you to do so, make sure that the  indicator lamp is illuminated, indicating that the front passenger front air bag is deactivated. Should the  indicator lamp not illuminate or go out while the restraint is installed, please check installation. Periodically check the  indicator lamp while driving to make sure the  indicator lamp is illuminated. If the  indicator lamp goes out or remains out, do not transport a child on the front passenger seat until the system has been repaired. A child in a rear-facing child restraint on the front passenger seat will be seriously injured or even killed if the front passenger front air bag inflates.

- If you have to place a child in a forward-facing child restraint on the front passenger seat, move the seat as far back as possible, use the proper child restraint recommended for the age, size and weight of the child, and secure child restraint with the vehicle's seat belt according to the child seat manufacturer's instructions. For children larger than the typical 12-month-old child, the front passenger front air bag may or may not be activated (▷ page 79).



Deployment of the driver front air bag does not mean that the front passenger front air bag also should have deployed.

The Occupant Classification System (▷ page 78) may have determined:

- that the seat was empty or occupied by the weight up to or less than that of a typical 12-month-old child seated in a

standard child restraint - both instances where the system suppresses deployment of the front passenger front air bag even though the impact met the criteria and was of sufficient severity to deploy the driver front air bag.

- that the seat was occupied by a small individual (such as a young teenager or a small adult) or a child weighing more than the weight of a typical 12-month-old child in a standard child restraint - instances where the system may suppress deployment of the front passenger front air bag even though the impact met the criteria and was of sufficient severity to deploy the driver front air bag.

The  indicator lamp is located in the center console.



① Front passenger front air bag off indicator lamp

The  indicator lamp ① will be illuminated, except with the SmartKey removed or in starter switch position 0.

Occupant safety

Warning!





If the **SRS** indicator lamp and the  indicator lamp are lit at the same time, there is a malfunction in the Occupant Classification System. The front passenger front air bag will be deactivated in this case.

In order to ensure proper operation of the air bag system and OCS:

- Have the system checked as soon as possible by qualified technicians. Contact an authorized Mercedes-Benz Center.
- Sit properly belted in a nearly upright position with your back against the seat backrest.
- Do not lean on the armrests or lift yourself from the seat by using the handle over the door as this may cause the OCS to be unable to correctly approximate the occupant weight category.

- Only have the seat repaired or replaced by an authorized Mercedes-Benz Center.
- Read and observe all warnings in this chapter.

Self-test Occupant Classification System

After turning the SmartKey in the starter switch to position **1** or **2** or pressing the KEYLESS-GO* start/stop button once or twice, the  indicator lamp located in the center console illuminates. If an adult occupant is properly sitting on the front passenger seat and the system senses the occupant as being an adult, the  indicator lamp will illuminate and go out after approximately six seconds.

If the seat is not occupied and the system senses the front passenger seat as being empty, the  indicator lamp will illuminate and not go out.

Warning!



If the  **PASS AIR BAG OFF** indicator lamp should not illuminate, the system is not functioning. You must see an authorized Mercedes-Benz Center before seating any child on the front passenger seat.

More information can be found in the “Practical hints” section (▷ page 381).

Warning!



Never place anything between seat cushion and child seat (e.g. pillow), since it reduces the effectiveness of the Occupant Classification System. The bottom of the child seat must make full contact with the passenger seat cushion. An incorrectly mounted child seat could cause injuries to the child in case of an accident, instead of increasing protection for the child.

Follow the manufacturer’s instructions for installation of child seats.

Child seat anchors – LATCH type

This vehicle is equipped with two LATCH (Lower Anchors and Tethers for Children) type anchors (at each of the rear seats) for the installation of a LATCH-type child seat with matching mounting fittings.

Depending on vehicle production date, your vehicle is equipped with either LATCH-type design A or B.



Your cabriolet does not have and is not required to have anchorage rings for a child seat's top tether strap in the rear seating positions. Child seats can be used with the seat belt, or lower anchor system and seat belt, fully in accordance with the child seat manufacturer's instructions.

Warning!



Children too big for a toddler restraint must ride in seats using regular seat belts.

Position shoulder belt across chest and shoulder, not face or neck.

A booster seat may be necessary to achieve proper belt positioning for children from 41 lbs until they reach a height where a lap/shoulder belt fits properly without a booster.

Install child seat according to manufacturer's instructions.

The child seat must be firmly attached in the right and left side anchor ②.

An incorrectly mounted child seat may come loose during an accident which could result in serious injury or death to the child.

Damaged or impact damaged child seats or child seat anchor fittings must be replaced.

Do not leave children unattended in the vehicle, even if the children are secured in a child restraint system.



The child seat must be firmly attached in the right and left side anchor ②.



Non-LATCH type child seats may also be used and can be installed using the vehicle's seat belt system (▷ page 69). Install child seat according to the manufacturer's instructions.

Occupant safety

LATCH-type anchors design A

The foldable LATCH-type anchors are located between the seat cushion and the backrest.

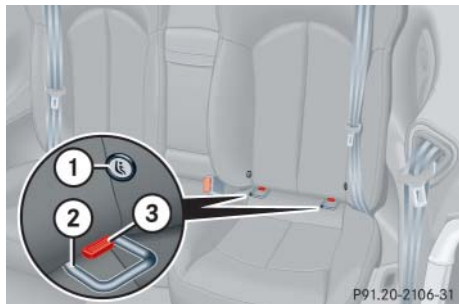

- ① Indicates the position of the anchors
- ② Anchors
- ③ Release button

To fold anchors out:

- ▶ Grip inner side of anchors ② and fold forward until they audibly lock in place.

Warning!



Before installing the child seat, make sure anchors ② are folded out and locked in place.

- ▶ Install child seat according to the manufacturer's instructions.



If a child seat is not installed, the LATCH-type anchors can be folded back between the seat cushion and the seat backrest.

To fold anchors back:

- ▶ Press down button ③ on each anchor ② and return the anchor ② to its catch.

LATCH-type anchors design B

The LATCH-type anchors are non-foldable and located between the seat cushion and the backrest.

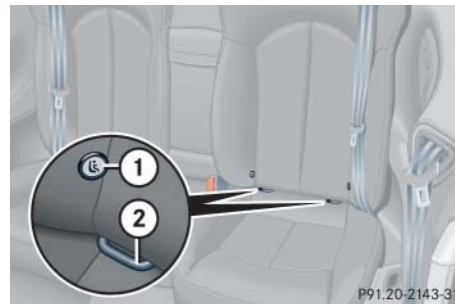

- ① Indicates the position of the anchors
- ② Anchors

- ▶ Install child seat according to the manufacturer's instructions.

Blocking of rear side window operation

You can block the rear side window operation (for instance when you have children riding in the rear passenger compartment).

The override switch is located on the door control panel of the driver's door.



- ① Deactivating override switch
- ② Activating override switch
- ③ Override switch

Warning!



Activate the override switch when children are riding in the back seats of the vehicle. The children may otherwise injure themselves, e.g. by becoming trapped in the window opening.

When leaving the vehicle, always remove the SmartKey or SmartKey with KEYLESS-GO* from the starter switch, take it with you, and lock the vehicle. Do not leave children unattended in the vehicle, or with access to an unlocked vehicle. Unsupervised use of vehicle equipment can cause an accident and/or serious personal injury.

Activating override switch

- ▶ Slide override switch ③ to the right in direction ②.

The rear side windows can no longer be operated using the respective switch located in the rear trim panels.



Operation of the rear side windows with the switches located on the door control panel of the driver's door is still possible.

Deactivating override switch

- ▶ Slide override switch ③ to the left in direction ①.

The rear side windows can be operated using the respective switch located in the rear trim panels.

For more information, see "Power windows" (▷ page 249).

Panic alarm

An audible alarm and flashing exterior lamps will operate for approximately 2¹/₂ minutes.



① **PANIC** button



USA only:

This device complies with Part 15 of the FCC Rules. Operation is subject to the following two conditions:

(1) This device may not cause harmful interference, and

(2) this device must accept any interference received, including interference that may cause undesired operation.

Any unauthorized modification to this device could void the user's authority to operate the equipment.



Canada only:

This device complies with RSS-210 of Industry Canada. Operation is subject to the following two conditions:

(1) This device may not cause interference, and

(2) this device must accept any interference received, including interference that may cause undesired operation of the device.

Any unauthorized modification to this device could void the user's authority to operate the equipment.

Activating

▶ Press and hold button ① for at least one second.

Deactivating

▶ Press button ① again.

or

▶ Insert the SmartKey or the SmartKey with KEYLESS-GO* in the starter switch.

or

▶ Press the KEYLESS-GO* start/stop button (▷ page 35).

The SmartKey with KEYLESS-GO* must be inside the vehicle.

▼ Driving safety systems

In this section you will find information on the following driving safety systems:

- ABS (Antilock Brake System)
- BAS (Brake Assist System)
- ESP® (Electronic Stability Program)



In winter operation, the maximum effectiveness of the ABS, the BAS, and the ESP® is only achieved with winter tires (▷ page 359) or snow chains as required.

Warning!



The following factors increase the risk of accidents:

- Excessive speed, especially in turns
- Wet and slippery road surfaces
- Following another vehicle too closely

The ABS, BAS, and ESP® cannot reduce this risk.

Always adjust your driving style to the prevailing road and weather conditions.

ABS

Warning!



Do not pump the brake pedal. Use firm, steady brake pedal pressure instead. Pumping the brake pedal defeats the purpose of the ABS and significantly reduces braking effectiveness.

The Antilock Brake System (ABS) regulates the brake pressure so that the wheels do not lock during braking. This allows you to maintain the ability to steer your vehicle.

The ABS is functional above a speed of approximately 5 mph (8 km/h) independent of road surface conditions.

On slippery road surfaces, the ABS will respond even to light brake pressure.

The  indicator lamp in the instrument cluster (▷ page 24) comes on when you switch on the ignition. It goes out when the engine is running.

Driving safety systems

Braking

At the instant one of the wheels is about to lock up, a slight pulsation can be felt in the brake pedal, indicating that the ABS is in the regulating mode.

- ▶ Keep firm and steady pressure on the brake pedal while experiencing the pulsation.

Continuous, steady brake pedal pressure yields the advantages provided by the ABS, namely braking power and the ability to steer the vehicle.

The pulsating brake pedal can be an indication of hazardous road conditions and functions as a reminder to take extra care while driving.

Emergency brake maneuver

- ▶ Keep continuous full pressure on the brake pedal.

Warning!



The ABS cannot prevent the natural laws of physics from acting on the vehicle, nor can it increase braking or steering efficiency beyond that afforded by the condition of the vehicle brakes and tires or the traction afforded. The ABS cannot prevent accidents, including those resulting from excessive speed in turns, following another vehicle too closely, or hydroplaning. Only a safe, attentive, and skillful driver can prevent accidents. The capabilities of an ABS equipped vehicle must never be exploited in a reckless or dangerous manner which could jeopardize the user's safety or the safety of others.

For more information, see “Practical hints” (▷ page 373).

BAS

The Brake Assist System (BAS) operates in emergency situations. If you apply the brakes very quickly, the BAS automatically provides full brake boost, thereby potentially reducing the braking distance. Apply continuous full braking pressure until the emergency braking situation is over. The ABS will prevent the wheels from locking.

When you release the brake pedal, the brakes function again as normal. The BAS is then deactivated.

Warning!



If the BAS is malfunctioning, the brake system is still functioning normally, but without the additional brake boost available that BAS would normally provide in an emergency braking maneuver. Therefore, the braking distance may increase.

Warning!

The BAS cannot prevent the natural laws of physics from acting on the vehicle, nor can it increase braking efficiency beyond that afforded by the condition of the vehicle brakes and tires or the traction. The BAS cannot prevent accidents, including those resulting from excessive speed in turns, following another vehicle too closely, or hydroplaning. Only a safe, attentive, and skillful driver can prevent accidents. The capabilities of a BAS equipped vehicle must never be exploited in a reckless or dangerous manner which could jeopardize the user's safety or the safety of others.

For more information, see “Practical hints” (▷ page 373).

ESP®

The Electronic Stability Program (ESP®) is operational as soon as the engine is running and monitors the vehicle's traction (force of adhesive friction between the tires and the road surface) and handling.

The ESP® recognizes when a wheel is spinning or if the vehicle starts to skid. By applying brakes to the appropriate wheel and by limiting the engine output, the ESP® works to stabilize the vehicle. The ESP® is especially useful while driving off and on wet or slippery road surfaces. The ESP® also stabilizes the vehicle during braking maneuvers.

The ESP® warning lamp  in the instrument cluster flashes when the ESP® is engaged.

The warning lamp  in the instrument cluster comes on when you switch on the ignition. It goes out when the engine is running.

Warning!

Never switch off the ESP® when you see the ESP® warning lamp  flashing in the instrument cluster. In this case, proceed as follows:

- While driving off, apply as little throttle as possible.
- While driving, ease upon the accelerator.
- Adapt your speed and driving style to the prevailing road conditions.

Failure to observe these guidelines could cause the vehicle to skid.

The ESP® cannot prevent accidents resulting from excessive speed.

Warning!



The ESP® cannot prevent the natural laws of physics from acting on the vehicle, nor can it increase the traction afforded. The ESP® cannot prevent accidents, including those resulting from excessive speed in turns or hydroplaning. Only a safe, attentive, and skillful driver can prevent accidents. The capabilities of an ESP® equipped vehicle must never be exploited in a reckless or dangerous manner which could jeopardize the user's safety or the safety of others.



Because of the ESP®'s automatic operation, the engine must be shut off when

- the parking brake is being tested on a brake test dynamometer
- the vehicle is being towed with the front axle raised

Active braking action through the ESP® may otherwise seriously damage the brake system.



The ESP® will only function properly if you use wheels of the recommended tire size.

For more information, see “Practical hints” (▷ page 373).

Switching off the ESP®

Warning!



The ESP® should not be switched off during normal driving other than in the circumstances described below. Disabling of the system will reduce vehicle stability in standard driving maneuvers.

Do not switch off the ESP® when a Minispare or collapsible tire is mounted.

To improve the vehicle's traction, turn off the ESP® in driving situations where it would be advantageous to have the drive wheels spin and thus cut into surfaces for better grip such as:

- when driving with snow chains
- in deep snow
- in sand or gravel



Turn on the ESP® immediately if the aforementioned circumstances do not apply anymore.

When you switch off the ESP®

- the ESP® does not stabilize the vehicle
- the engine output is not limited, which allows the drive wheels to spin and thus cut into surfaces for better grip
- the traction control will still brake a spinning wheel
- the ESP® continues to operate when you are braking



When the ESP® is switched off and one or more drive wheels are spinning, the ESP® warning lamp  in the instrument cluster flashes. However, the ESP® will then not stabilize the vehicle.

The switch is located on the center console.



① ESP® switch (off/on)

- ▶ Press switch ①.

The ESP® warning lamp  in the instrument cluster comes on.

The ESP® is deactivated.

Warning!



When the ESP® warning lamp  is illuminated continuously, the ESP® is switched off.

Adapt your speed and driving to the prevailing road conditions and to the non-operating status of the ESP®.



Avoid spinning of a drive wheel for an extended period with the ESP® switched off. This may cause serious damage to the drivetrain which is not covered by the Mercedes-Benz Limited Warranty.

Switching on the ESP®

- ▶ Press switch ① again.

The ESP® warning lamp  in the instrument cluster goes out.

You are now again in normal driving mode with ESP® switched on.

Anti-theft systems

Immobilizer

The immobilizer prevents unauthorized persons from starting your vehicle.

Activating

With the SmartKey

- ▶ Remove the SmartKey from the starter switch.

*With KEYLESS-GO**

- ▶ Turn off the engine by means of the start/stop button (▷ page 35) on the gear selector lever.
- ▶ Open the driver's door.

Deactivating

With the SmartKey

- ▶ Insert the SmartKey in the starter switch.

*With KEYLESS-GO**

- ▶ Switch on the ignition (▷ page 36).



Starting the engine will also deactivate the immobilizer.

In case the engine cannot be started (yet the vehicle's battery is charged), the system is not operational. Contact an authorized Mercedes-Benz Center or call 1-800-FOR-MERCEdes (in the USA), or 1-800-387-0100 (in Canada).

Anti-theft alarm system

Once the alarm system has been armed, a visual and audible alarm is triggered when someone opens

- a door
- the trunk
- the hood.

The alarm will stay on even if the activating element (a door, for example) is immediately closed.

The alarm system will also be triggered when

- someone attempts to raise the vehicle.
- the vehicle is opened with the mechanical key.
- someone opens a door from the inside.
- someone opens the trunk with the emergency release button.



If the alarm stays on for more than 30 seconds, a call to the Response Center is initiated automatically by the Tele Aid system (▷ page 289) provided Tele Aid service was subscribed to and properly activated, and that necessary cellular service and GPS coverage are available.

Arming the alarm system

The indicator lamp is in the switch for the tow-away alarm in the center console.



① Indicator lamp

- ▶ Lock the vehicle with the SmartKey or KEYLESS-GO*.

The turn signal lamps flash three times to indicate that the alarm system is activated. Indicator lamp ① begins to flash after approximately 30 seconds after arming the alarm system.



If the turn signal lamps do not flash three times, one of the following elements may not be properly closed:

- a door
- the trunk

Close the respective element and lock the vehicle again.

Disarming the alarm system

- ▶ Unlock the vehicle with the SmartKey or KEYLESS-GO*.



The turn signal lamps flash once to indicate that the alarm system is disarmed.



The alarm system will rearm automatically after approximately 40 seconds if neither a door nor the trunk lid was opened.

Canceling the alarm

With the SmartKey

- ▶ Press the  or  button on the SmartKey.

or

- ▶ Insert the SmartKey in the starter switch.

*With KEYLESS-GO**

- ▶ Pull an outside door handle.

The SmartKey with KEYLESS-GO must be within 3 ft (1 m) of the vehicle.

or

- ▶ Press the KEYLESS-GO start/stop button.

The SmartKey with KEYLESS-GO must be inside the vehicle.

Anti-theft systems

Tow-away alarm

Once the tow-away alarm is armed, a visual and audible alarm will be triggered when someone attempts to raise the vehicle.



The tow-away protection alarm is triggered, for example, if the vehicle is lifted on one side.

If the alarm stays on for more than 30 seconds, a call to the Response Center is initiated automatically by the Tele Aid system (▷ page 289) provided Tele Aid service was subscribed to and properly activated, and that necessary cellular service and GPS coverage are available.

Arming tow-away alarm

- ▶ Lock the vehicle with the SmartKey or KEYLESS-GO*.

The tow-away alarm is automatically armed after about 30 seconds.



When you unlock the vehicle, the tow-away protection disarms automatically. The tow-away alarm remains disarmed until you lock the vehicle again.

Disarming tow-away alarm

To prevent triggering the tow-away alarm, switch off the tow-away alarm feature before towing the vehicle, or when parking on a surface subject to movement, such as a ferry or auto train.



- ① Tow-away alarm off switch
- ② Indicator lamp

- ▶ Switch off the ignition and remove the SmartKey.



You cannot disarm the tow-away alarm while the ignition is switched on.

- ▶ Press switch ①.

Indicator lamp ② in switch ① comes on briefly.

- ▶ Exit and lock the vehicle with the SmartKey or (vehicles with KEYLESS-GO*) the lock button on each outside door handle or trunk.

The tow-away alarm remains disarmed until you lock the vehicle again.

Locking and unlocking

Seats

Memory function

Lighting

Instrument cluster

Control system

Automatic transmission

Good visibility

Climate control (CLK 350)

Automatic climate control (CLK 500/CLK 55 AMG)

Audio system

Power windows

Soft top

Driving systems

Loading

Useful features

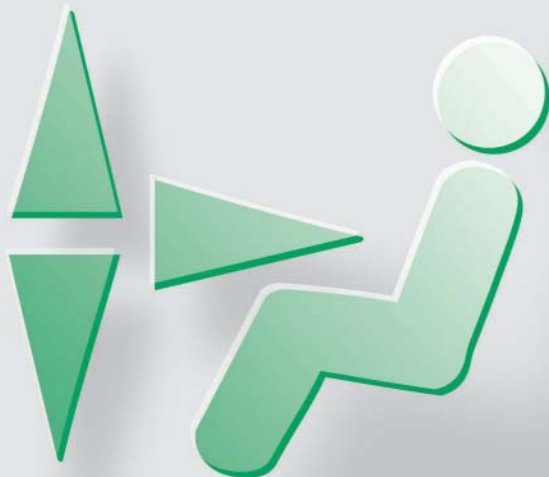

Locking and unlocking

In the “Controls in detail” section you will find detailed information on how to operate the equipment installed in your vehicle. If you are already familiar with the basic functions of your vehicle, this section will be of particular interest to you.

To quickly familiarize yourself with the basic functions of the vehicle, refer to the “Getting started” section of this manual. The corresponding page numbers are given at the beginning of each segment.

For more information on locking and unlocking, see “Getting started” (▷ page 32) and (▷ page 57).

SmartKey

Your vehicle comes supplied with two SmartKeys, each with remote control and a removable mechanical key.

The locking tabs for the mechanical key portion of the two SmartKeys are a different color to help distinguish each SmartKey unit.



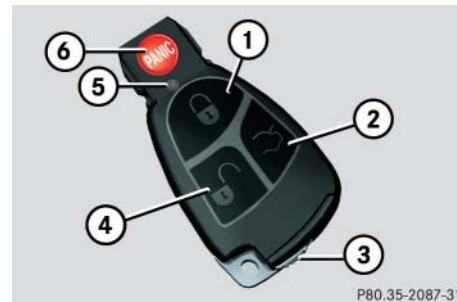

The SmartKey provides an extended operating range. To prevent theft, however, it is advisable to only unlock the vehicle when you are in close proximity to it.

The SmartKey centrally locks and unlocks:

- the doors
- the glove box
- the trunk
- the fuel filler flap



SmartKey with remote control

- ①  Lock button
- ②  Opening button for trunk
- ③  Mechanical key locking tab
- ④  Unlock button
- ⑤  Battery check lamp
- ⑥  PANIC (▷ page 86)

Warning!

When leaving the vehicle, always remove the SmartKey from the starter switch, take it with you, and lock the vehicle. Do not leave children unattended in the vehicle, or with access to an unlocked vehicle. It is possible for children to open a locked door from the inside, which could result in an accident and/or serious injury.



To prevent possible malfunction, avoid exposing the SmartKey to high levels of electromagnetic radiation.



USA only:

This device complies with Part 15 of the FCC Rules. Operation is subject to the following two conditions:

- (1) This device may not cause harmful interference, and
- (2) this device must accept any interference received, including interference that may cause undesired operation.

Any unauthorized modification to this device could void the user's authority to operate the equipment.



Canada only:

This device complies with RSS-210 of Industry Canada. Operation is subject to the following two conditions:

- (1) This device may not cause interference, and
- (2) this device must accept any interference received, including interference that may cause undesired operation of the device.

Any unauthorized modification to this device could void the user's authority to operate the equipment.



You can also open and close the soft top, see “Opening and closing the soft top with the SmartKey” (▷ page 260), and the power windows using the SmartKey, see “Summer opening feature” (▷ page 252) and see “Convenience closing feature” (▷ page 253).

Locking and unlocking

Factory setting

Global unlocking

- ▶ Press button .

All turn signal lamps flash once. The locking knobs in the doors move up. The anti-theft alarm system is disarmed.

The vehicle will lock again automatically and rearm the anti-theft alarm system within approximately 40 seconds of unlocking if:

- neither a door nor the trunk is opened
- the SmartKey is not inserted in the starter switch
- the central locking switch is not activated



Global locking

- ▶ Press button .

With the trunk and both doors closed, all turn signal lamps flash three times. The locking knobs in the doors move down. The anti-theft alarm system is armed.

Selective setting

If you frequently travel alone, you may wish to reprogram the SmartKey so that pressing  only unlocks the driver's door and the fuel filler flap.

- ▶ Press and hold buttons  and  simultaneously for about 5 seconds until battery check lamp  flashes twice.

The SmartKey will then function as follows:

Unlocking driver's door and fuel filler flap

- ▶ Press button  once.

All turn signal lamps flash once. The locking knob in the driver's door moves up. The anti-theft alarm system is disarmed.

Global unlocking

- ▶ Press button  twice.



All turn signal lamps flash once. The locking knobs in the doors move up. The anti-theft alarm system is disarmed.

Global locking

- ▶ Press button .

With the trunk and both doors closed, all turn signal lamps flash three times. The locking knobs in the doors move down. The anti-theft alarm system is armed.

Restoring to factory setting

- ▶ Press and hold buttons  and  simultaneously for about 6 seconds until battery check lamp  flashes twice.



If you can no longer lock or unlock the vehicle with the SmartKey, then the batteries in the SmartKey are discharged, the SmartKey is malfunctioning or the vehicle battery is drained.

- Check the batteries in the SmartKey (▷ page 99) and replace them if necessary (▷ page 435).
- Use the mechanical key to unlock the driver's door (▷ page 419) and the trunk (▷ page 420).
- Use the mechanical key to lock the driver's door (▷ page 420) and the trunk (▷ page 116).
- Have the vehicle battery and the battery connections checked (▷ page 453).

If the SmartKey is malfunctioning, contact an authorized Mercedes-Benz Center.

Checking the batteries

- ▶ Press button  or .

Battery check lamp  comes on briefly to indicate that the SmartKey batteries are in order.





If battery check lamp  does not come on briefly during check, then the SmartKey batteries are discharged.

Replace the batteries (▷ page 435).

You can obtain the required batteries at any authorized Mercedes-Benz Center.



If the batteries are checked within signal range of the vehicle, pressing the  or  button will lock or unlock the vehicle accordingly.

Unlocking and opening the trunk

You can unlock and open the trunk separately.

A minimum height clearance of 5.41 ft (1.65 m) is required to open the trunk lid.

- ▶ Press and hold button  until trunk unlocks and begins to open.



The trunk lid swings open upwards automatically. Always make sure there is sufficient overhead clearance.

Vehicles with trunk opening/closing system*: To stop the opening procedure, press button . The trunk lid stops moving.



If the trunk does not open, it is still locked separately (▷ page 116).

The trunk can also be opened from its inside in an emergency, see "Trunk emergency release" (▷ page 115).

Locking and unlocking

Loss of SmartKey or mechanical key

If you lose a SmartKey or mechanical key, you should do the following:

- ▶ Have the SmartKey deactivated by an authorized Mercedes-Benz Center.
- ▶ Report the loss of the SmartKey or the mechanical key immediately to your car insurance company.
- ▶ If necessary, have the mechanical lock replaced.

Your authorized Mercedes-Benz Center will be glad to supply you with a replacement.

SmartKey with KEYLESS-GO*

Vehicles equipped with KEYLESS-GO come with two SmartKeys with KEYLESS-GO, each with remote control and a removable mechanical key.

The locking tabs for the mechanical key portion of the two SmartKeys with KEYLESS-GO are a different color to help distinguish each SmartKey with KEYLESS-GO unit.



The KEYLESS-GO function is integrated into the SmartKey. On these vehicles, the validity of the SmartKey with KEYLESS-GO is checked every time you pull an outside door handle.

If the SmartKey with KEYLESS-GO is valid, your vehicle unlocks

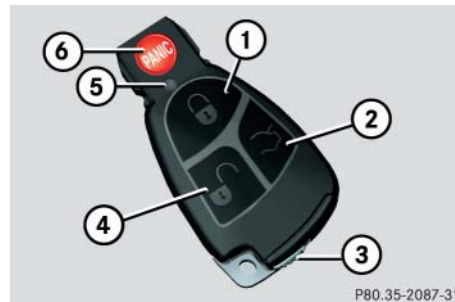
- the doors
- the glove box
- the trunk
- the fuel filler flap



SmartKey with KEYLESS-GO

- ①  Lock button
- ②  Opening button for trunk
- ③ Mechanical key locking tab
- ④  Unlock button
- ⑤ Battery check lamp
- ⑥  PANIC (▷ page 86)



When the passenger outside door handle is pulled, the vehicle is centrally unlocked.

Warning!

When leaving the vehicle, always take the SmartKey with KEYLESS-GO* with you, and lock the vehicle. Do not leave children unattended in the vehicle, or with access to an unlocked vehicle. Unsupervised use of vehicle equipment may cause an accident and/or serious personal injury.



To prevent possible malfunction, avoid exposing the SmartKey with KEYLESS-GO to high levels of electromagnetic radiation.



USA only:

This device complies with Part 15 of the FCC Rules. Operation is subject to the following two conditions:

- (1) This device may not cause harmful interference, and
- (2) this device must accept any interference received, including interference that may cause undesired operation.

Any unauthorized modification to this device could void the user's authority to operate the equipment.



Canada only:

This device complies with RSS-210 of Industry Canada. Operation is subject to the following two conditions:

- (1) This device may not cause interference, and
- (2) this device must accept any interference received, including interference that may cause undesired operation of the device.

Any unauthorized modification to this device could void the user's authority to operate the equipment.



You can also open and close the soft top and the power windows using the SmartKey with KEYLESS-GO, see “Summer opening feature” (▷ page 252) and see “Convenience closing feature” (▷ page 253).

Locking and unlocking

Important notes on using KEYLESS-GO*

- You can also use the SmartKey with KEYLESS-GO like a normal SmartKey (▷ page 96).
 - You can combine KEYLESS-GO functions with normal SmartKey functions (e.g. unlocking with KEYLESS-GO and locking with the  button).
 - Always carry the SmartKey with KEYLESS-GO with you.
 - Never store the SmartKey with KEYLESS-GO together with:
 - electronic items such as a cellular phone or another SmartKey with KEYLESS-GO.
 - metallic objects such as coins or metal foil.
- Doing so could impair the function of the KEYLESS-GO system.
- To lock or unlock the vehicle, the SmartKey with KEYLESS-Go must be located outside the vehicle within approximately 3 ft (1 m) of a door or the trunk lid.
 - In order to start the engine with the SmartKey with KEYLESS-GO:
 - The SmartKey with KEYLESS-GO must be located in the vehicle.
 - All doors must be closed.
 - The brake pedal must be firmly depressed. Do not depress the accelerator.
 - If you have started the engine with the KEYLESS-GO start/stop button (▷ page 35), you can only turn it off again with this button, even if you have put the SmartKey in the starter switch in the meantime.

- This does not apply if, after starting, the gear selector lever is still in position **P**. and the SmartKey is then inserted in the starter switch. The SmartKey will then have priority over the KEYLESS-GO function and the vehicle's electrical system will operate according to the position of the SmartKey in the starter switch, even stopping the engine.
- If the SmartKey with KEYLESS-GO is positioned farther away from the vehicle, the system may no longer recognize the SmartKey with KEYLESS-GO. The vehicle then cannot be locked or the engine started via the KEYLESS-GO system.

- If the SmartKey with KEYLESS-GO is removed from the vehicle while the ignition is switched on (e.g. if passenger exits the vehicle with the SmartKey with KEYLESS-GO), the message

Key not recognized

will appear in the multifunction display while driving off.

Find the SmartKey with KEYLESS-GO or change its present location immediately (e.g. place it on the front passenger seat or insert it in shirt pocket).

- Remember that the engine can be started by anyone with a SmartKey with KEYLESS-GO that is left inside the vehicle. If you leave the SmartKey with KEYLESS-GO behind when exiting and locking the vehicle, the message

Key recognized in vehicle

will appear in the multifunction display.

Factory setting

Warning!



When leaving the vehicle, always take the SmartKey with KEYLESS-GO* with you, and lock the vehicle. Do not leave children unattended in the vehicle, or with access to an unlocked vehicle. It is possible for children to open a locked door from the inside, which could result in an accident and/or serious personal injury.

Global unlocking

- ▶ Pull an outside door handle.

All turn signal lamps flash once. The locking knobs in the doors move up. The anti-theft alarm system is disarmed.



If the vehicle has been parked for a longer period of time, you must pull an outside door handle in order to activate the KEYLESS-GO function.

The vehicle will lock again automatically and reactivate the anti-theft alarm system within approximately 40 seconds of unlocking if:

- neither a door nor the trunk is opened.
- the central locking switch is not activated.



The vehicle could inadvertently be unlocked if the SmartKey with KEYLESS-GO is within 3 ft (1 m) of the vehicle and:

- an outside door handle is splashed with water, or
- you attempt to clean an outside door handle.

Locking and unlocking



Global locking

- ▶ Press the lock button on an outside door handle (▷ page 60) or the trunk lid (▷ page 106).

With the trunk and both doors closed, all turn signal lamps flash three times. The locking knobs in the doors move down. The anti-theft alarm system is armed.

Selective setting

If you frequently travel alone, you may wish to reprogram the SmartKey with KEYLESS-GO so when you, pull the driver's door handle only the driver's door and the fuel filler flap unlocks.

- ▶ Press and hold buttons  and  simultaneously for about 5 seconds until battery check lamp  flashes twice.

The SmartKey with KEYLESS-GO will then function as follows:

Unlocking driver's door and fuel filler flap

- ▶ Pull the driver's outside door handle.
All turn signal lamps flash once. The locking knob in the driver's door moves up. The anti-theft alarm system is disarmed.

Global unlocking

- ▶ Pull the outside door handle on the passenger side.

All turn signal lamps flash once. The locking knobs in the doors move up. The anti-theft alarm system is disarmed.

Global locking



- ▶ Press the lock button on an outside door handle.

With the trunk and both doors closed, all turn signal lamps flash three times. The locking knobs in the doors move down. The anti-theft alarm system is armed.



You can also lock the vehicle using the lock button on the trunk lid, (▷ page 106) or, vehicles with trunk opening/closing*, KEYLESS-GO lock-opening/closing switch (▷ page 114).

Restoring to factory setting

- ▶ Press and hold buttons  and  simultaneously for about 6 seconds until battery check lamp  flashes twice.



If you can no longer lock or unlock the vehicle with the SmartKey with KEYLESS-GO, then the batteries in the SmartKey with KEYLESS-GO are discharged, the SmartKey with KEYLESS-GO is malfunctioning or the vehicle battery is drained.

- Check the batteries in the SmartKey with KEYLESS-GO (▷ page 105) and replace them if necessary (▷ page 435).
- Use the mechanical key to unlock the driver's door (▷ page 419) and the trunk (▷ page 420).
- Use the mechanical key to lock the driver's door (▷ page 420) and the trunk (▷ page 116).

- Have the vehicle battery and the battery connections checked (▷ page 453).

If the SmartKey with KEYLESS-GO is malfunctioning, contact an authorized Mercedes-Benz Center.

Checking the batteries

- ▶ Press button  or .

Battery check lamp  comes on briefly to indicate that the SmartKey with KEYLESS-GO batteries are in order.





If battery check lamp  does not come on briefly during check, then the SmartKey with KEYLESS-GO batteries are discharged.

Replace the batteries (▷ page 435).

You can obtain the required batteries at any authorized Mercedes-Benz Center.



If the batteries are checked within signal range of the vehicle, pressing the  or  button will lock or unlock the vehicle accordingly.

Global locking using the lock button on the trunk lid

To prevent a possible inadvertent lockout, the trunk will open automatically if a SmartKey with KEYLESS-GO* is recognized inside the vehicle or in the trunk.

Locking and unlocking

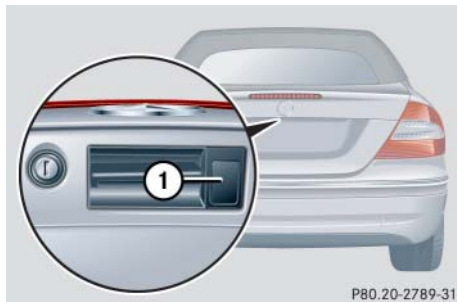

① Lock button

- ▶ Press lock button ① on the trunk lid.

With the trunk and both doors closed, all turn signal lamps flash three times. The locking knobs in the doors move down. The anti-theft alarm system is armed.



You can also lock the vehicle using the lock button on an outside door handle (▷ page 60) or, vehicles with trunk opening/closing system*, KEYLESS-GO locking/closing switch (▷ page 114).

Unlocking and opening the trunk

You can unlock and open the trunk separately.

A minimum height clearance of 5.41 ft (1.65 m) is required to open the trunk lid.

- ▶ Press and hold button  until trunk unlocks and begins to open.



The trunk lid swings open upwards automatically. Always make sure there is sufficient overhead clearance.

Vehicles with trunk opening/closing system*: To stop the opening procedure, press button . The trunk lid stops moving.



If the trunk does not open, it is still locked separately (▷ page 116).

The trunk can also be opened from its inside in an emergency, see “Trunk emergency release” (▷ page 115).

Loss of the SmartKey with KEYLESS-GO

If you lose your SmartKey with KEYLESS-GO, you should do the following:

- ▶ Have the SmartKey with KEYLESS-GO deactivated by an authorized Mercedes-Benz Center.
- ▶ Report the loss of the SmartKey with KEYLESS-GO or the mechanical key immediately to your car insurance company.
- ▶ Have the mechanical lock replaced if necessary.

Your authorized Mercedes-Benz Center will be glad to supply you with a replacement.

Opening the doors from the inside

You can open a locked door from the inside. Open doors only when conditions are safe to do so.

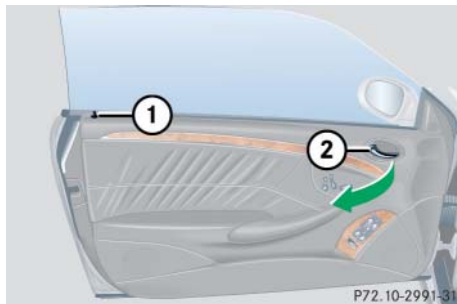

- ① Locking knob
- ② Inside door handle



► Pull on door handle ②.

If door was locked, locking knob ① will move up.



If the vehicle has previously been locked with the SmartKey or KEYLESS-GO*, opening a door from the inside will trigger the anti-theft alarm system.

To cancel the alarm, do one of the following:

- Insert the SmartKey in the starter switch.
- Press button  or  on the SmartKey.

In vehicles with KEYLESS-GO*:

- Pull an outside door handle.

The SmartKey with KEYLESS-GO must be within 3 ft (1 m) of the vehicle.

- Press the KEYLESS-GO* start/stop button (▷ page 35).

The SmartKey with KEYLESS-GO must be inside the vehicle.



If you open a door, the side windows on that side of the vehicle will lower slightly. The windows close again when you close the door.

Locking and unlocking

Opening the trunk

Opening the trunk from outside

A minimum height clearance of 5.41 ft (1.65 m) is required to open the trunk lid.

Vehicles without KEYLESS-GO*:
The vehicle must be unlocked.

The handle is located in the rear license plate recess.

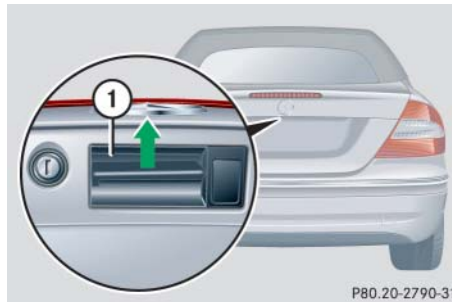

① Handle

► Pull on handle ①.

The trunk opens.



The trunk lid swings open upwards automatically. Always make sure there is sufficient overhead clearance.

Vehicles with trunk opening/closing system*: To stop the opening procedure, press button  on the SmartKey or SmartKey with KEYLESS-GO*.



If the trunk does not open, it is still locked separately (▷ page 116).



The trunk can also be opened using button  on the SmartKey or SmartKey with KEYLESS-GO* or from its inside in an emergency, see “Trunk emergency release” (▷ page 115).

Opening the trunk from the inside

You can open the trunk from the inside if the vehicle is stationary.

A minimum height clearance of 5.41 ft (1.65 m) is required to open the trunk lid.

The remote trunk opening switch is located on the driver's door (vehicles without trunk opening/closing system*).



① Remote trunk opening switch

The remote trunk opening switch and the trunk closing switch are located on the driver's door (vehicles with trunk opening/closing system*).



- ① Remote trunk opening switch*
- ② Remote trunk closing switch*

- ▶ Press remote trunk opening switch ① until the trunk begins to open.

The trunk opens. The indicator lamp comes on and remains lit until the trunk is closed.



The trunk lid swings open upwards automatically. Always make sure there is sufficient overhead clearance.

Vehicles with trunk opening/closing system*: To stop the opening procedure, press switch ① or ②.



If the trunk does not open, it is still locked separately (▷ page 116).



The trunk can also be opened using button  on the SmartKey or SmartKey with KEYLESS-GO* or from its inside in an emergency, see "Trunk emergency release" (▷ page 115).

Locking and unlocking

Closing the trunk

Closing the trunk from the inside automatically*

In vehicles with trunk opening/closing system* you can close the trunk from the inside using the remote trunk closing* switch.

- ▶ Press the remote trunk closing* switch ② (▷ page 109) until the indicator lamp in the switch goes out and the trunk lid is closed.

To interrupt the closing procedure:

- ▶ Release remote trunk closing* switch ②.



You can also close the trunk by hand (▷ page 111).

Warning!



Maintain sight of trunk area while operating the door mounted remote trunk closing* switch. Monitor the closing procedure carefully to ensure that no one is in danger of being injured.

To interrupt the closing procedure, release the door mounted remote trunk closing switch.

Even with the SmartKey or the SmartKey with KEYLESS-GO* removed from the start-er switch or the SmartKey with KEYLESS-GO* removed from the vehicle, the remote trunk opening/closing* switch can be operated. Therefore, do not leave children unattended in the vehicle, or with access to an unlocked vehicle. Unsupervised use of vehicle equipment may cause an accident and/or serious personal injury.

Warning!



Only drive with the trunk closed as, among other dangers such as blocked visibility, exhaust fumes may enter the vehicle interior.

If the trunk lid comes into contact with an object while closing (e.g. luggage that has been piled too high), in the sequence, the upper motion the closing procedure is stopped and the trunk reopens slightly.

Closing the trunk from the outside manually

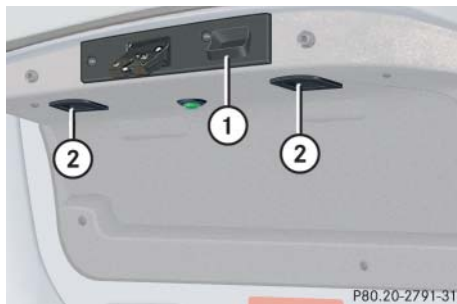

- ① Handle
- ② Handles

- ▶ Lower trunk lid by pulling firmly on handle ① or handles ②.
- ▶ Close trunk from the outside with hands placed flat on the trunk lid.

Warning!



To prevent possible personal injury, always keep hands and fingers away from the trunk lid opening when closing the trunk. Be especially careful when small children are around.

When leaving the vehicle, always remove the SmartKey or SmartKey with KEYLESS-GO* from the starter switch, take it with you, and lock the vehicle. Do not leave children unattended in the vehicle, or with access to an unlocked vehicle. It is possible for children to open a locked door from the inside, which could result in an accident and/or serious personal injury.

Warning!



Only drive with the trunk closed as, among other dangers such as blocked visibility, exhaust fumes may enter the vehicle interior.



Do not place the SmartKey in the open trunk. You may lock yourself out.

Vehicles with KEYLESS-GO*:
To prevent a possible inadvertent lock-out, the trunk lid will open automatically if a SmartKey with KEYLESS-GO* is recognized inside the vehicle or in the trunk.



If the vehicle was previously centrally locked, the trunk will lock automatically after closing it (▷ page 110). All turn signal lamps flash three times to confirm locking.

Locking and unlocking

Closing the trunk from outside (vehicles without KEYLESS-GO*)

In vehicle with trunk opening/closing system* you can close the trunk separately

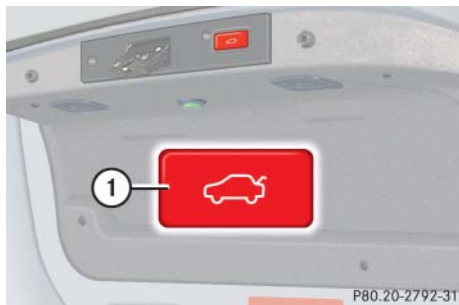

① Trunk closing switch

- ▶ Press trunk closing switch ① briefly. The trunk closes.



You can also close the trunk by hand (▷ page 111).

If the trunk lid comes into contact with an object while closing (e.g. luggage that has been piled too high), the closing procedure is stopped and the trunk reopens slightly.

Warning!



Monitor the closing procedure carefully to ensure that no one is in danger of being injured. To prevent possible personal injury, always keep hands and fingers away from the trunk opening when closing the trunk. Be especially careful when small children are around. To stop the closing procedure, do one of the following:

- press trunk closing switch ①
- press the  button on the SmartKey
- press the remote trunk opening or closing switch (on driver's door)

Even with the SmartKey removed from the starter switch, the trunk closing switch can be operated. Therefore, do not leave children unattended in the vehicle,

or with access to an unlocked vehicle. Unsupervised use of vehicle equipment may cause an accident and/or serious personal injury.

Warning!



Only drive with the trunk closed as, among other dangers such as blocked visibility, exhaust fumes may enter the vehicle interior.



Do not place the SmartKey in the open trunk. You may lock yourself out.



If the vehicle was previously centrally locked, the trunk will lock automatically after closing it (▷ page 110). All turn signal lamps flash three times to confirm locking.

Closing the trunk from the outside (vehicles with KEYLESS-GO*)

In vehicles with trunk opening/closing system* you can close the trunk separately.

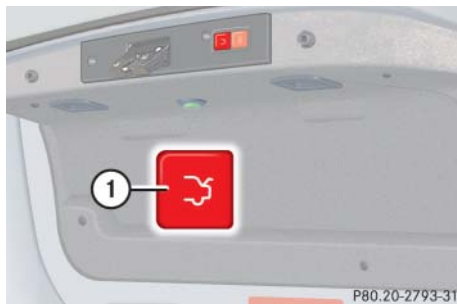

① Trunk closing switch

- ▶ Make sure you have the SmartKey with KEYLESS-GO with you.
- ▶ Press trunk closing switch ① briefly.
The trunk closes.



You can also close the trunk by hand (▷ page 111).

If the trunk lid comes into contact with an object while closing (e.g. luggage that has been piled too high), the closing procedure is stopped and the trunk reopens slightly.



To prevent a possible inadvertent lock-out, the trunk will open automatically if a SmartKey with KEYLESS-GO* is recognized inside the vehicle or in the trunk.

Warning!



Monitor the closing procedure carefully to ensure that no one is in danger of being injured. To prevent possible personal injury, always keep hands and fingers away from the trunk opening when closing the trunk. Be especially careful when small children are around. To stop the closing procedure, do one of the following:

- press trunk closing switch ①
- press KEYLESS-GO locking/closing switch
- press the  button on the SmartKey with KEYLESS-GO
- press the remote trunk opening or closing switch (on driver's door)



Locking and unlocking

- ▷▷ Even with the SmartKey with KEYLESS-GO removed from the vehicle, the trunk closing switch can be operated. Therefore, do not leave children unattended in the vehicle, or with access to an unlocked vehicle. Unsupervised use of vehicle equipment may cause an accident and/or serious personal injury.

Warning!



Only drive with the trunk closed as, among other dangers such as blocked visibility, exhaust fumes may enter the vehicle interior.



If the vehicle was previously centrally locked, the trunk will lock automatically after closing it (▷ page 110). All turn signal lamps flash three times to confirm locking.

Closing the trunk and locking the vehicle from the outside (vehicles with KEYLESS-GO*)

In vehicles with trunk opening/closing system* and KEYLESS-GO, you can close the trunk lid and lock the vehicle simultaneously.

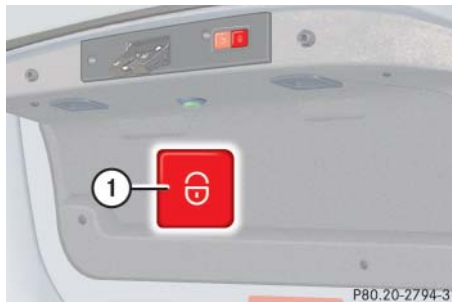

① KEYLESS-GO locking/closing switch

- ▶ Make sure you have the SmartKey with KEYLESS-GO with you.

- ▶ Press switch ① briefly.

The vehicle is locked and the trunk closes automatically.

With both doors closed, all turn signal lamps flash three times to confirm locking. The locking knobs in the doors move down. The anti-theft alarm system is armed.



You can also close the trunk by hand (▷ page 111).

If the trunk lid comes into contact with an object while closing (e.g. luggage that has been piled too high), the closing procedure is stopped and the trunk reopens slightly.



To prevent a possible inadvertent lock-out, the trunk will open automatically if a SmartKey with KEYLESS-GO is recognized inside the vehicle or in the trunk.

Warning!

Monitor the closing procedure carefully to ensure that no one is in danger of being injured. To prevent possible personal injury, always keep hands and fingers away from the trunk opening when closing the trunk. Be especially careful when small children are around. To stop the closing procedure, do one of the following:

- press KEYLESS-GO locking/closing switch ①
- press trunk closing switch
- press the  button on the SmartKey with KEYLESS-GO
- press the remote trunk opening or closing switch (on driver's door)

Even with the SmartKey with KEYLESS-GO removed from the vehicle, the trunk closing switch can be operated. Therefore, do not leave children unattended in the vehicle, or with access to an unlocked vehicle. Unsupervised use of vehicle equipment may cause an accident and/or serious personal injury.

Warning!

Only drive with the trunk closed as, among other dangers such as blocked visibility, exhaust fumes may enter the vehicle interior.

Trunk emergency release

With the emergency release button, the trunk can be opened from inside the trunk.

The emergency release button is located on the inside of the trunk lid.



① Emergency release button

- ▶ Briefly press emergency release button ①.

The trunk unlocks and opens slightly.

- ▶ Push up the trunk lid to fully open.

Locking and unlocking



The emergency release button unlocks and opens the trunk while the vehicle is standing still or in motion.

Illumination of the emergency release button:

- The button will flash for 30 minutes after opening the trunk.
- The button will flash for 60 minutes after closing the trunk.



The emergency release button does not open the trunk if the vehicle battery is discharged or disconnected.





If the trunk does not open, it is still locked separately (▷ page 116).



If the vehicle has previously been locked using the SmartKey or KEYLESS-GO*, opening the trunk from the inside using the emergency release button will trigger the anti-theft alarm system.

To cancel the alarm, do one of the following:

- Insert the SmartKey in the starter switch.
- Press button  or  on the SmartKey.

In vehicles with KEYLESS-GO*:

- Pull an outside door handle.
The SmartKey with KEYLESS-GO* must be within 3 ft (1 m) of the vehicle.
- Press the KEYLESS-GO* start/stop button (▷ page 35).

The SmartKey with KEYLESS-GO* must be inside the vehicle.

Valet locking



To deny any unauthorized person access to the trunk, e.g. when you valet park the vehicle, lock it separately with the mechanical key. Leave only the SmartKey or SmartKey with KEYLESS-GO* less its mechanical key with the vehicle.

The lock is located next to the handle above the rear license plate recess.

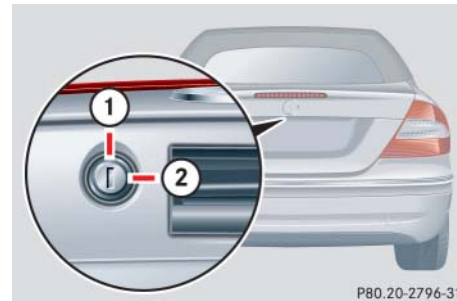

- ① Neutral position
- ② Locked

P80.20-2796-31

- ▶ Close the trunk (▷ page 110).
- ▶ Pull the mechanical key out of the SmartKey (▷ page 419).
- ▶ Insert the mechanical key in the trunk lid lock.
- ▶ Turn the mechanical key clockwise to position ② and remove the mechanical key in that position to lock the trunk.

The trunk remains locked even when the vehicle is centrally unlocked.



You can only cancel the separate trunk locking mode by means of the mechanical key.

- ▶ Insert the mechanical key in the trunk lid lock.
- ▶ Turn the mechanical key counterclockwise to neutral position ① and remove the mechanical key in that position to unlock the trunk.

You can now open the trunk (▷ page 108).

Automatic central locking

The doors and the trunk automatically lock when the ignition is switched on and the wheels are turning at vehicle speeds of approximately 9 mph (15 km/h) or more.

You can open a locked door from the inside. Open door only when conditions are safe to do so.



The doors unlock automatically after an accident if the force of the impact exceeds a preset threshold.

To prevent the vehicle door locks from locking, deactivate the automatic central locking when the vehicle

- is pushed or towed
- is on a test stand

You can deactivate the automatic locking mode using the control system, see “Setting automatic locking” (▷ page 159).

Locking and unlocking

Locking and unlocking from the inside

You can lock or unlock the doors and the trunk from inside using the central locking or unlocking switch. This can be useful, for example, if you want to lock the vehicle before starting to drive.

You cannot lock or unlock the fuel filler flap with the central locking or unlocking switch.

Warning!



When leaving the vehicle, always remove the SmartKey or SmartKey with KEYLESS-GO* from the starter switch, take it with you, and lock the vehicle. Do not leave children unattended in the vehicle, or with access to an unlocked vehicle. Unsupervised use of vehicle equipment may cause an accident and/or serious personal injury.

The switches are located in the center console.



- ① Central locking switch
- ② Central unlocking switch



You can open a locked door from the inside. Open door only when conditions are safe to do so.

If the vehicle was previously centrally locked with the SmartKey or the SmartKey with KEYLESS-GO*, it will not unlock using the central unlocking switch ②.

If the vehicle was previously locked with the central locking switch ①

- while in the selective remote control mode, only the door opened from inside is unlocked.
- while in the global remote control mode, the complete vehicle is unlocked when a door is opened from the inside.

Locking

- ▶ Press central locking switch ①.

If both doors are closed, the vehicle locks.

Unlocking

- ▶ Press central unlocking switch ②.

The vehicle unlocks.

▼ Seats

For information on seat adjustment, see “Adjusting” (▷ page 37).

Front seat active head restraints

Warning!



For your protection, drive only with properly positioned head restraints.

Adjust head restraint so that the center of the head restraint supports the back of the head at eye level. This will reduce the potential for injury to the head and neck in the event of an accident or similar situation.

Do not drive the vehicle without the seat head restraints. Head restraints are intended to help reduce injuries during an accident.

You cannot remove the active head restraints on the driver’s and passenger’s seats.

For removal of the active head restraints we recommend that you contact an authorized Mercedes-Benz Center.



Adjust the head restraint in such a way that it is as close to the head as possible.

For information on head restraint adjustment, see “Seats” (▷ page 37)
For information on active head restraints, see “Active head restraints” (▷ page 73).

Rear seat head restraints

Warning!



For safety reasons, always drive with the rear head restraints in the raised position when the rear seats are occupied.

Keep the area around head restraints clear of articles (e.g. clothing) to not obstruct the lowering/raising operation of the head restraints.

Raising rear head restraints

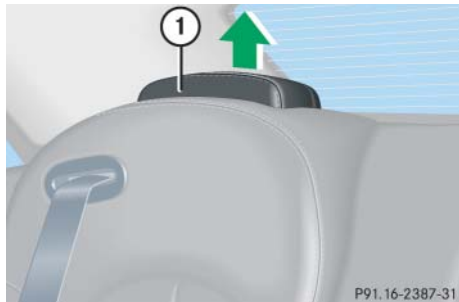

① Rear seat head restraint

- ▶ Pull head restraint ① to its highest position.

Lowering rear head restraints with switch in the center console



① Rear head restraint lowering switch

- ▶ Switch on the ignition (▷ page 34).
- ▶ Push the rear head restraints lowering switch ①.

The rear head restraints are lowered.



The rear head restraints cannot be lowered using the switch ① when the roll bars have been released. The roll bars need to be lowered before the rear head restraints can be operated again using switch ①.

- If the roll bars have released and the soft top is closed, contact an authorized Mercedes-Benz Center to have the roll bars lowered. Do not attempt to lower the roll bars manually with the soft top closed. Lowering the roll bars manually with the soft top closed may impair the function of the roll bars.
- If the roll bars have released and the soft top is open, you can lower the roll bars manually (▷ page 424) or contact an authorized Mercedes-Benz Center to have the roll bars lowered.

Multicontour seat*

The multicontour seat has a movable seat cushion and inflatable air cushions built into the backrest to provide additional lumbar and side support.

The seat cushion movement, backrest cushion height and curvature can be continuously varied with switches on the side of the seat after switching on ignition.

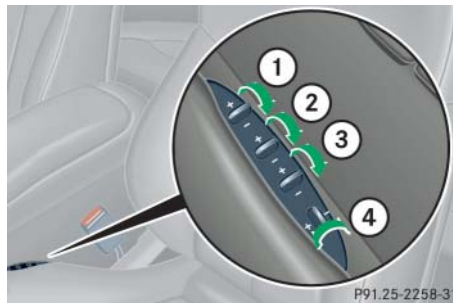

- ① Seat cushion depth
 - ② Backrest bottom
 - ③ Backrest center
 - ④ Side bolster adjustment
- ▶ Switch on the ignition (▷ page 36).

Seat cushion depth

- ▶ Adjust the seat cushion depth to the length of your upper leg using switch ①.

Backrest contour

- ▶ Adjust the contour of the backrest to the desired position using switches ② and ③.

Backrest side bolsters

- ▶ Adjust the backrest side bolsters so that they provide good lateral support using switch ④.

Seats

Seat heating*

Both switches for the front seats are located in the center console.



① Seat heating switch

The red indicator lamps on the switch ① show which heating level you have selected.

Level	
3	Three indicator lamps on (highest level). After approximately five minutes, seat heating is automatically switched to level 2.
2	Two indicator lamps on. After approximately ten minutes, seat heating is automatically switched to level 1.
1	One indicator lamp on (lowest level). After approximately 20 minutes, seat heating is automatically switched off.
off	No indicator lamp on.

- ▶ Switch on the ignition (▷ page 34).

Switching on seat heating

- ▶ Press seat heating switch ① once.
Three red indicator lamps in the switch come on.
- ▶ Continue pressing seat heating switch ① until desired seat heating level is reached.

Switching off seat heating

- ▶ Press seat heating switch ① repeatedly until all red indicator lamps go out.



If one or more of the indicator lamps on the seat heater switch ① are flashing, there is insufficient voltage due to too many electrical consumers being switched on. The seat heating switches off automatically.

The seat heating will switch back on again automatically as soon as sufficient voltage is available.

Seat ventilation*

Both switches for the front seats are located in the center console.



① Seat ventilation switch

The blue indicator lamps in the switch ① show which ventilation level you have selected:

Level	
3	Three indicator lamps on
2	Two indicator lamps on
1	One indicator lamp on
off	No indicator lamp on

- ▶ Switch on the ignition (▷ page 34).

All lamps in the instrument cluster come on.

Switching on seat ventilation

- ▶ Press seat ventilation switch ①.
Three blue indicator lamps come on.
- ▶ Press seat ventilation switch ① repeatedly until the desired seat ventilation level is reached.



The seat ventilation for the driver's seat is automatically set to the highest level if activated via summer opening feature (▷ page 252).

Switching off seat ventilation

- ▶ Press seat ventilation switch ① repeatedly until all blue indicator lamps go out.



If one or more of the indicator lamps on the seat ventilation switch ① are flashing, there is insufficient voltage due to too many electrical consumers being switched on. The seat ventilation switches off automatically.

The seat ventilation will switch back on again automatically as soon as sufficient voltage is available.

Memory function

Prior to operating the vehicle, the driver should check and adjust the seat height, seat position fore and aft, and seat backrest angle if necessary, to ensure adequate control, reach and comfort. The head restraint should also be adjusted for proper height. See also the section on air bags (▷ page 63) for proper seat positioning.

In addition, adjust the steering wheel to ensure adequate control, reach, operation and comfort. Both the interior and exterior rear view mirrors should be adjusted for adequate rear vision.

Fasten seat belts. Infants and small children should be seated in a properly secured restraint system that complies with U.S. Federal Motor Vehicle Safety Standards 213 and 225 and Canadian Motor Vehicle Safety Standards 213 and 210.2.

The following settings are stored when using the buttons on the driver's door:

- Driver's seat, backrest and head restraint position
- Steering wheel position
- Exterior rear view mirror position

Warning!



Do not activate the memory function while driving. Activating the memory function while driving could cause the driver to lose control of the vehicle.

The following settings are stored when using the buttons on the passenger door:

- Front passenger seat, backrest and head restraint position

The memory button and memory position switch are located on the door.

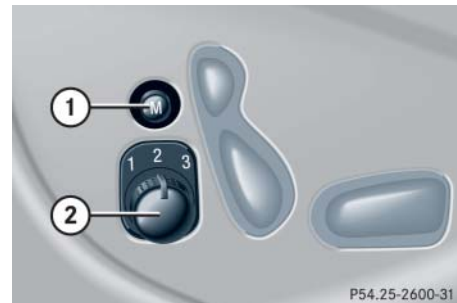

- ① Memory button
- ② Memory position switch

► Switch on the ignition (▷ page 34).

or

► Open the respective door and insert the SmartKey in the starter switch.

Storing positions into memory

- ▶ Adjust the seats, steering wheel and exterior rear view mirrors to the desired position (▷ page 37).
- ▶ Turn memory position switch ② to the desired memory position.
- ▶ Press memory button ①.
- ▶ Release memory button ① and press memory position switch ② within three seconds.

All settings are stored to the selected position.

Recalling positions from memory



Do not operate the seats using the memory button if the seat backrest is in an excessively reclined position. Doing so could cause damage to front or rear seats.

First move the seat backrest to an upright position.

- ▶ Turn memory position switch ② to the desired memory position.
- ▶ Press and hold memory position switch ② until the seat, steering wheel and exterior rear view mirrors have completely moved to the stored positions.



Releasing the memory position switch stops movement to the stored positions immediately.

Memory function

Storing exterior rear view mirror parking position

For easier parking, you can adjust the passenger-side exterior rear view mirror so that you can see the right rear wheel as soon as you engage reverse gear **R**.

For information on activating the parking position feature, see “Setting parking position for exterior rear view mirror”

(▷ page 161) and “Activating exterior rear view mirror parking position” (▷ page 183).

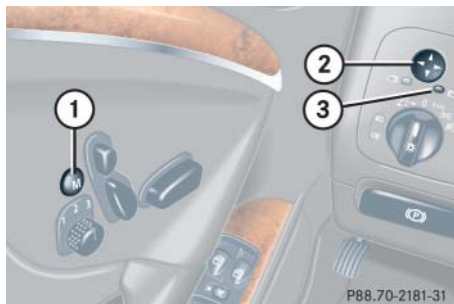

- ① Memory button
- ② Adjustment button
- ③ Passenger side exterior rear view mirror button

- ▶ Stop the vehicle.
- ▶ Switch on the ignition (▷ page 34).
- ▶ Press button ③.

The passenger-side exterior rear view mirror is selected.

- ▶ Adjust the passenger-side exterior rear view mirror with button ② so that you see the rear wheel and the road curb.
- ▶ Press memory button ①.
- ▶ Within three seconds, press bottom of adjustment button ②.

The parking position is stored if the mirror does not move.



If the mirror does move, repeat the above steps. After the setting is stored you can move the mirror again.

▼ Lighting

For information on how to switch on the headlamps and use the turn signals, see “Switching on headlamps” (▷ page 52) and “Turn signals” (▷ page 53).



If you drive in countries where vehicles drive on the other side of the road than the country in which the vehicle is registered, you must have the headlamps modified for symmetrical low beams. Relevant information can be obtained at an authorized Mercedes-Benz Center.



Vehicles equipped with active Bi-Xenon* headlamps: The active Bi-Xenon headlamps monitor your steering angle and driving speed, then automatically shift their beams to either side to better follow the curvature of the road ahead, increasing usable illumination over conventional headlamps.

Exterior lamp switch

The exterior lamp switch is located on the dashboard to the left of the steering wheel.



Exterior lamp switch

- 0** Off
Daytime running lamp mode (▷ page 129)
- AUTO** Automatic headlamp mode
Daytime running lamp mode (▷ page 129)
- ▷DRL** Parking lamps (also tail lamps, license plate lamps, side marker lamps, instrument panel lamps)
- ☰D** Low beam headlamps (or high beam headlamps when the combination switch is pushed forward) and parking lamps
- P<->** Standing lamps, right (turn left one stop)
- <-P** Standing lamps, left (turn left two stops)
- F&O** Indicator lamp for front fog lamps
- 0#&** Indicator lamp for rear fog lamp

Lighting



With the SmartKey removed from the starter switch or the engine turned off with KEYLESS-GO* and the driver's door open, a warning sounds if the parking lamps or low beam headlamps are switched on.

The message **Turn off lamps** appears in the multifunction display.

Manual headlamp mode

The low beam headlamps and the parking lamps can be switched on and off with the exterior lamp switch.

Automatic headlamp mode

The following lamps switch on and off automatically depending on the brightness of the ambient light:

- Low beam headlamps
- Tail and parking lamps
- License plate lamps
- Side marker lamps



Warning!



If the exterior lamp switch is set to **AUTO**,

- the headlamps may switch off unexpectedly when the system senses bright ambient light, for example light from oncoming traffic.
- the headlamps will not be automatically switched on under foggy conditions.

To minimize risk to you and to others, activate headlamps by turning exterior lamp switch to  when driving or when traffic and/or ambient lighting conditions require you to do so.

In low ambient lighting conditions, only switch from position **AUTO** to  with the vehicle at a standstill in a safe location. Switching from **AUTO** to  will briefly switch off the headlamps. Doing so while driving in low ambient lighting conditions may result in an accident.

The automatic headlamp feature is only an aid to the driver. The driver is responsible for the operation of the vehicle's lights at all times.

- ▶ Turn the exterior lamp switch to position **AUTO**.

With the SmartKey in starter switch position **1** or the KEYLESS-GO* start/stop button pressed once, only the parking lamps will switch on and off automatically.

When the engine is running, the low beam headlamps, the tail and parking lamps, the license plate lamps, and the side marker lamps will switch on and off automatically.

Daytime running lamp mode

- ▶ Turn the exterior lamp switch to position **0** or **AUTO**.

When the engine is running, the low beam headlamps are switched on.

In low ambient light conditions, the following lamps will switch on additionally:

- Tail and parking lamps
- License plate lamps
- Side marker lamps

For nighttime driving you should turn the exterior lamp switch to position  to permit activation of the high beam headlamps.



With the daytime running lamp mode activated and the exterior lamp switch in position **0**, the high beam headlamps cannot be switched on.



The high beam flasher is available at all times.

Canada only

The daytime running lamp mode is mandatory and therefore in a constant mode.

When the engine is running, and you shift from a driving position to position **N** or **P**, the low beam headlamps will switch off with a three-minute delay.



When the engine is running, and you

- turn the exterior lamp switch to position , the parking lamps switch on additionally.
- turn the exterior lamp switch to position , the manual headlamp mode has priority over the daytime running lamp mode.

The corresponding exterior lamps switch on (▷ page 127).

USA only

By default, the daytime running lamp mode is deactivated. Activate the daytime running lamp mode using the control system, see “Setting daytime running lamp mode (USA only)” (▷ page 156).

When the engine is running, and you turn the exterior lamp switch to position  or , the manual headlamp mode has priority over the daytime running lamp mode.

The corresponding exterior lamps switch on (▷ page 127).

Locator lighting and night security illumination



The locator lighting and the night security illumination are described in the “Control system” section, see “Setting locator lighting” (▷ page 157) and “Setting night security illumination” (▷ page 158).

Lighting

Fog lamps

Warning!



In low ambient lighting or foggy conditions, only switch from position **AUTO** to  with the vehicle at a standstill in a safe location. Switching from **AUTO** to  will briefly switch off the headlamps. Doing so while driving in low ambient lighting conditions may result in an accident.



Fog lamps will operate with the parking lamps and/or the low beam headlamps on. Fog lamps should only be used in conjunction with low beam headlamps. Consult your State or Province Motor Vehicle Regulations regarding permissible lamp operation.



Fog lamps cannot be switched on with the exterior lamp switch in position **AUTO**. For switching on the fog lamps, turn the exterior lamp switch to position  first.



Front fog lamps

- ▶ Switch on the low beam headlamps (▷ page 52).
- ▶ Pull out the exterior lamp switch to first stop.

The front fog lamps switch on.



The green indicator lamp  in the exterior lamp switch comes on (▷ page 127).

- ▶ Push in the exterior lamp switch.

The front fog lamps switch off.

The green indicator lamp  in the exterior lamp switch goes out.

Rear fog lamp (driver's side only)

- ▶ Switch on the front fog lamps (▷ page 130).
- ▶ Pull out the exterior lamp switch to second stop.
The rear fog lamp is switched on.
The yellow indicator lamp  in the exterior lamp switch comes on (▷ page 127).
- ▶ Push in the exterior lamp switch to first stop.
The rear fog lamp switches off.
The yellow indicator lamp  in the exterior lamp switch goes out.
The front fog lamps remain lit.

Combination switch

The combination switch is located on the left of the steering column.

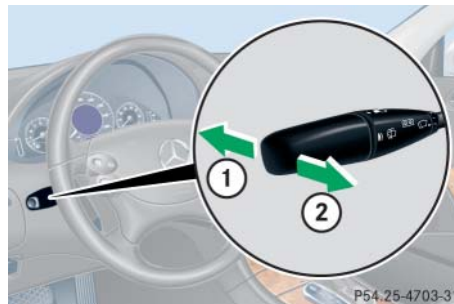

Combination switch

- ① High beam
- ② High beam flasher

High beam

- ▶ Turn the exterior lamp switch to position  or **AUTO** (▷ page 127).
- ▶ Push the combination switch in direction of arrow ① to switch on the high beam.

The high beam headlamp indicator lamp  in the instrument cluster comes on (▷ page 24).

- ▶ Pull the combination switch in direction of arrow ② to its original position to switch off the high beam.

The high beam headlamp indicator lamp  in the instrument cluster goes out.

High beam flasher

- ▶ Pull the combination switch briefly in direction of arrow ②.

Lighting

Corner-illuminating front fog lamps* (CLK with Bi-Xenon* headlamps)

The corner-illuminating front fog lamps improve illumination of the road into which you are turning.

The corner-illuminating front fog lamps will operate with the engine running and with

- the exterior lamp switch in position  (▷ page 127)
or
- the exterior lamp switch in position **AUTO** (▷ page 127)
or
- the daytime running lamp mode activated (▷ page 129)



Corner-illuminating front fog lamps will only come on in low ambient lighting conditions.

The corner-illuminating front fog lamps function is not available at a vehicle speed above 25 mph (40 km/h).

Driving forward

Switching on corner-illuminating front fog lamps

- ▶ Depending on whether you are turning left or right, switch on the left or right turn signal (▷ page 53).

The respective front fog lamp comes on and illuminates the road onto which you are turning.



The corner-illuminating front fog lamps will come on automatically depending on the steering angle, even if you did not switch on either turn signal. If the corner-illuminating front fog lamps came on automatically, they will also go out automatically depending on the steering angle.

Switching off corner-illuminating front fog lamps

The combination switch for the turn signal resets automatically after major steering wheel movements. This will switch off the corner-illuminating front fog lamps if they were activated by switching on the left or right turn signal.

If the turn signal should stay on after making the turn, the turn signal and corner-illuminating front fog lamps can be switched off by returning the combination switch to its original position.

Driving rearward

Switching on corner-illuminating front fog lamps

- ▶ Place the gear selector lever in position **R**.

The inverse front fog lamp comes on automatically depending on the steering direction and steering angle.

Switching off corner-illuminating front fog lamps

- ▶ Place the gear selector lever out of position **R**.

The respective front fog lamp goes out.

Hazard warning flasher

The hazard warning flasher can be switched on at all times, even with the SmartKey or the SmartKey with KELESS-GO* removed from the starter switch or with the SmartKey with KEYLESS-GO* removed from the vehicle.

The hazard warning flasher switches on automatically when an air bag deploys.

The hazard warning flasher switch is located on the upper part of the center console.



① Hazard warning flasher switch

Switching on hazard warning flasher

- ▶ Press hazard warning flasher switch ①.

All turn signals are flashing.



With the hazard warning flasher activated and the combination switch set for either left or right turn, only the respective turn signals will operate when the ignition is switched on.

Switching off hazard warning flasher

- ▶ Press hazard warning flasher switch ① again.



If the hazard warning flasher has been activated automatically, press hazard warning flasher switch ① once to switch it off.

Lighting

Interior lighting

The controls are located in the overhead control panel.



- ① Left front reading lamp
- ② Rocker switch for automatic control system
- ③ Right front reading lamp

Activating automatic control

- ▶ Press the rocker switch ② to the center position.

Interior lamps are switched on in darkness when you:

- unlock the vehicle
- open a door
- remove the SmartKey from the starter switch

The interior lamps are switched off after a preset time, see “Setting interior lighting delayed shut-off” (▶ page 159).



If the door remains open, the interior lamps switch off automatically after approximately five minutes when the SmartKey is removed or in starter switch position **0**.

An interior lamp switched on manually does not go out automatically.

Deactivating automatic control

- ▶ Press the  symbol on rocker switch ②.

The interior lighting remains switched off in darkness, even when you:

- unlock the vehicle
- open a door
- remove the SmartKey from the starter switch



The trunk lamp switches on if the trunk is opened.

If you leave the trunk open for an extended period of time, the trunk lamp will switch off automatically after approximately ten minutes.

Manual control

Switching all front interior lights on and off

- ▶ Press the  symbol on rocker switch ②.

The front interior lights come on.

- ▶ Press rocker switch ② to center position to activate the automatic control.

Switching right front reading lamp on and off

- ▶ Press right button .

The right reading lamp comes on.

- ▶ Press right button  again.

The right reading lamp goes out.

Switching left front reading lamp on and off

- ▶ Press left button .

The left reading lamp comes on.

- ▶ Press left button  again.

The left reading lamp goes out.

Door entry lamps

The appropriate door entry lamp switches on if a door is opened in darkness and if the interior lighting is switched to automatic function.

The entry lamp switches off automatically when the door is closed.



If you turn the SmartKey in the starter switch to position **0** and switch off the exterior headlamps, the door entry lamps will remain lit for approximately five minutes.

Trunk lamp

The trunk lamp switches on if the trunk is opened.

If you leave the trunk open for an extended period of time, the trunk lamp will switch off automatically after approximately ten minutes.

Instrument cluster

For a full view illustration of the instrument cluster, see “Instrument cluster” (▷ page 24).

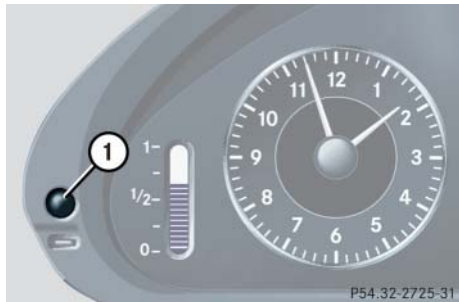

① Reset button

The instrument cluster is activated when you

- open a door
- switch on the ignition (▷ page 36)
- press reset button ①
- switch on the exterior lamps

You can change the instrument cluster settings in the Instrument cluster submenu of the control system (▷ page 151).

Instrument cluster illumination

Use the reset button ① to adjust the illumination brightness for the instrument cluster.



The instrument cluster illumination is dimmed or brightened automatically to suit ambient light conditions.

The instrument cluster illumination will also be adjusted automatically when you switch on the vehicle's exterior lamps.

To brighten illumination

- ▶ Turn reset button ① clockwise.
The instrument cluster illumination will brighten.

To dim illumination

- ▶ Turn reset button ① counterclockwise.
The instrument cluster illumination will dim.

Coolant temperature indicator

The coolant temperature indicator is on the right side in the instrument cluster (▷ page 24).

Warning!



- Driving when your engine is badly overheated can cause some fluids which may have leaked into the engine compartment to catch fire. You could be seriously burned.
- Steam from an overheated engine can cause serious burns and can occur just by opening the hood. Stay away from the engine if you see or hear steam coming from it.

Turn off the engine, get out of the vehicle and do not stand near the vehicle until the engine has cooled down.



Excessive coolant temperature triggers a warning in the multifunction display (▷ page 398) and the red coolant warning lamp in the instrument cluster comes on (▷ page 377).

During severe operating conditions, e.g. stop-and-go traffic, the coolant temperature may rise close to 120°C.

The engine should not be operated with the coolant temperature above 120°C. Doing so may cause serious engine damage which is not covered by the Mercedes-Benz Limited Warranty.

Trip odometer

- ▶ Make sure you are viewing the standard display in the multifunction display (▷ page 144).
- ▶ If it is not displayed, press button or on the multifunction steering wheel repeatedly until the standard display appears (▷ page 140).
- ▶ Press and hold the reset button on the instrument cluster (▷ page 136) until the trip odometer is reset.

Tachometer

The red marking on the tachometer (▷ page 24) denotes excessive engine speed.



Avoid driving at excessive engine speeds, as it may result in serious engine damage that is not covered by the Mercedes-Benz Limited Warranty.

To help protect the engine, the fuel supply is interrupted if the engine is operated within the red marking.

Outside temperature indicator

Warning!



The outside temperature indicator is not designed to serve as an ice-warning device and is therefore unsuitable for that purpose.

Indicated temperatures just above the freezing point do not guarantee that the road surface is free of ice. The road may still be icy, especially in wooded areas or on bridges.

The outside temperature is indicated in the multifunction display (▷ page 140).

The temperature sensor is located in the front bumper area. Due to its location, the sensor can be affected by road or engine heat during idling or slow driving. This means that the accuracy of the displayed temperature can only be verified by comparison to a thermometer placed next to the sensor, not by comparison to external displays (e.g. bank signs etc.).

When moving the vehicle into colder ambient temperatures (e.g. when leaving your garage), you will notice a delay before the lower temperature is displayed.

A delay also occurs when ambient temperatures rise. This prevents inaccurate temperature indications caused by heat radiated from the engine during idling or slow driving.

▼ Control system

The control system is activated as soon as the SmartKey in the starter switch is turned to position **1** or as soon as the KEYLESS-GO* start/stop button is in position **1**. The control system enables you to

- call up information about your vehicle
- change vehicle settings

For example, you can use the control system to find out when your vehicle is next due for service, to set the language for messages in the instrument cluster display, and much more.



The displays for the audio systems (radio, CD player etc.) will appear in English, regardless of the language selected.

Warning!



A driver's attention to the road and traffic conditions must always be his /her primary focus when driving.

For your safety and the safety of others, selecting features through the multifunction steering wheel should only be done by the driver when traffic and road conditions permit it to be done safely.

Bear in mind that at a speed of just 30 mph (approximately 50 km/h), your vehicle is covering a distance of 44 feet (approximately 14 m) every second.

The control system relays information to the multifunction display.

Control system

Multifunction display



- ① Outside temperature
- ② Trip odometer
- ③ Current shift program mode
- ④ Main odometer
- ⑤ Current gear selector lever position/gear range

For more information on menus displayed in the multifunction display, see “Menus” (▷ page 142).

Multifunction steering wheel

The displays in the multifunction display and the settings in the control system are controlled by the buttons on the multifunction steering wheel (▷ page 26).

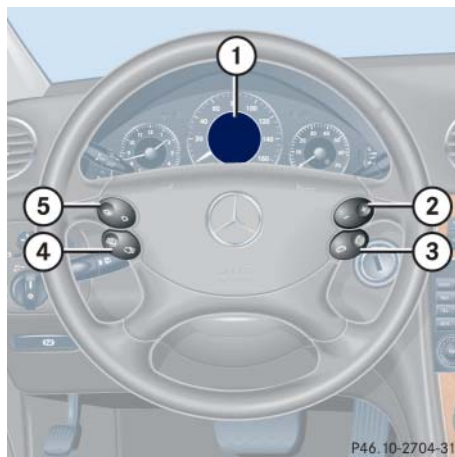





- ① Multifunction display
- Operating the control system**
- ② Selecting the submenu or setting the volume:
Press button
 up / to increase
 down / to decrease
 - ③ Telephone*:
Press button
 to take a call
 to end a call
 - ④ Menu systems:
Press button
 for next menu
 for previous menu
 - ⑤ Moving within a menu
Press button
 for next display
 for previous display

Pressing any of the buttons on the multifunction steering wheel will alter what is shown in the multifunction display.

The information available in the multifunction display is arranged in menus, each containing a number of functions or submenus.

The individual functions are then found within the relevant menu (radio or CD operations under *Audio*, for example). These functions serve to call up relevant information or to customize the settings for your vehicle.

It is helpful to think of the menus, and the functions within each menu, as being arranged in a circular pattern.

- If you press button  or  repeatedly, you will pass through each menu one after the other.
- If you press button  or  repeatedly, you will pass through each function display, one after the other, in the current menu.

In the *Settings* menu, instead of functions you will find a number of submenus for calling up and changing settings. For instructions on using these submenus, see “Submenus in the Settings menu” (▷ page 149).

The number of menus available in the system depends on which optional equipment is installed in your vehicle.

The menus are described on the following pages.

Control system

Menus

This is what you will see when you scroll through the menus.

The table on the next page provides an overview of the individual menus.

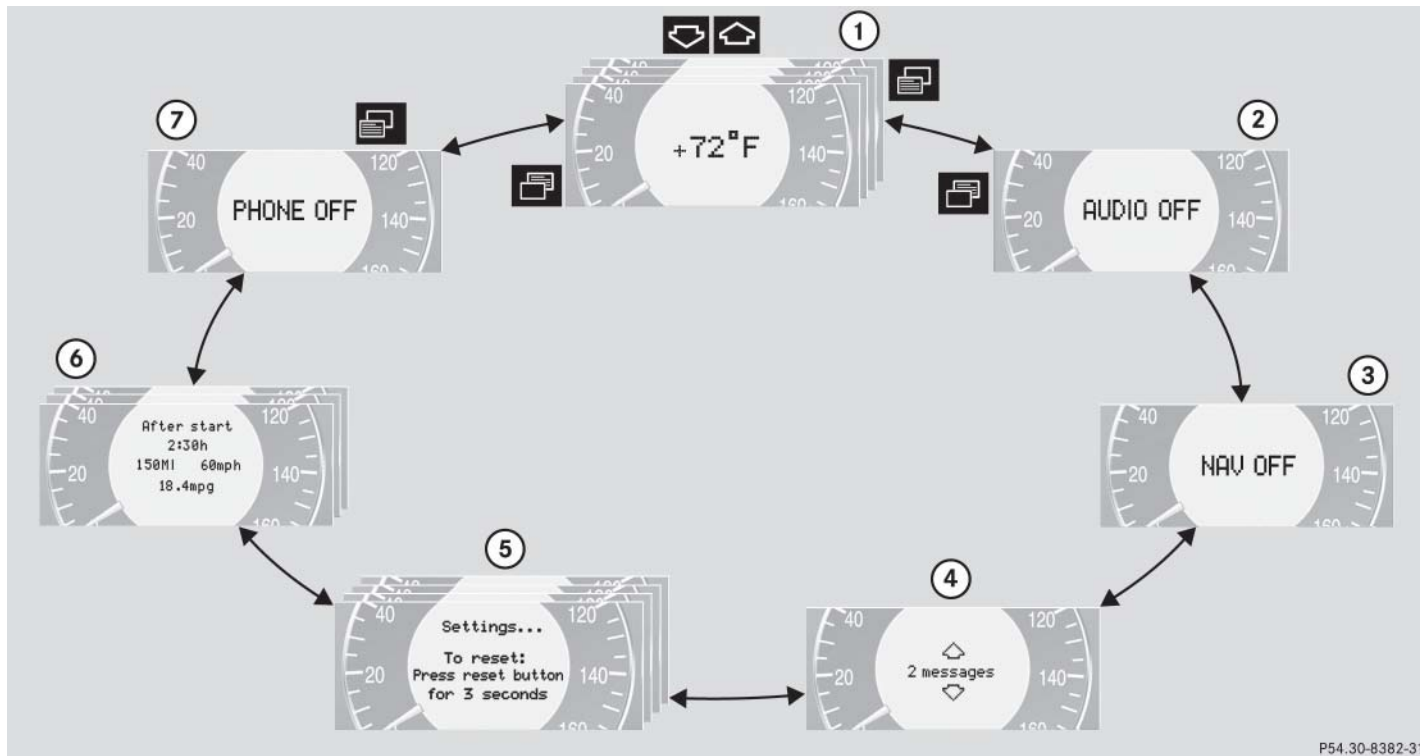

P54.30-8382-31

Menus, submenus and functions

	Menu ①	Menu ②	Menu ③	Menu ④	Menu ⑤	Menu ⑥	Menu ⑦
	Standard display	AUDIO	NAV*	Vehicle status message memory¹	Settings	Trip computer	Telephone*
	(▷ page 144)	(▷ page 145)	(▷ page 146)	(▷ page 146)	(▷ page 148)	(▷ page 161)	(▷ page 163)
Commands/submenus	Run Flat Indicator*	Select radio station	Show route guidance instructions, current direction traveled	Calling up vehicle malfunction, warning and system status messages stored in memory	Reset to factory settings	Fuel consumption statistics after start	Load phone book
	Digital speedometer	Select satellite radio station* (USA only)			Instrument cluster submenu	Fuel consumption statistics since the last reset	Search for name in phone book
	Call up maintenance service display	Operate CD player			Time/Date submenu	Call up range	
	Check engine oil level (except CLK 350)				Lighting submenu Vehicle submenu Convenience submenu		

¹ The vehicle status message memory menu is only displayed if there is a message stored.

Control system



The headings used in the menus table are designed to facilitate navigation within the system and are not necessarily identical to those shown in the control system displays.

The first function displayed in each menu will automatically show you which part of the system you are in.

Standard display menu

In the standard display, the outside temperature and the trip odometer are shown in the multifunction display.



You can have the digital speedometer displayed instead of the outside temperature in the standard display. You can select the setting in the submenu Instr. cluster via the function Basic display (> page 152).



- ① Outside temperature
- ② Trip odometer

If you see another display, press button or repeatedly until the standard display appears.

- ▶ Press button or to select the functions in the standard display menu.

The following functions are available:

Function	Page
Run Flat Indicator	342
Call up digital speedometer	144
Call up maintenance service display	362
Check engine oil level	323

Display digital speedometer

- ▶ Press button or until the digital speedometer appears in the multifunction display.

The current vehicle speed is shown in the multifunction display and the status line appears.



- ① Digital Speedometer
- ② Status line with outside temperature
- ③ Trip odometer



You can have the digital speedometer displayed instead of the outside temperature in the status line. You can select the setting in the submenu Instr. cluster via the function Status line display (> page 152).

AUDIO menu



The functions in the **Audio** menu operate the audio equipment which you currently have turned on.

If no audio equipment is currently turned on, the message **Audio off** is shown in the multifunction display.

The following functions are available:

Function	Page
Select radio station	145
Select satellite radio station* (USA only)	145
Operate CD player	146

Select radio station

- ▶ Turn on the radio (▷ page 212) and select radio. Vehicles with **COMAND***: Refer to separate operating instructions.
- ▶ Press button  or  repeatedly until the currently tuned station appears in the multifunction display.



- ① Waveband setting
- ② Station frequency

- ▶ Press button  or  repeatedly until the desired station is found.



You can only store new stations using the corresponding feature on the radio (▷ page 219).

Vehicles with **COMAND***: Refer to separate operating instructions.

You can also operate the radio in the usual manner.



Select satellite radio station* (USA only)

The satellite radio is treated as a radio application.

- ▶ Select satellite radio with the corresponding soft key (**SAT**) in the radio menu.



- ① SAT mode and preset number
- ② Setting for station selection using memory
- ③ Channel name or number

- ▶ Press button  or  repeatedly until the desired channel is found.

Control system



For more information on satellite radio operation, see “Introduction to satellite radio* (USA only)” (> page 222).

Vehicles with COMAND*: Refer to separate operating instructions.

Operate the CD player

- ▶ Turn on the radio and select CD (> page 227). Vehicles with COMAND*: Refer to separate operating instructions.
- ▶ Press button or repeatedly until the settings for the CD currently being played appear in the multifunction display.

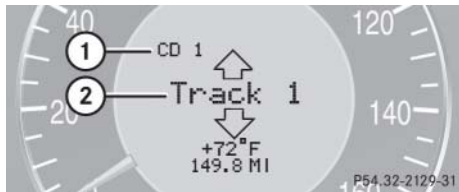

- ① Current CD (for CD changer*)
- ② Current track

- ▶ Press button or repeatedly until the desired track is selected.



To select a CD from the magazine, press a number on the audio system or the COMAND* system key pad located in the center dashboard.

NAV* menu

The Nav menu contains the functions needed to operate your navigation system.

- ▶ Press button or repeatedly until the message Nav appears in the multifunction display.
- If COMAND* is switched off, the message Nav off appears in the multifunction display.
- With COMAND* switched on but route guidance not activated, the direction of travel and, if available, the name of the street currently traveled on appear in the multifunction display.

- With COMAND* switched on and route guidance activated, the direction of travel and maneuver instructions appear in the multifunction display.

Please refer to the COMAND* manual for instructions on how to activate the route guidance system*.



Vehicle status message memory menu

Use the vehicle status message memory menu to scan malfunction and warning messages that may be stored in the system. Such messages appear in the multifunction display and are based on conditions or system status the vehicle's system has recorded.

The vehicle status message memory menu only appears if there are any messages stored.

Warning!

Malfunction and warning messages are only indicated for certain systems and are intentionally not very detailed. The malfunction and warning messages are simply a reminder with respect to the operation of certain systems and do not replace the owner's and/or driver's responsibility to maintain the vehicle's operating safety by having all required maintenance and safety checks performed on the vehicle and by bringing the vehicle to an authorized Mercedes-Benz Center to address the malfunction and warning messages (▷ page 383).

- ▶ Press button  or  repeatedly until the vehicle status message memory appears in the multifunction display.

If the vehicle status message memory does not appear, then there are no messages stored.

Vehicle status messages have been recorded

If conditions have occurred causing status messages to be recorded, the number of messages appears in the multifunction display:



- ① Number of messages

- ▶ Press button  or .

The stored messages will now be displayed in the order in which they have occurred.

For malfunction and warning messages, see “Vehicle status messages in the multifunction display” (▷ page 383).



Should the vehicle's system record any conditions while driving, the number of messages will reappear in the multifunction display when the SmartKey in the starter switch is turned to position **0** or removed from the starter switch. With KEYLESS-GO*, turn off the engine by pressing the KEYLESS-GO* start/stop button and open the driver's door.



The vehicle status message memory will be cleared when you switch on the ignition(▷ page 34). You will then only see high-priority messages in the multifunction display (▷ page 383).

Settings menu

In the Settings menu there are two functions:

- The function **Reset to factory settings?**, with which you can reset all the settings to the original factory settings.
 - A collection of submenus with which you can make individual settings for your vehicle.
- ▶ Press button  or  repeatedly until the Settings menu appears in the multifunction display.



Resetting all settings

You can reset all the functions of all submenus to the factory settings.

- ▶ Press the reset button in the instrument cluster (▷ page 136) for approximately three seconds.

The request to press the reset button once more to confirm appears in the multifunction display.



- ▶ Press the reset button once more.

The functions of all the submenus will reset to factory settings.



The settings you have changed will not be reset unless you confirm the action by pressing the reset button a second time. After approximately five seconds, the Settings... menu reappears in the multifunction display.

For safety reasons, the following function is not reset while driving:

- the **Lamp circuit headlamp function** in the Lighting submenu

Submenus in the Settings menu



- ▶ Press button .



The collection of the submenus appears in the multifunction display.





- ▶ Press button .

The selection marker moves to the next submenu.

The submenus are arranged by hierarchy. Scroll down with button , scroll up with button .

With the selection marker on the desired submenu, use button  to access the individual functions within that submenu. Once within the submenu, you can use button  to move to the next function or button  to move to the previous function within that submenu.

The settings themselves are made with button  or .

Resetting the functions of a submenu

For each submenu you can reset all the functions to the factory settings.

- ▶ Move to a function in the submenu.
- ▶ Press the reset button (\triangleright page 136) in the instrument cluster for approximately three seconds.

The request to press the reset button once more to confirm appears in the multifunction display.

- ▶ Press the reset button once more.

All functions of the submenu will reset to factory settings.



The settings you have changed will not be reset unless you confirm the action by pressing the reset button a second time. After approximately five seconds, the Settings menu reappears in the multifunction display.

Control system

The table below shows what settings can be changed within the various menus.

Detailed instructions on making individual settings can be found on the following pages.

INSTRUMENT CLUSTER	TIME/DATE	LIGHTING	VEHICLE	CONVENIENCE
Selecting speedometer display mode	Setting time (hours)	Setting daytime running lamp mode (USA only)	Setting automatic locking	Activate easy-entry/exit feature
Selecting language	Setting time (minutes)	Setting locator lighting		Setting parking position for exterior rear view mirror
Selecting display (speed display or outside temperature) for the status line	Setting the date (month)	Exterior lamps delayed shut-off		
Selecting display (speed display or outside temperature) for standard display	Setting the date (day)	Interior lighting delayed shut-off		
	Setting the date (year)			

Instrument cluster submenu

Access the Instr. cluster submenu via the Settings menu. Use the Instr. cluster submenu to change the instrument cluster display settings.

The following functions are available:

Function	Page
Selecting speedometer display mode	151
Selecting language	151
Selecting display (speed display or outside temperature) for the status line	152
Selecting display (speed display or outside temperature) for standard display	152

Selecting speedometer display mode

- ▶ Move the selection marker with button **+** or **-** to the Instr. cluster submenu.
- ▶ Press button **↶** or **↷** repeatedly until the message **Display unit Speed-/odometer** appears in the multifunction display.

The selection marker is on the current setting.



- ▶ Press button **+** or **-** to set speedometer unit to km or miles.

Selecting language

- ▶ Move the selection marker with button **+** or **-** to the Instr. cluster submenu.
- ▶ Press button **↶** or **↷** repeatedly until the message **Language** appears in the multifunction display.

The selection marker is on the current setting.



Control system

- ▷▷ Press button **+** or **-** to select the language to be used for the multifunction display messages.

Available languages:

- German (Deutsch)
- English (English)
- French (français)
- Italian (italiano)
- Spanish (Español)
- Dutch (Nederlands)
- Danish (Dansk)
- Swedish (Svenska)
- Portuguese (Português)
- Turkish (Türkçe)

Selecting display (speed display or outside temperature) for the status line

- ▶ Move the selection marker with button **+** or **-** to the Instr. cluster submenu.
- ▶ Press button **↕** or **↕** repeatedly until the message Status line display appears in the multifunction display.

The selection marker is on the current setting.

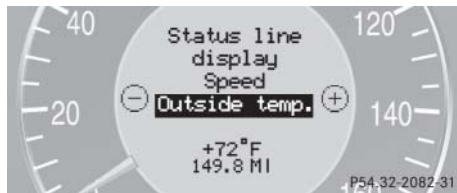

- ▶ Press button **+** or **-** to select the desired setting.



You will see the status line when you have called up a different display from the standard display.

Selecting display (speed display or outside temperature) for standard display

- ▶ Move the selection marker with button **+** or **-** to the Instr. cluster submenu.
- ▶ Press button **↕** or **↕** repeatedly until the message Basic display appears in the multifunction display.

The selection marker is on the current setting.



- ▶ Press button **+** or **-** to select the display mode shown in the basic display.

Time/Date submenu

Access the Time/Date submenu via the Settings menu. Use the Time/Date submenu to change the instrument cluster display settings.

The following functions are available:

Function	Page
Setting the time (hours)	153
Setting the time (minutes)	154
Setting the date (month)	154
Setting the date (day)	155
Setting the date (year)	155

Setting time (hours)

This function can only be seen in vehicles with audio system.



Vehicles with COMAND*:

For information on setting the time in COMAND, refer to the separate COMAND operating instructions.

- ▶ Move the selection marker with button **+** or **-** to the Time/Date submenu.
- ▶ Press button **↶** or **↷** repeatedly until the message **Clock, hours Confirm by press. R** appears in the multifunction display.

The selection marker is on the hour setting.



- ▶ Press button **+** or **-** to set the hour.
- ▶ Press the reset button in the instrument cluster (▷ page 136) to confirm.

The hour is set and stored.

Control system

Setting time (minutes)

This function can only be seen in vehicles with audio system.



Vehicles with COMAND*:

For information on setting the time in COMAND, refer to the separate COMAND operating instructions.

- ▶ Move the selection marker with button **+** or **-** to the Time/Date submenu.
- ▶ Press button **↕** or **↓** repeatedly until the message **Clock, minutes** Confirm by press. R appears in the multifunction display.

The selection marker is on the minutes setting.



- ▶ Press button **+** or **-** to set the minutes.
- ▶ Press the reset button in the instrument cluster (▷ page 136) to confirm. The minutes are set and stored.

Setting the date (month)

This function can only be seen in vehicles with audio system.



Vehicles with COMAND*:

For information on setting the date in COMAND, refer to the separate COMAND operating instructions.

- ▶ Move the selection marker with button **+** or **-** to the Time/Date submenu.

- ▶ Press button **↕** or **↓** repeatedly until the message **Set date month** appears in the multifunction display.

The selection marker is on the month setting.

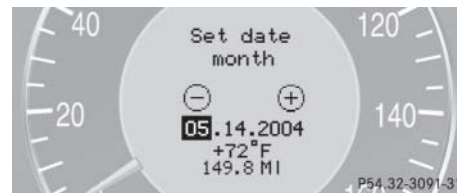

- ▶ Press button **+** or **-** to set the month.

Setting the date (day)

This function can only be seen in vehicles with audio system.



Vehicles with COMAND*:
For information on setting the date in COMAND, refer to the separate COMAND operating instructions.

- ▶ Move the selection marker with button **+** or **-** to the Time/Date submenu.
- ▶ Press button **↶** or **↷** repeatedly until the message Set date day appears in the multifunction display.

The selection marker is on the day setting.



- ▶ Press button **+** or **-** to set the day.

Setting the date (year)

This function can only be seen in vehicles with audio system.



Vehicles with COMAND*:
For information on setting the date in COMAND, refer to the separate COMAND operating instructions.

- ▶ Move the selection marker with button **+** or **-** to the Time/Date submenu.
- ▶ Press button **↶** or **↷** repeatedly until the message Set date year appears in the multifunction display.

The selection marker is on the year setting.



- ▶ Press button **+** or **-** to set the year.

Control system

Lighting submenu

Access the Lighting submenu via the Settings menu. Use the Lighting submenu to change the lamp and lighting settings on your vehicle.

The following functions are available:

Function	Page
Setting daytime running lamp mode (USA only)	156
Setting locator lighting	157
Exterior lamps delayed switch-off	158
Interior lighting delayed switch-off	159

Setting daytime running lamp mode (USA only)



This function is not available in countries where the daytime running lamp mode is mandatory and therefore in a constant mode.

- ▶ Move the selection marker with button **+** or **-** to the Lighting submenu.
- ▶ Press button **↶** or **↷** repeatedly until the message **Lamp circuit headlamp** appears in the multifunction display.

The selection marker is on the current setting.



- ▶ Press button **+** or **-** to select manual operation (**manual**) or daytime running lamp mode (**constant**) activated.

With daytime running lamp mode activated and the exterior lamp switch in position **0** or **AUTO** the low beam headlamps are switched on when the engine is running.

In low ambient light conditions the following lamps will switch on additionally:

- Parking lamps
- Tail lamps
- License plate lamps
- Side marker lamps

For more information on the daytime running lamp mode, see “Lighting” (▷ page 127).



If you turn the exterior lamp switch to another position, the corresponding lamp(s) will switch on.

For safety reasons, resetting the Lighting submenu to factory settings (▷ page 149) while driving will not deactivate the daytime running lamp mode.

The following message appears in the multifunction display:

Lighting - Cannot be completely reset to factory settings while driving.

Setting locator lighting

With the locator lighting feature activated and the exterior lamp switch in position **AUTO**, the following lamps will switch on during darkness when the vehicle is unlocked with the SmartKey:

- Parking lamps
- Tail lamps
- License plate lamps
- Side marker lamps
- Front fog lamps

The locator lighting switches off when the driver’s door is opened.

If you do not open a door after unlocking the vehicle with the SmartKey, the lamps will switch off automatically after approximately 40 seconds.

To activate locator lighting:

- ▶ Make sure the function surround lighting is set to on, see (▷ page 157).

- ▶ Move the selection marker with button **+** or **-** to the Lighting submenu.
- ▶ Press button **↶** or **↷** repeatedly until the message Function Surround lighting appears in the multifunction display.

The selection marker is on the current setting.

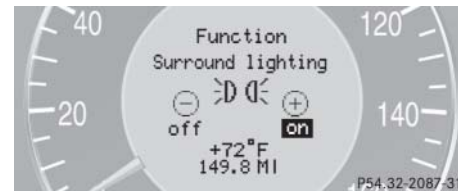

- ▶ Press button **+** or **-** to switch the locator lighting function On.
- ▶ Turn the exterior lamp switch to position **AUTO** when exiting the vehicle (▷ page 127).

The locator lighting feature is activated.

Control system

Setting night security illumination (Headlamps delayed shut-off)

Use this function to set whether you would like the exterior lamps to illuminate during darkness after exiting the vehicle and all doors closed.

With the delayed shut-off feature activated and the exterior lamp switch in position **AUTO** before the engine is turned off, the following lamps will switch on for 15 seconds when the engine is turned off:

- Parking lamps
- Tail lamps
- License plate lamps
- Side marker lamps
- Front fog lamps

If after turning off the engine you do not open a door or do not close an opened door, the lamps will automatically switch off after 60 seconds.



You can reactivate this function within ten minutes by opening a door.

- ▶ Move the selection marker with button **+** or **-** to the Lighting submenu.
- ▶ Press button or repeatedly until the message Headlamps delayed shut-off appears in the multifunction display.

The selection marker is on the current setting.



- ▶ Press button **+** or **-** to switch the headlamps delayed shut-off feature on or off.

- ▶ Turn the exterior lamp switch to position **AUTO** before turning off the engine (▷ page 127).

The headlamps delayed shut-off feature is activated.

You can temporarily deactivate the delayed shut-off feature:

- ▶ Before exiting the vehicle, turn the SmartKey in the starter switch to position **0**.
- ▶ Then turn it to position **2** and back to **0**.

The delayed shut-off feature is deactivated. It will reactivate as soon as you reinsert the SmartKey in the starter switch.

Setting interior lighting delayed shut-off

Use this function to set whether you would like the interior lighting to remain lit during darkness after you have removed the SmartKey from the starter switch. If activated it remains lit for 10 seconds.

- ▶ Move the selection marker with button **+** or **-** to the Lighting submenu.
- ▶ Press button **↶** or **↷** repeatedly until the message Interior lamp delayed shut-off appears in the multifunction display.

The selection marker is on the current setting.



- ▶ Press button **+** or **-** to switch the interior delayed shut-off feature on or off.

Vehicle submenu

Access the Vehicle submenu via the Settings menu. Use the Vehicle submenu to make general vehicle settings.

The following function is available:

Function	Page
Setting automatic locking	159

Setting automatic locking

Use this function to activate or deactivate the automatic central locking. With the automatic central locking system activated, the vehicle is centrally locked at vehicle speeds of approximately 9 mph (15 km/h).

- ▶ Move the selection marker with button **+** or **-** to the Vehicle submenu.
- ▶ Press button **↶** or **↷** repeatedly until the message Automatic door lock appears in the multifunction display.

The selection marker is on the current setting.



- ▶ Press button **+** or **-** to switch the automatic central locking on or off.

Control system

Convenience submenu

Access the Convenience submenu via the Settings menu. Use the Convenience submenu to change the settings for a number of convenience features.

The following functions are available:

Function	Page
Activating easy-entry/exit feature	160
Setting parking position for exterior rear view mirror	161

Activating easy-entry/exit feature

Use this function to activate and deactivate the easy-entry/exit feature (▷ page 42).

Warning!



You must make sure no one can become trapped or injured by the moving steering wheel when the easy-entry/exit feature is activated.

To cancel steering wheel movement, do one of the following:

- Move the steering column stalk (▷ page 41).
- Press the memory position switch (▷ page 124).

Do not leave children unattended in the vehicle, or with access to an unlocked vehicle. Children could open the driver's door and unintentionally activate the easy-entry/exit feature, which could result in an accident and/or serious personal injury.

- ▶ Move the selection marker with button **+** or **-** to the Convenience submenu.
- ▶ Press button **↶** or **↷** repeatedly until the message Function Easy-entry feature appears in the multifunction display. The selection marker is on the current setting.

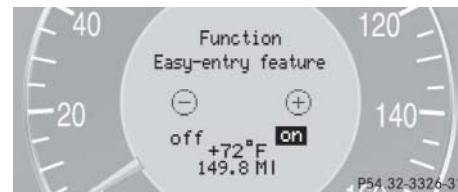

- ▶ Press button **+** or **-** to switch the easy-entry/exit feature on or off.

Setting parking position for exterior rear view mirror

Use the Mirror adjustment parking aid function to select whether the passenger-side exterior rear view mirror should be turned downward during parking maneuvers, when reverse gear **R** is engaged. For additional information, see “Activating exterior rear view mirror parking position” (▷ page 183).

- ▶ Move the selection marker with button **+** or **-** to the Convenience submenu.
- ▶ Press button **↶** or **↷** repeatedly until the message *Mirror adjustment parking aid* appears in the multifunction display.

The selection marker is on the current setting.



- ▶ Press button **+** or **-** to switch function on or off.

Trip computer menu

Use the trip computer menu to call up statistical data on your vehicle.

The following information is available:

Function	Page
Fuel consumption statistics after start	161
Fuel consumption statistics since last reset	162
Call up range (distance to empty)	163

Fuel consumption statistics after start

- ▶ Press button **☰** or **☷** repeatedly until the first function of the trip computer menu appears in the multifunction display.
- ▶ Press button **↶** or **↷** repeatedly until the message *After start* appears in the multifunction display. ▷▷

Control system

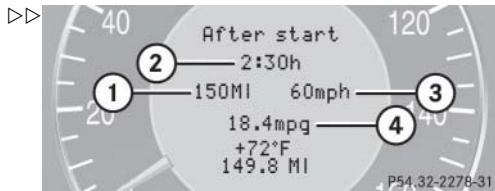

- ① Distance driven since start
- ② Time elapsed since start
- ③ Average speed since start
- ④ Average fuel consumption since start



All statistics stored since the last engine start will be reset approximately four hours after the SmartKey in the starter switch is turned to position **0** or removed from the starter switch.

Resetting will not occur if you turn the SmartKey back to position **1** or **2** within this time period.

Fuel consumption since last reset

- ▶ Press button or repeatedly until the first function of the trip computer menu appears in the multifunction display.
- ▶ Press button or repeatedly until the message **After reset** appears in the multifunction display.

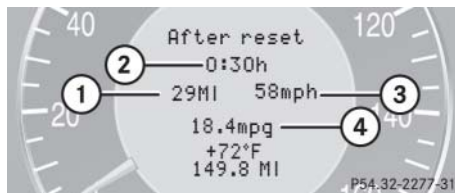





- ① Distance driven since last reset
- ② Time elapsed since last reset
- ③ Average speed since last reset
- ④ Average fuel consumption since last reset

Resetting fuel consumption statistics

- ▶ Press button or repeatedly until the first function of the trip computer menu appears in the multifunction display.
- ▶ Press button or repeatedly until the reading that you want to reset appears in the multifunction display.
- ▶ Press and hold the reset button in the instrument cluster (▷ page 136) until the value is reset to 0.

Calling up range (distance to empty)

- ▶ Switch on the ignition (▷ page 36).
- ▶ Press button  or  repeatedly until the first function of the trip computer menu appears in the multifunction display.
- ▶ Press button  or  repeatedly until the message **Range** appears in the multifunction display.

The calculated range based on the current fuel tank level appears in the multifunction display.



TEL menu*

Warning!





A driver's attention to the road must always be his/her primary focus when driving. For your safety and the safety of others, we recommend that you pull over to a safe location and stop before placing or taking a telephone call. If you choose to use the telephone while driving, please use the hands-free device and only use the telephone when weather, road and traffic conditions permit.

Some jurisdictions prohibit the driver from using a cellular telephone while driving a vehicle.

Bear in mind that at a speed of just 30 mph (approximately 50 km/h), your vehicle is covering a distance of 44 feet (approximately 14 m) every second.

Never operate radio transmitters equipped with a built-in or attached antenna (i.e. without being connected to an external antenna) from inside the vehicle while the engine is running. Doing so could lead to a malfunction of the vehicle's electronic system, possibly resulting in an accident and /or personal injury.

You can use the functions in the **Te1** menu to operate your telephone, provided it is connected to a hands-free system and switched on.

- ▶ Switch on the telephone and Audio or COMAND*.
- ▶ Press button  or  on the steering wheel repeatedly until the message **Te1** appears in the multifunction display.

Control system

Which messages will appear in the multifunction display depends on whether your telephone is switched on or off:

- If the telephone is off, the message **TEL off** appears in the multifunction display.
- If the telephone is on:

The telephone will then search for a network. During this time the multifunction display is empty.

As soon as the telephone has found a network, the message **READY** appears in the multifunction display.



This standby message indicates that your telephone is ready for use and you can operate it using the control system.

Answering a call

When your telephone is ready to receive calls, you can answer a call at any time. In the multifunction display you will then see the message:



- ▶ Press button .

You have answered the call. The duration of the call appears in the multifunction display.



If you do not wish to accept a call, press button .





Ending a call

- ▶ Press button .

You have ended the call. The standby message appears in the multifunction display.



Dialing a number from the phone book

If your telephone is ready to receive calls, you may select and dial a number from the phone book at any time.

- ▶ Press button  or  repeatedly until the message **TEL** appears in the multifunction display.
- ▶ Press button  or .

The control system reads the phone book which is stored in the telephone. This may take up to 30 seconds. The message **Please wait** appears in the multifunction display.

When the message **Please wait** disappears, the phone book has been loaded.



- ▶ Press button  or  repeatedly until the desired name appears in the multifunction display.

The stored names are displayed in ascending or descending alphabetical order.



- ① Name from the phone book



If you press and hold button  or  for longer than one second, the system scrolls rapidly through the list of names until you release the button again.

Cancel the quick search mode by pressing .

- ▶ Press button .

The system dials the selected phone number.



- If the connection is successful, the name of the party you called and the duration of the call will appear in the multifunction display.



- If no connection is made, the control system stores the dialed number in the redial memory.



Redialing

The control system stores the most recently dialed phone numbers. This eliminates the need to search through your entire phone book.

- ▶ Press button  or  repeatedly until the message Tel appears in the multifunction display.

- ▶ Press button .

The first number in the redial memory appears in the multifunction display.

- ▶ Press button  or  repeatedly until the desired name appears in the multifunction display.



If you do not want to use the telephone, press button .

- ▶ Press button .

The control system dials the selected phone number.

Automatic transmission

For more information on driving with an automatic transmission see “Automatic transmission” (▷ page 48).

Your vehicle’s transmission adapts its gear shifting process to your individual driving style by continually adjusting the shift points up or down. These shift point adjustments are performed based on current operating and driving conditions.

If the operating conditions change, the automatic transmission reacts by adjusting its shift program.



During the brief warm-up, transmission upshifting is delayed. This allows the catalytic converter to heat up more quickly to operating temperature.

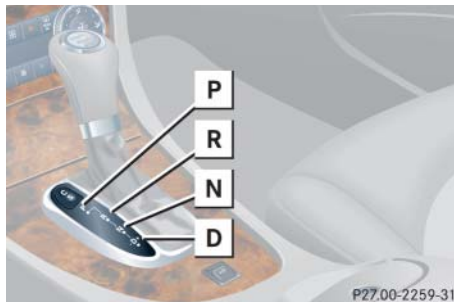

Gearshift pattern for automatic transmission

The automatic transmission selects individual gears automatically, depending on:

- the gear selector lever position **D** (▷ page 168) with gear ranges (▷ page 171)
- the selected program mode: **(C/S)** (▷ page 172)
or
(M/C/S) (CLK 55 AMG only) (▷ page 178)
- the position of the accelerator pedal (▷ page 170)
- the vehicle speed

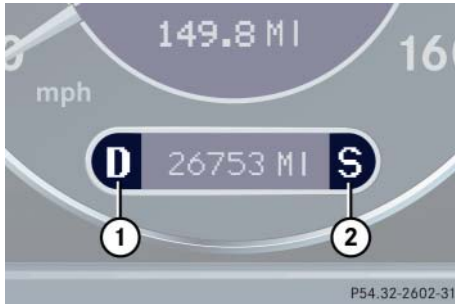

- ① Current gear range/gear selector lever position
- ② Current program mode

The current gear range/gear selector lever position and program mode (C/S) or (M/C/S) appear in the multifunction display.

An additional indication of the current gear selector lever position can be found on the cover of the shifting-gate.

The indicators come on when you activate a switch (e.g. unlocking the vehicle or opening a door) and go out after approximately 15 minutes.

Warning!



It is dangerous to shift the gear selector lever out of **P** or **N** if the engine speed is higher than idle speed. If your foot is not firmly on the brake pedal, the vehicle could accelerate quickly forward or reverse. You could lose control of the vehicle and hit someone or something. Only shift into gear when the engine is idling normally and when your right foot is firmly on the brake pedal.



Allow engine to warm up under low load use. Do not place full load on the engine until the operating temperature has been reached.

Shift into reverse gear **R** or parking position **P** only when the vehicle is stopped.

Avoid spinning of a drive wheel for an extended period when driving off on slippery road surfaces. This may cause serious damage to the drivetrain which is not covered by the Mercedes-Benz Limited Warranty.

When the gear selector lever is in position **D**, you can influence transmission shifting by:

- limiting the gear range
- changing gears manually

Automatic transmission

Gear selector lever position

	Effect
P	Park position Gear selector lever position when the vehicle is parked. Place gear selector lever in position P only when vehicle is stopped. The park position is not intended to serve as a brake when the vehicle is parked. Rather, the driver should always set the parking brake in addition to placing the gear selector lever in position P to secure the vehicle.

	Effect
	The SmartKey can only be removed from the starter switch with the gear selector lever in position P . With the SmartKey removed, the gear selector lever is locked in position P . If the vehicle's electrical system is malfunctioning, the gear selector lever could remain locked in position P (▷ page 422).
R	Reverse gear Place gear selector lever in position R only when vehicle is stopped.

	Effect
N	Neutral No power is transmitted from the engine to the drive axle. When the brakes are released, the vehicle can be moved freely (pushed or towed). To avoid damage to the transmission, never engage N while driving. If the ESP [®] is deactivated or malfunctioning: Move gear selector lever to N only if the vehicle is in danger of skidding, e.g. on icy roads.
D	Drive The transmission shifts automatically. All forward gears are available.



Coasting the vehicle, or driving for any other reason with gear selector lever in **N** can result in transmission damage that is not covered by the Mercedes-Benz Limited Warranty.

Warning!

Getting out of your vehicle with the gear selector lever not fully engaged in position **P** is dangerous. Also, position **P** alone is not intended to or capable of preventing your vehicle from moving, possibly hitting people or objects.

Always set the parking brake in addition to shifting to position **P** (> page 57).

When parked on an incline, turn the front wheels towards the road curb.

Do not park this vehicle in areas where combustible materials such as grass, hay or leaves can come into contact with the hot exhaust system, as these materials could be ignited and cause a vehicle fire.

Warning!

When leaving the vehicle, always remove the SmartKey or SmartKey with KEYLESS-GO* from the starter switch, take it with you, and lock the vehicle. Do not leave children unattended in the vehicle, or with access to an unlocked vehicle. Children could move the gear selector lever from position **P**, which could result in an accident and/or serious personal injury.

Automatic transmission

Driving tips

Accelerator position

Your driving style influences the transmission's shifting behavior:

Less throttle	Earlier upshifting
More throttle	Later upshifting

Kickdown

Use kickdown when you want maximum acceleration.

- ▶ Press the accelerator past the point of resistance.
The transmission shifts into a lower gear.
- ▶ Ease on the accelerator when you have reached the desired speed.
The transmission shifts up again.

Stopping

When you stop briefly, e.g. at traffic lights:

- ▶ Leave the transmission in gear.
- ▶ Hold the vehicle with the brake.

When you stop longer with the engine idling and/or on a hill:

- ▶ Set the parking brake.
- ▶ Move the gear selector lever to position **P**.

Maneuvering

When you maneuver in tight areas, e.g. when pulling into a parking space:

- ▶ Control the vehicle speed by gradually releasing the brakes.
- ▶ Accelerate gently.
- ▶ Never abruptly step on the accelerator.

Working on the vehicle

Warning!



When working on the vehicle, set the parking brake and move gear selector lever to position **P**. Otherwise the vehicle could roll away.

Gear ranges

With the gear selector lever in position **D** and driving in the automatic shift program **C** or **S** (▷ page 172), you can select a gear range for the automatic transmission to operate within:

Gear selector lever (▷ page 173):

You can limit the gear range by pressing the gear selector lever to the left (**D-**), and reverse the gear range limit by pressing the gear selector lever to the right (**D+**).

Steering wheel gearshift control

(CLK 500/CLK 55 AMG) (▷ page 174):

You can limit the gear range by pressing the respective downshift button on the steering wheel gearshift control, and reverse the gear range limit by pressing the respective upshift button on the steering wheel gearshift control.

The selected gear range appears in the multifunction display (▷ page 167). If you press on the accelerator when the engine has reached its rpm limit, the transmission will upshift beyond any gear range limit selected.

	Effect
6	The transmission shifts through sixth gear only (applies to vehicles with 7-speed automatic transmission only).
5	The transmission shifts through fifth gear only (applies to vehicles with 7-speed automatic transmission only).
4	The transmission shifts through fourth gear only.

	Effect
3	The transmission shifts through third gear only. With this selection you can use the braking effect of the engine.
2	The transmission shifts through second gear only. Allows the use of engine's braking power when driving: <ul style="list-style-type: none"> • on steep downgrades • in mountainous regions • under extreme operating conditions
1	The transmission operates in first gear only. For maximum use of engine's braking effect on very steep or lengthy downgrades.

Automatic transmission

Automatic shift program

The program mode selector switch is located on the lower part of the center console.

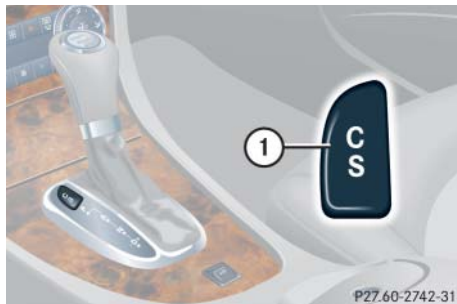

① Program mode selector switch

C Comfort For comfort driving

S Sport For standard driving

The current gear selector lever position and the selected program mode (C/S) are indicated in the multifunction display (▷ page 167).



Never change the program mode when the gear selector lever is out of position **P**. This could result in a change of driving characteristics for which you may not be prepared.



The last selected program mode (**C** or **S**) is switched on when the engine is restarted.

- ▶ Press program mode selector switch ① repeatedly until the letter of the desired program mode appears in the multifunction display.

Select **C** for comfort driving:

- The vehicle starts out in second gear (both forward and reverse) for gentler starts. This does not apply if full throttle is applied or gear range **1** is selected.
- Traction and driving stability are improved on icy roads.
- Upshifts occur earlier even when you give more gas. The engine then operates at lower rpms and the wheels are less likely to spin.

Gear selector lever one-touch gearshifting

Even with an automatic transmission, you can change the gears manually and limit or extend the gear range for automatic shifting with the gear selector lever in position **D** and driving in the automatic program mode **C** or **S**.



Allow engine to warm up under low load use. Do not place full load on the engine until the operating temperature has been reached.

Shift into reverse gear **R** or parking position **P** only when the vehicle is stopped.

Avoid spinning of a drive wheel for an extended period when driving off on slippery road surfaces. This may cause serious damage to the drivetrain which is not covered by the Mercedes-Benz Limited Warranty.

Downshifting

Warning!



On slippery road surfaces, never downshift in order to obtain braking action. This could result in drive wheel slip and reduced vehicle control. Your vehicle's ABS will not prevent this type of loss of control.

- ▶ Briefly press the gear selector lever to the left in the **D-** direction.

The transmission will shift from the current gear to the next lower gear as permitted by the shift program. This action simultaneously limits the gear range of the transmission (▷ page 171).



To avoid overrevving the engine when the gear selector lever is moved to the **D-** direction, the transmission will not shift to a lower gear if the engine's max. speed would be exceeded.

Upshifting

- ▶ Briefly press the gear selector lever to the right in the **D+** direction.

The transmission will shift from the current gear to the next higher gear as permitted by the shift program. This action simultaneously extends the gear range of the transmission.

Canceling gear range limit

- ▶ Press and hold the gear selector lever in the **D+** direction until **D** reappears in the multifunction display.

The transmission will shift from the current gear range directly to gear range **D**.

Shifting into optimal gear range

- ▶ Press and hold the gear selector lever in the **D-** direction.

The transmission will automatically select the gear range suited for optimal acceleration and deceleration. This may involve shifting down one or more gears.

Automatic transmission

Steering wheel gearshift control one-touch gearshifting

The steering wheel gearshift control provides an alternative method for changing the gears manually and limiting or extending the gear range for automatic shifting with the gear selector lever in position **D** and driving in the automatic program mode **C** or **S**.



For information on using the steering wheel gearshift control in manual program mode **M** (CLK 55 AMG only), see “Manual shift program” (▷ page 178).



To avoid overrevving the engine when downshifting with steering wheel gearshift buttons, the transmission will not shift to a lower gear if the engine's max. speed would be exceeded.



Allow engine to warm up under low load use. Do not place full load on the engine until the operating temperature has been reached.

Shift into reverse gear **R** or parking position **P** only when the vehicle is stopped.

Avoid spinning of a drive wheel for an extended period when driving off on slippery road surfaces. This may cause serious damage to the drivetrain which is not covered by the Mercedes-Benz Limited Warranty.

Steering wheel gearshift control CLK 500

The steering wheel gearshift buttons are located to the left and right of the steering wheel.



- ① Button, inside: downshift
- ② Button, outside: upshift



You cannot shift with the steering wheel gearshift buttons when the gear selector lever is in position **P**, **N** or **R**.

The last selected automatic program mode (**C** or **S**) is switched on when the engine is restarted.

Downshifting

Warning!



On slippery road surfaces, never downshift in order to obtain braking action. This could result in drive wheel slip and reduced vehicle control. Your vehicle's ABS will not prevent this type of loss of control.

- ▶ Briefly press the inside ① of one of the buttons on the steering wheel.

The transmission will shift to the next lower gear as permitted by the shift program. This action simultaneously limits the gear range of the transmission (▷ page 171).

Upshifting

- ▶ Briefly press the outside ② of one of the buttons on the steering wheel.

The transmission will shift to the next higher gear as permitted by the shift program. This action simultaneously extends the gear range of the transmission.

Canceling gear range limit

- ▶ Press and hold the outside ② of one of the buttons on the steering wheel until **D** reappears in the multifunction display.

The transmission will shift from the current gear range directly to gear range **D**.

Shifting into optimal gear range

- ▶ Press and hold the inside ① of one of the buttons on the steering wheel.

The transmission will automatically select the gear range suited for optimal acceleration and deceleration. This may involve shifting down one or more gears.

Automatic transmission

Steering wheel gearshift control CLK 55 AMG

The steering wheel gearshift buttons are located to the left and right of the steering wheel.



- ① Left button: downshift
- ② Right button: upshift



You cannot shift with the steering wheel gearshift buttons when the gear selector lever is in position **P**, **N** or **R**.

The last selected program mode (**C** or **S**) is switched on when the engine is restarted in the automatic program mode.

The following instructions describe operation of the steering wheel gearshift control when driving in the automatic program mode **C** or **S**.

For instructions on operating the steering wheel gearshift control and gear selector lever in the manual program mode **M**, see “Manual shift program CLK 55 AMG” (▷ page 178).

Downshifting

Warning!



On slippery road surfaces, never downshift in order to obtain braking action. This could result in drive wheel slip and reduced vehicle control. Your vehicle's ABS will not prevent this type of loss of control.

- ▶ Briefly press button ① on the left side of the steering wheel.

The transmission will shift to the next lower gear as permitted by the shift program. This action simultaneously limits the gear range of the transmission (▷ page 171) when you are driving in the automatic program mode (**C** or **S**).

Upshifting

- ▶ Briefly press button ② on the right side of the steering wheel.

The transmission will shift to the next higher gear as permitted by the shift program. This action simultaneously extends the gear range of the transmission when you are driving in the automatic program mode (**C** or **S**).

Canceling gear range limit

- ▶ Press and hold button ② on the right side of the steering wheel until D reappears in the multifunction display.

The transmission will shift from the current gear range directly to gear range **D**.

Shifting into optimal gear range

- ▶ Press and hold button ① on the left side of the steering wheel.

The transmission will automatically select the gear range suited for optimal acceleration and deceleration. This may involve shifting down one or more gears.

Automatic transmission

Manual shift program CLK 55 AMG

In addition to the automatic shift program **C** or **S**, your vehicle is equipped with the manual shift program **M**.

In the manual program mode **M**, system-controlled automatic gearshifting is switched off and you need to change the gears by manually upshifting or downshifting using the steering wheel gearshift buttons to the left and right of the steering wheel (▷ page 176) or the gear selector lever.



Allow engine to warm up under low load use. Do not place full load on the engine until the operating temperature has been reached.

Shift into reverse gear **R** or parking position **P** only when the vehicle is stopped.

Avoid spinning of a drive wheel for an extended period when driving off on slippery road surfaces. This may cause serious damage to the drivetrain which is not covered by the Mercedes-Benz Limited Warranty.

The program mode selector switch is located on the lower part of the center console.

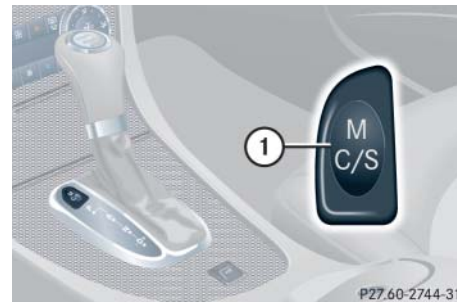

① Program mode selector switch

M Manual	For manual gear shifting
C Comfort	For comfort driving
S Sport	For standard driving

The current gear selector lever position and the selected program mode (M/C/S) are indicated in the multifunction display (▷ page 167).



For information on automatic program modes **C** or **S**, see “Automatic shift program” (▷ page 172), “Gear selector lever one-touch gearshifting” (▷ page 173), and “Steering wheel gearshift control one-touch gearshifting” (▷ page 174).

Activating manual shift program

- ▶ Press program mode selector switch ① repeatedly until the **M** for manual program mode **M** appears in the multifunction display.

The transmission switches to the manual program mode **M**. Automatic shifting is switched off. The gear range is not limited.

You can change the gears manually when the gear selector lever is in position **D**. You can upshift or downshift through the gears in succession.



The manual program mode **M** will not be stored. When the engine is turned off with the manual program mode **M** selected, the transmission will go to the automatic program mode (**C** or **S**) when the engine is restarted.

Upshifting



In the manual program mode **M**, the transmission will not upshift, even if the engine has reached its overrevving range. Shift up to the next gear before the engine has reached its overrevving range. Make absolutely certain that the engine speed does not reach the red marking on the tachometer (▷ page 24). Otherwise the engine could be damaged which is not covered by the Mercedes-Benz Limited Warranty.

- ▶ Briefly press the gear selector lever to the right in the **D+** direction.

or

- ▶ Briefly press button ② on the right side of the steering wheel (▷ page 176).

The transmission shifts to the next higher gear.

If, instead of the manual program mode symbol **M**, the  symbol appears in the multifunction display (▷ page 167), shift to the next higher gear. The fuel supply will otherwise be interrupted to prevent the engine from overrevving.

Automatic transmission

Downshifting

Warning!



On slippery road surfaces, never downshift in order to obtain braking action. This could result in drive wheel slip and reduced vehicle control. Your vehicle's ABS will not prevent this type of loss of control.

- ▶ Briefly press the gear selector lever to the left in the **D**- direction.

or

- ▶ Briefly press button **1** on the left side of the steering wheel (▷ page 176).

The transmission shifts to the next lower gear.



When you brake or stop, the transmission shifts down to a gear from which you can easily accelerate or take off.

Kickdown

Using the kickdown when driving in the manual program mode **M** is not possible.

Deactivating manual shift program

- ▶ Press the program mode selector switch (▷ page 178) repeatedly until **C** or **S** appears in the multifunction display.

or

- ▶ Restart the engine.

The transmission will go to the automatic program mode (**C** or **S**).

The manual program mode **M** is not stored.

Emergency operation (Limp Home Mode)

If vehicle acceleration worsens or the transmission no longer shifts, the transmission is most likely operating in limp home (emergency operation) mode. In this mode only second gear and reverse gear can be activated.

- ▶ Stop the vehicle.
- ▶ Move gear selector lever to **P**.
- ▶ Turn off the engine.
- ▶ Wait at least ten seconds before restarting.
- ▶ Restart the engine.
- ▶ Move gear selector lever to position **D** (for second gear) or **R**.
- ▶ Have the transmission checked at an authorized Mercedes-Benz Center as soon as possible.

▼ Good visibility

For information on the windshield wipers, see “Windshield wipers” (▷ page 53).

Headlamp cleaning system*

The button is located on the left side of the dashboard.



① Headlamp washer button

- ▶ Switch on the ignition (▷ page 36).
- ▶ Press button ①.

The headlamps are cleaned with a high-pressure water jet.



The headlamps will automatically be cleaned when you have

- switched on the headlamps and
- operated the windshield wipers with windshield washer fluid fifteen times

When you switch off ignition, the counter resets.

For information on filling up the washer reservoir, see “Windshield washer system and headlamp cleaning system*” (▷ page 486).

Rear view mirrors

For more information on setting the rear view mirrors, see “Mirrors” (▷ page 43).

Interior rear view mirror, antiglare position

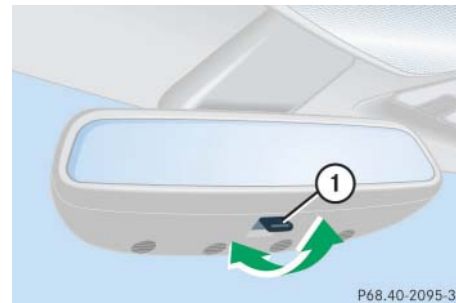

① Lever

- ▶ Tilt the mirror to the antiglare night position by moving lever ① towards the windshield.

The interior rear view mirror is dimmed.

Good visibility

Auto-dimming rear view mirrors*

The reflection brightness of the exterior rear view mirror on the driver's side and the interior rear view mirror will respond automatically to glare when

- the ignition is switched on, and
- incoming light from headlamps falls on the sensor in the interior rear view mirror.

The rear view mirror will not react if

- reverse gear **R** is engaged
- the interior lighting is turned on

Warning!



The auto-dimming function does not react if incoming light is not aimed directly at sensors in the interior rear view mirror.

The interior rear view mirror and the exterior rear view mirror on the driver's side do not react, for example, if the wind screen is installed.

Glare can endanger you and others.

Warning!



In case of an accident, liquid electrolyte may escape from the mirror housing if the mirror glass breaks.

Electrolyte has an irritating effect. Do not allow the liquid to come into contact with eyes, skin, clothing, or respiratory system. In case it does, immediately flush affected area with water, and seek medical help if necessary.



Electrolyte drops coming into contact with the vehicle paint finish can be completely removed only while in the liquid state and by applying plenty of water.

Warning!



Exercise care when using the passenger-side exterior rear view mirror. The mirror surface is convex (outwardly curved surface for a wider field of view). Objects in mirror are closer than they appear. Check your interior rear view mirror or glance over your shoulder before changing lanes.

Activating exterior rear view mirror parking position

Follow these steps to activate the mirror parking position so that the passenger-side exterior rear view mirror will be turned downward to the stored position.

The buttons are located above the exterior lamp switch.



- ① Driver's side exterior rear view mirror button
- ② Passenger-side exterior rear view mirror button

- ▶ Make sure you have stored a parking position for the passenger-side exterior rear view mirror (▷ page 126).
- ▶ Make sure the **Mirror adjustment parking aid function in the Convenience submenu of the control system** is switched to on (▷ page 161).
- ▶ Switch on the ignition (▷ page 34).
- ▶ Press button ② for the passenger-side exterior rear view mirror.
- ▶ Place the gear selector lever in reverse gear **R**.

The passenger-side exterior rear view mirror will be turned downward to the stored position.

The exterior rear view mirror returns to its previously stored driving position:

- ten seconds after you put the gear selector lever out of position **R**
- immediately once your vehicle exceeds a speed of approx. 6 mph (10 km/h)
- immediately when you press button ① for the driver's side mirror.

Good visibility

Sun visors

The sun visors protect you from sun glare while driving.

Warning!



Do not use the vanity mirror while driving.

Keep the mirrors in the sun visors closed while vehicle is in motion. Reflected glare can endanger you and others.

- ▶ Swing sun visor ④ down when you experience glare.

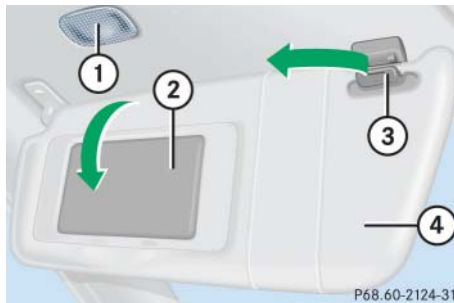

P68.60-2124-31

- ① Mirror lamp
- ② Mirror cover
- ③ Mounting
- ④ Sun visor

- ▶ To use the illuminated mirror, lift up mirror cover ②.



If sun visor ④ is disengaged from mounting ③ with mirror cover ② open, mirror lamp ① will switch off.

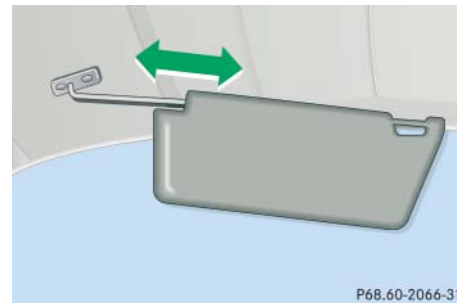

P68.60-2066-31

If sunlight enters through a side window:

- ▶ disengage sun visor from mounting ③.
- ▶ pivot sun visor to the side.

The sun visors are extendable.

- ▶ Adjust the sun visors by pushing or pulling in the direction of the arrows.





Close mirror cover ② (if open) before you disengage the sun visor ④ from mounting ③ and pivot it to the side.

Rear window defroster

The rear window defroster uses a large amount of power. To keep the battery drain to a minimum, switch off the defroster as soon as the rear window is clear. The defroster is automatically deactivated after approximately 6 to 17 minutes of operation depending on the outside temperature.

Activating

- ▶ Press button  or  in the climate control panel (▷ page 187) or automatic climate control panel (▷ page 197).

The indicator lamp on the button comes on.

Deactivating

- ▶ Press button  or  again.

The indicator lamp on the button goes out.

Warning!



Any accumulation of snow and ice should be removed from the rear window before driving. Visibility could otherwise be impaired, endangering you and others.



If the rear window defroster switches off too soon and the indicator lamp starts flashing, this means that too many electrical consumers are operating simultaneously and there is insufficient voltage in the battery. The system responds automatically by deactivating the rear window defroster.

As soon as the battery has sufficient voltage, the rear window defroster automatically switches on again.

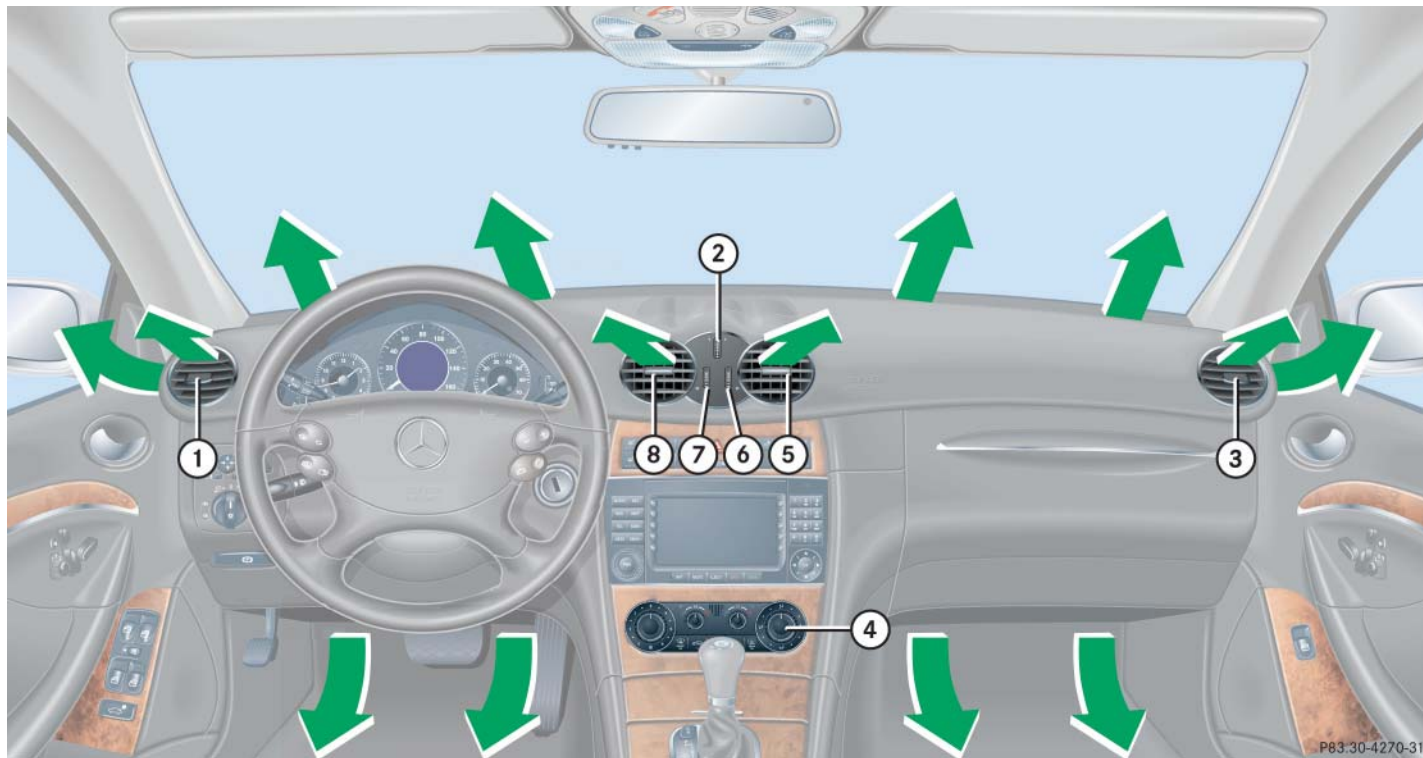

Climate control (CLK 350)

Item
① Left side air vent, adjustable
② Thumbwheel for air volume control for center air vents
③ Right side air vent, adjustable
④ Climate control panel
⑤ Right center air vent, adjustable
⑥ Thumbwheel for air volume control for right side center air vent
⑦ Thumbwheel for air volume control for left side center air vent
⑧ Left center air vent, adjustable



For draft-free ventilation, move the sliders for the side air vents ① and ③ and center air vents ⑤ and ⑧ to the middle position.



Canada only



USA only

Item
① Air volume control
② Left side temperature control
③ Right side temperature control
④ Air distribution control
⑤ Rear window defroster
⑥ AC cooling on/off
⑦ Air distribution and air volume (automatic mode)
⑧ Air recirculation
⑨ Front defroster

Climate control (CLK 350)

The climate control is operational whenever the engine is running. You can operate the climate control system in either the automatic or manual mode. The system cools or heats the interior depending on the selected interior temperature and the current outside temperature.

Warning!



When operating the climate control, the air that enters the passenger compartment through the air vents can be very hot or very cold (depending on the set temperature). This may cause burns or frostbite on unprotected skin in the immediate area of the air vents. Always keep sufficient distance between unprotected parts of the body and the air vents. If necessary, use the air distribution control (> page 187) to direct the air to air vents in the vehicle interior that are not in the immediate area of unprotected skin.

Nearly all dust particles, pollutants and odors are filtered out before outside air enters the passenger compartment through the air distribution system.

The air conditioning will not engage (no cooling) if the **A/C** mode is deactivated (> page 194).

Warning!



Follow the recommended settings for heating and cooling given on the following pages. Otherwise the windows could fog up, impairing visibility and endangering you and others.



Severe conditions (e.g. strong air pollution) may require replacement of the filter before its scheduled interval. A clogged filter will reduce the air volume to the interior.

If the vehicle interior is hot, ventilate the interior before driving off, see “Summer opening feature” (> page 252). The climate control will then adjust the interior temperature to the set value much faster.

Keep the air intake grille in front of the windshield free of snow and debris.

Do not obstruct air flow by placing objects on the air flow-through exhaust slots below the rear window.

Deactivating the climate control system

Deactivating

- ▶ Set air volume control ① (▷ page 187) to position **0**.



When the climate control system is deactivated, the outside air supply and circulation are also deactivated. Only choose this setting for a short time. Otherwise the windows could fog up.

Reactivating

- ▶ Set air volume control ① (▷ page 187) to any speed.

Operating the climate control system in automatic mode



When operating the climate control system in automatic mode, you will only rarely need to adjust the temperature, air volume and air distribution.

In automatic mode, cooling with dehumidify is switched on. This function can be switched off if necessary.

Activating

- ▶ Press button **AUTO** (▷ page 187) while the engine is running.

The indicator lamp on the button comes on. The air volume and air distribution are adjusted automatically.

- ▶ Use temperature controls ② and ③ (▷ page 187) to separately adjust the air temperature on each side of the passenger compartment.

The temperature of the vehicle interior is adjusted automatically.

Deactivating

- ▶ Press button **AUTO** (▷ page 187) again.

The indicator lamp on the button goes out. The automatic operation of air volume and air distribution switches off.

Climate control (CLK 350)

Setting the temperature

Use temperature controls ② and ③ (▷ page 187) to separately adjust the air temperature on each side of the passenger compartment. You should raise or lower the temperature setting in small increments, preferably starting at 72°F (22°C). The climate control will adjust to the set temperature as fast as possible.

Increasing

- ▶ Turn temperature control ② and/or ③ (▷ page 187) slightly clockwise.

The climate control system will correspondingly adjust the interior air temperature.





Decreasing

- ▶ Turn temperature control ② and/or ③ (▷ page 187) slightly counterclockwise.

The climate control system will correspondingly adjust the interior air temperature.

Adjusting air distribution

Use air distribution control ④ (▷ page 187) to adjust the air distribution. The following symbols are located on the controls:

Symbol	Function
	Directs air through the center, side and rear passenger compartment air vents
	Directs air to the windshield and the side defroster vents
	Directs air into the entire vehicle interior
	Directs air to the footwells

- ▶ Press button **AUTO** (▷ page 187).

The indicator lamp on the button goes out. The automatic air distribution is switched off. The air distribution is controlled according to the selected control setting

- ▶ Turn air distribution control ④ (▷ page 187) to the desired symbol.

Opening center and side air vents

- ▶ Turn thumbwheels ②, ⑥ and ⑦ (▷ page 186) upward.

The side air vents ① and ③ and center air vents ⑤ and ⑧ are open.

Closing center and side air vents

- ▶ Turn thumbwheels ②, ⑥ and ⑦ (▷ page 186) downward.

The side air vents ① and ③ and center air vents ⑤ and ⑧ are closed.

Adjusting air volume

Six blower speeds are available.

- ▶ Press button **AUTO** (▷ page 187).

The indicator lamp on the button goes out. The automatic air volume control is switched off. The air volume is controlled according to the currently selected control setting.

- ▶ Use the air volume control ① (▷ page 187) to adjust the air volume.



Front defroster

You can use this setting to defrost the windshield, for example if it is iced up. You can also defog the windshield and the side windows.



Keep this setting selected only until the windshield or the side windows are clear again.

Activating



- ▶ Press button  or  (▷ page 187).

The indicator lamp on the button comes on.

The air conditioning switches automatically to the following functions:

- cooling on to dehumidify
- maximum blowing and heating power
- air flows onto the windshield and the front side windows
- the air recirculation mode is switched off

Deactivating

- ▶ Press button  or  (▷ page 187) again.

The indicator lamp on the button goes out. Defrosting is turned off.



The cooling remains switched on.

Climate control (CLK 350)

Windshield fogged on the outside



Keep this setting selected only until the windshield is clear again.

- ▶ Switch the windshield wipers on (▷ page 54).
- ▶ Press button **AUTO** (▷ page 187).

The indicator lamp on the button comes on. Air distribution and air volume are adjusted automatically.

If the automatic mode of the climate control is switched off:

- ▶ Turn air distribution control ④ to or (▷ page 187).

Air recirculation mode

Switch to air recirculation mode to prevent unpleasant odors from entering the vehicle from the outside (e.g. before driving through a tunnel). This setting cuts off the intake of outside air and recirculates the air in the passenger compartment.

Warning!



Fogged windows impair visibility, endangering you and others. If the windows begin to fog on the inside, switching off the air recirculation mode immediately should clear interior window fogging. If interior window fogging persists, make sure the air conditioning (▷ page 194) is activated, or press button or .

Activating

- ▶ Press button (▷ page 187).

The indicator lamp on the button comes on.



The air recirculation mode is activated automatically at high outside temperatures.

The indicator lamp on button is not lit when the air recirculation mode is automatically switched on.

A quantity of outside air is added after approximately 30 minutes.

Warning!

Never operate the side windows if there is the possibility of anyone being harmed by the closing procedure.

In the event that the procedure causes potential danger, the closing of the side windows can be immediately halted by releasing the  button or by pressing or pulling the respective window switch.



If you press and hold button , the side windows will close.

Deactivating

► Press button  (▷ page 187).

The indicator lamp on the button goes out.





The air recirculation mode is deactivated automatically:

- after 5 minutes if the outside temperature is below approximately 41°F (5°C)
- after 5 minutes if the air conditioning is turned off
- after 30 minutes if the outside temperature is above approximately 41°F (5°C)



If you press and hold button , the side windows will return to their previous position.

A side window will only return to its previous position if it has not been moved to another position using the respective side window switch after it was closed with button . A side window that was moved will remain in its current position if button  is used to re-open the remaining side windows.

Climate control (CLK 350)

Air conditioning

The cooling function, is only operational when the engine is running, cools the vehicle interior down to the selected temperature. The cooling function also dehumidifies the air in the vehicle interior, thus preventing the windows from fogging up.



Condensation may drip out from underneath the vehicle. This is normal and not an indication of a malfunction.

Warning!



If you turn off the cooling function, the vehicle will not be cooled when weather conditions are warm. The windows can fog up more quickly. Window fogging may impair visibility and endanger you and others.

Deactivating

It is possible to deactivate the air conditioning (cooling) function of the climate control system. The air in the vehicle will then no longer be cooled or dehumidified.

- ▶ Press button  (▷ page 187).

The indicator lamp on the button goes out.

The cooling function switches off after a short delay.

Activating

Moist air can fog up the windows. You can dehumidify the air with the air conditioning.

- ▶ Press button  (▷ page 187) again.

The indicator lamp on the button comes on.

The air conditioning uses the refrigerant R134a. This refrigerant is free of CFCs which are harmful to the ozone layer.



If the air conditioning cannot be turned on again, this indicates that the air conditioning is losing refrigerant. The compressor has turned itself off.

Have the air conditioning checked at the nearest authorized Mercedes-Benz Center.

Rear passenger compartment adjustable air vents

The air conditioning for the rear passenger compartment is controlled via the climate control panel (▷ page 187).



The temperature at the center air vents for the rear passenger compartment ② and ③ (▷ page 195) is the same as at the dashboard center air vents.

The air vents for the rear passenger compartment are located in the rear center console.

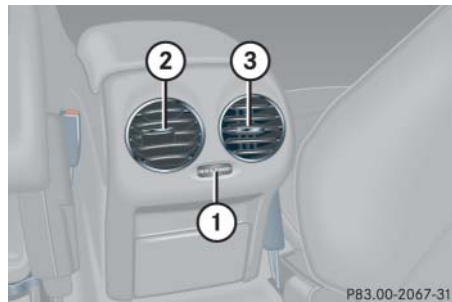

- ① Thumbwheel for air volume control for center air vents
- ② Left center air vent
- ③ Right center air vent

Adjusting air distribution

- ▶ Push the slide for the left center vent ② or right center vent ③ to the left, right, up or down.

The air flow is directed in the corresponding direction.



For draft-free ventilation, push slides ② and ③ upward.

Adjusting air volume

- ▶ Turn thumbwheel ① to the left or right.

The air volume is increased or decreased.

Automatic climate control (CLK 500/CLK 55 AMG)

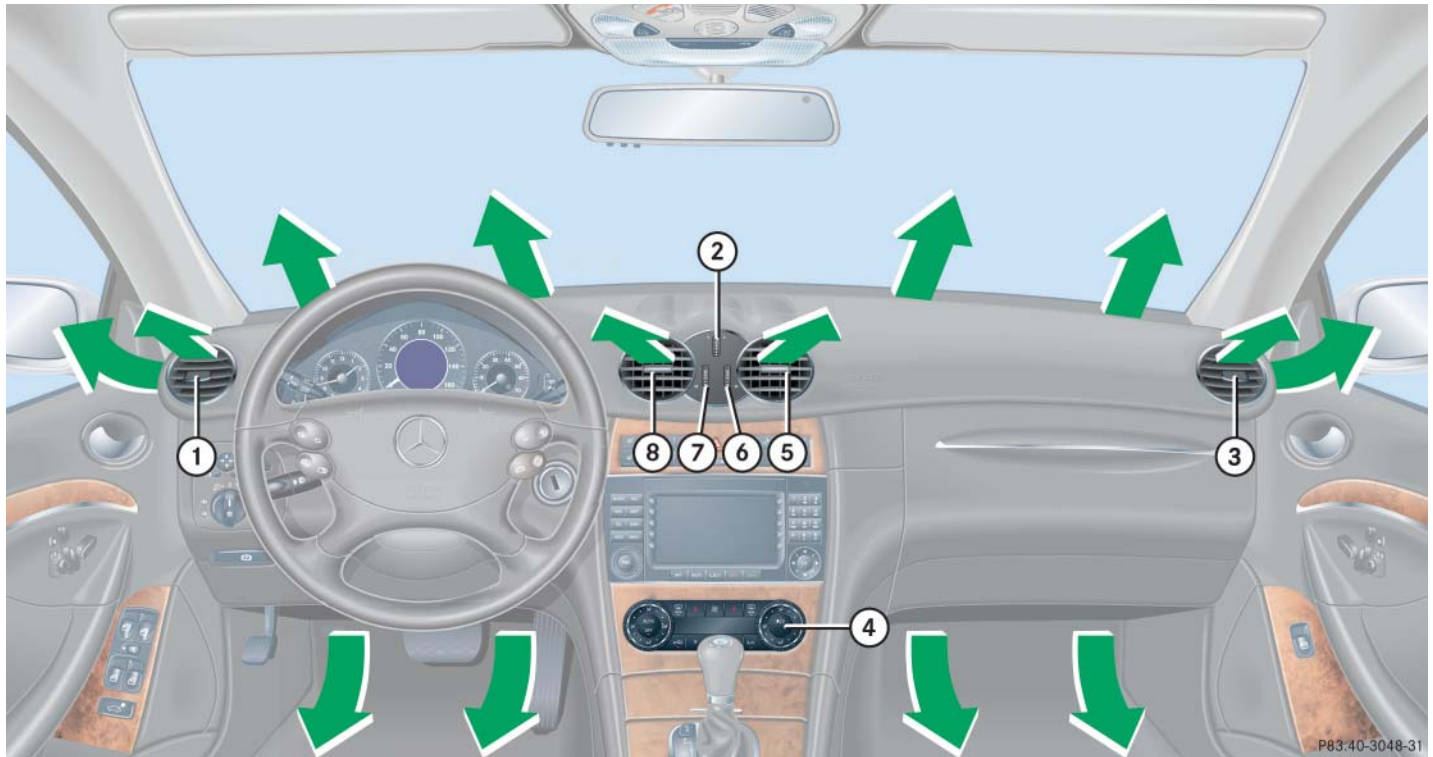

Automatic climate control (CLK 500/CLK 55 AMG)

Item
① Left side air vent, adjustable
② Thumbwheel for air volume control for center air vents
③ Right side air vent, adjustable
④ Automatic climate control panel
⑤ Right center air vent, adjustable
⑥ Thumbwheel for air volume control for right side center air vent
⑦ Thumbwheel for air volume control for left side center air vent
⑧ Left center air vent, adjustable



For draft-free ventilation, move the sliders for the center air vents ①, ③, ⑤, ⑧ to the middle position.



Canada only



USA only

Item
① Left side air distribution control
② Front defroster

Item
③ Temperature control, left, raising
④ Display
⑤ Air volume control, raising
⑥ Temperature control, right, raising
⑦ Rear window defroster
⑧ Right side air distribution control
⑨ Charcoal filter
⑩ AC cooling on/off Residual heat/ventilation (Canada only)
⑪ Temperature control, right, lowering
⑫ Air volume control, lowering
⑬ Temperature control, left, lowering
⑭ Air recirculation
⑮ Automatic climate control on/off (complete system)
⑯ Air distribution and air volume (automatic mode)

Automatic climate control (CLK 500/CLK 55 AMG)

The automatic climate control is operational whenever the engine is running. You can operate the climate control system in either the automatic or manual mode. The system cools or heats the interior depending on the selected interior temperature and the current outside temperature.

Warning!



When operating the automatic climate control, the air that enters the passenger compartment through the air vents can be very hot or very cold (depending on the set temperature). This may cause burns or frostbite on unprotected skin in the immediate area of the air vents. Always keep sufficient distance between unprotected parts of the body and the air vents. If necessary, use the air distribution controls (▷ page 197) to direct the air to air vents in the vehicle interior that are not in the immediate area of unprotected skin.

Nearly all dust particles, pollutants and odors are filtered out before outside air enters the passenger compartment through the air distribution system.

The air conditioning will not engage (no cooling) if the **A/C** mode is deactivated (▷ page 206).

Warning!



Follow the recommended settings for heating and cooling given on the following pages. Otherwise the windows could fog up, impairing visibility and endangering you and others.



Severe conditions (e.g. strong air pollution) may require replacement of the filter before its scheduled interval. A clogged filter will reduce the air volume to the interior.

If the vehicle interior is hot, ventilate the interior before driving off, see “Summer opening feature” (▷ page 252). The automatic climate control will then adjust the interior temperature to the set value much faster.

Keep the air intake grille in front of the windshield free of snow and debris.

Do not obstruct air flow by placing objects on the air flow-through exhaust slots below the rear window.

Automatic climate control (CLK 500/CLK 55 AMG)

Deactivating the automatic climate control system

Deactivating

- ▶ Press button **OFF** (▷ page 197).

The indicator lamp on the button **OFF** comes on.



When the air conditioning is switched off, the outside air supply and circulation are also switched off. Only choose this setting for a short time. Otherwise the windows could fog up.

Reactivating

- ▶ Press button **OFF** (▷ page 197).

The indicator lamp on the button **OFF** goes out.

Operating the climate control system in automatic mode



When operating the climate control system in automatic mode, you will only rarely need to adjust the temperature, air volume and air distribution.

In automatic mode, cooling with dehumidify is switched on. This function can be switched off if necessary.



You can switch the automatic climate control system on and off for each side of the passenger compartment as desired.

Activating

- ▶ Press button **AUTO** (▷ page 197) while the engine is running.

The indicator lamp on the button comes on. The air volume and air distribution are adjusted automatically.

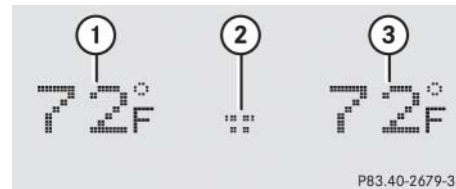

- ① Temperature, left
- ② Blower speed
- ③ Temperature, right

- ▶ Use temperature controls ③ and ⑬ or ⑥ and ⑪ (▷ page 197) to separately adjust the air temperature on each side of the passenger compartment.

The temperature of the vehicle interior is adjusted automatically.

Deactivating

- ▶ Press button **AUTO** (▷ page 197) again.

The indicator lamp on the button goes out. The automatic operation of air volume and air distribution switches off.

Automatic climate control (CLK 500/CLK 55 AMG)

Setting the temperature

Use temperature controls ③ and ⑬ for the left side or ⑥ and ⑪ for the right side (▷ page 197) to separately adjust the air temperature on each side of the passenger compartment. You should raise or lower the temperature setting in small increments, preferably starting at 72°F (22°C). The automatic climate control will adjust to the set temperature as fast as possible.

Increasing

- ▶ Press and hold temperature button ③ and/or ⑥ (▷ page 197) until the desired temperature appears in the display of the control panel ④ (▷ page 197).

The automatic climate control system will correspondingly adjust the interior air temperature.





Decreasing

- ▶ Press and hold temperature button ⑪ and/or ⑬ (▷ page 197) until the desired temperature appears in the display of the control panel ④ (▷ page 197).

The automatic climate control system will correspondingly adjust the interior air temperature.

Adjusting air distribution

Use the air distribution controls ① and ⑧ (▷ page 197) to separately adjust the air distribution on each side of the passenger compartment. The following symbols are located on the controls:

Symbol	Function
	Directs air to the windshield and the side defroster vents
	Directs air into the entire vehicle interior
	Directs air to the footwells
	Directs air through the center, side and rear passenger compartment air vents

Automatic climate control (CLK 500/CLK 55 AMG)

- ▶ Turn air distribution control ① or ⑧ (▷ page 197) to the desired symbol.

The indicator lamp on the button **AUTO** goes out.

The automatic air distribution is switched off. The air distribution is controlled according to the selected control setting.



You can also turn the air distribution control to a position between two symbols

Opening center and side air vents

- ▶ Turn thumbwheels ②, ⑥ and ⑦ (▷ page 196) upward.



The center air vents ⑤ and ⑧ and side air vents ① and ③ (▷ page 196) are open.

Closing center and side air vents



- ▶ Turn thumbwheels ②, ⑥ and ⑦ (▷ page 196) downward.

The center air vents ⑤ and ⑧ and side air vents ① and ③ (▷ page 196) are closed.

Adjusting air volume

Use button **AUTO** (▷ page 197) for automatic mode or air volume controls  or  (▷ page 197) to adjust air volume manually.

Seven blower speeds are available.

- ▶ Press button  to decrease or  (▷ page 197) to increase air volume to the desired level.

The indicator lamp on the button **AUTO** goes out.

The automatic air distribution remains switched on.



Front defroster

You can use this setting to defrost the windshield, for example if it is iced up. You can also defog the windshield and the side windows.



Keep this setting selected only until the windshield or the side windows are clear again.

Activating

- ▶ Press button  or  (▷ page 197).



The indicator lamp on the button comes on.

Automatic climate control (CLK 500/CLK 55 AMG)

The air conditioning switches automatically to the following functions:

- cooling on the dehumidify
- maximum blowing and heating power
- air flows onto the windshield and the front side windows
- the air recirculation mode is switched off

Deactivating

- ▶ Press button  or  (▷ page 197) again.

The indicator lamp on the button goes out.

The previous settings are once again in effect.



The cooling remains switched on.



Windshield fogged on the outside



Keep this setting selected only until the windshield is clear again.

- ▶ Switch the windshield wipers on (▷ page 54).

If the automatic mode of the automatic climate control is switched off:

- ▶ Turn air distribution control ① or ⑧ to  or  (▷ page 197).

Maximum cooling MAXCOOL

If the left and right air distribution controls as well as the airflow volume control are set to **AUTO** (▷ page 197) and there is a high need for cooling, the display “MAXCOOL” appears.



This provides the fastest possible cooling of the vehicle interior (when side windows and soft top are closed).

Automatic climate control (CLK 500/CLK 55 AMG)

Air recirculation mode

Switch to air recirculation mode to prevent unpleasant odors from entering the vehicle from the outside (e.g. before driving through a tunnel). This setting cuts off the intake of outside air and recirculates the air in the passenger compartment.

Warning!

Fogged windows impair visibility, endangering you and others. If the windows begin to fog on the inside, switching off the air recirculation mode immediately should clear interior window fogging. If interior window fogging persists, make sure the air conditioning (▷ page 206) is activated, or press button  or .

Activating

- ▶ Press button  (▷ page 197).

The indicator lamp on the button comes on.



The air recirculation mode is activated automatically at high outside temperatures.

The indicator lamp on the button  is not lit when the air recirculation mode is automatically switched on.

A quantity of outside air is added after approximately 30 minutes.

Warning!

Never operate the side windows if there is the possibility of anyone being harmed by the closing procedure.

In the event that the procedure causes potential danger, the closing of the side windows can be immediately halted by releasing the  button or by pressing or pulling the respective window switch.



If you press and hold button , the side windows will close.

Automatic climate control (CLK 500/CLK 55 AMG)

Deactivating

- ▶ Press button  (> page 197).

The indicator lamp on the button goes out.





The air recirculation mode is deactivated automatically:

- after 5 minutes if the outside temperature is below approximately 41°F (5°C)
- after 5 minutes if the air conditioning is turned off
- after 30 minutes if the outside temperature is above approximately 41°F (5°C)



If you press and hold button , the side windows will return to their previous position.

A side window will only return to its previous position if it has not been moved to another position using the respective side window switch after it was closed with button . A side window that was moved will remain in its current position if button  is used to re-open the remaining side windows.



Charcoal filter

An activated charcoal filter markedly reduces bad odors and removes pollutants from air entering the passenger compartment. The charcoal filter can be activated or deactivated.

The system switches automatically to the air recirculation mode, if the

- charcoal filter is switched on.
- carbon monoxide (CO) or nitrogen oxide (NO_x) concentration of the outside air increases beyond a predetermined level.



The automatic air recirculation mode does not function if the **A/C** (indicator lamp on button  or  not lit) mode is deactivated, or if the outside temperature has fallen below 41°F (5°C).

Automatic climate control (CLK 500/CLK 55 AMG)

Activating

- ▶ Press button  (▷ page 197).

The indicator lamp on the button comes on.



If you press and hold button , the side windows will close.



The activated charcoal filter should be switched off when windows fog up on the inside, or if the passenger compartment needs to be quickly heated or cooled down.

Warning!



Never operate the side windows if there is the possibility of anyone being harmed by the closing procedure.

In the event that the procedure causes potential danger, the closing of the side windows can be immediately halted by releasing the  button or by pressing or pulling the respective window switch.



Deactivating

- ▶ Press button  (▷ page 197).

The indicator lamp on the button goes out.



If you press and hold button , the side windows will return to their previous position.

A side window will only return to its previous position if it has not been moved to another position using the respective side window switch after it was closed with button . A side window that was moved will remain in its current position if button  is used to re-open the remaining side windows.

Automatic climate control (CLK 500/CLK 55 AMG)

Air conditioning

The cooling function, only operational when the engine is running, cools the vehicle interior down to the selected temperature. The cooling function also dehumidifies the air in the vehicle interior, thus preventing the windows from fogging up.



Condensation may drip out from underneath the vehicle. This is normal and not an indication of a malfunction.



Warning!



If you turn off the cooling function, the vehicle will not be cooled when weather conditions are warm. The windows can fog up more quickly. Window fogging may impair visibility and endanger you and others.

Deactivating

It is possible to deactivate the air conditioning (cooling) function of the automatic climate control system. The air in the vehicle will then no longer be cooled or dehumidified.

- ▶ Press button  or  (▷ page 197).

The indicator lamp on the button goes out.

The cooling function switches off after a short delay.

Activating

Moist air can fog up the windows. You can dehumidify the air with the air conditioning.

- ▶ Press button  or  (▷ page 197) again.

The indicator lamp on the button comes on.

The air conditioning uses the refrigerant R134a. This refrigerant is free of CFCs which are harmful to the ozone layer.



If the air conditioning cannot be turned on again, this indicates that the air conditioning is losing refrigerant. The compressor has turned itself off.

Have the air conditioning checked at the nearest authorized Mercedes-Benz Center.

Residual heat and ventilation* (Canada only)

With the engine switched off, it is possible to continue to heat or ventilate the interior for up to 30 minutes. This feature makes use of the residual heat produced by the engine.



How long the system will provide heating depends on

- the coolant temperature
- the temperature set by the operator

The blower will run at speed setting 1 regardless of the air distribution control setting.

Activating

- ▶ Switch off the ignition (▷ page 36).
- ▶ Press button  (▷ page 197).
The indicator lamp on the button comes on.

Deactivating

- ▶ Press button  (▷ page 197).

The indicator lamp on the button goes out.

The residual heat is automatically turned off:

- when the ignition is switched on
- after about 30 minutes
- if the battery voltage drops

Automatic climate control (CLK 500/CLK 55 AMG)

Rear passenger compartment adjustable air vents

The air conditioning for the rear passenger compartment is controlled via the automatic climate control panel (▷ page 197).



The temperature at the center air vents for the rear passenger compartment ② and ③ (▷ page 208) is the same as at the dashboard center air vents.

The air vents for the rear passenger compartment are located in the rear center console.

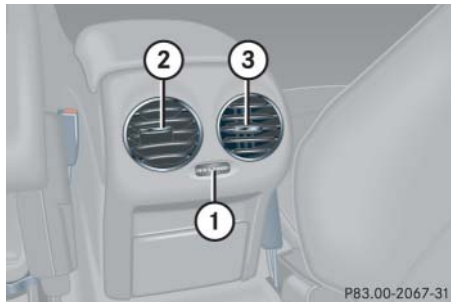

- ① Thumbwheel for air volume control for center air vents
- ② Left center air vent
- ③ Right center air vent

Adjusting air distribution

- ▶ Push the slide for the left center vent ② or right center vent ③ to the left, right, up or down.

The air flow is directed in the corresponding direction.



For draft-free ventilation, push slides ② and ③ upward.

Adjusting air volume

- ▶ Turn thumbwheel ① to the left or right.
The air volume is increased or decreased.

▼ Audio system

Audio and telephone*, operation

These instructions are intended to help you become familiar with your Mercedes-Benz audio system. They contain useful tips and a detailed description of the user functions.

Warning!



In order to avoid distraction which could lead to an accident, the driver should enter system settings with the vehicle at a standstill and operate the system only when road and traffic conditions permit. Always pay full attention to traffic conditions first before operating system controls while driving.

Bear in mind that at a speed of just 30 mph (approximately 50 km/h), your car is covering a distance of 44 feet (approximately 14 m) every second.

Operating safety

Warning!



Any alterations made to electronic components can cause malfunctions.

The radio, amplifier, CD changer*, satellite radio*, and telephone* are interconnected. When one of the components is not operational or has not been removed/replaced properly, the function of other components may be impaired.

This condition might seriously impair the operating safety of your vehicle.

We recommend that you have any service work on electronic components carried out by an authorized Mercedes-Benz Center.

Sound system*

Your vehicle is equipped with a sound system. The subwoofer is located between the rear seats.

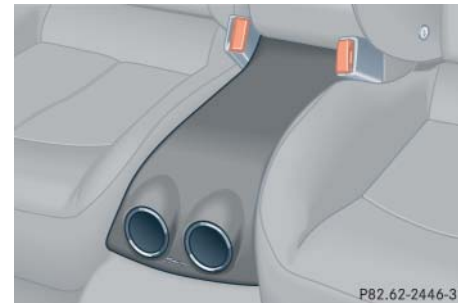

Make sure no objects fall into the openings of the subwoofer between the rear seats.

If necessary, contact an authorized Mercedes-Benz Center to remove any objects which may have fallen into the openings.

Operating and display elements

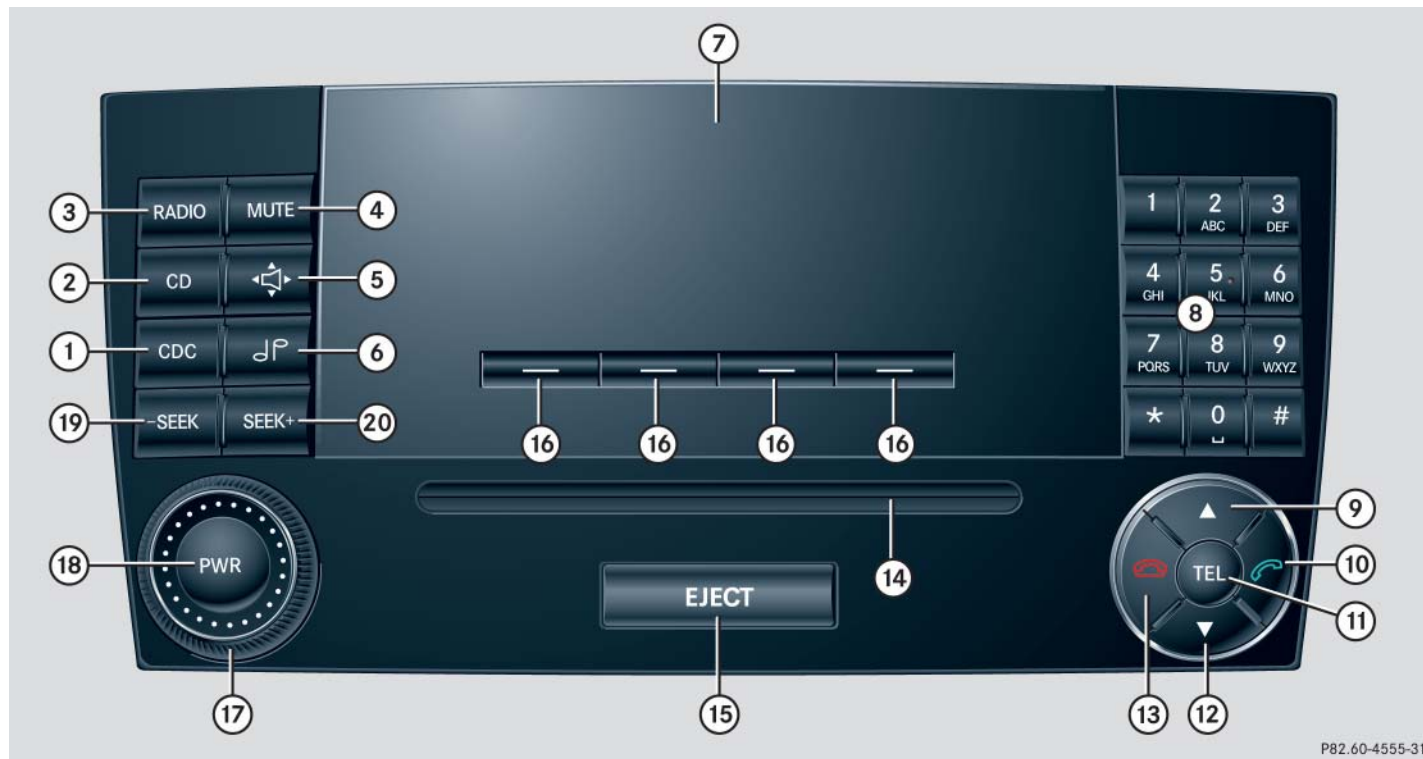

P82.60-4555-31

Item	Page
① CD changer mode selector	227
AUX mode selector	216
② Single CD mode selector	228
③ Radio mode selector	
④ Mute function (radio)	220
Pause (CD)	233
⑤ Volume distribution	215
⑥ Sound settings	213
⑦ Display	
⑧ Alphanumeric keypad	

Item	Page
⑨ Speed dialing memory (telephone) in descending order	
⑩ Accepting a call (telephone)	238
⑪ Telephone mode selector	233
⑫ Speed dialing memory (telephone) in ascending order	235
⑬ Terminating a call (telephone)	239
⑭ CD slot	
⑮ CD ejection	229

Item	Page
⑯ Soft keys	212
⑰ Volume	213
⑱ Switching on/off	212
⑲ Manual tuning / seek tuning (radio)	218
Track search, reverse (CD)	232
⑳ Manual tuning / seek tuning (radio)	218
Track search, fast forward (CD)	232

Audio system

Button and soft key operation

In these instructions, the alphanumeric keypad (right side of radio panel) and the function buttons (left side of radio panel) are referred to as “buttons”. The four keys below the display panel are referred to as “soft keys”.



Do not press directly in the display face. Otherwise, the display will be damaged.

Operation

Switching the unit on/off

Switching on

- ▶ Turn the SmartKey in the starter switch to position **1** or **2**.
- ▶ If the audio system was on as you removed the SmartKey from the starter switch, the audio system will automatically come back on as you turn the SmartKey to position **1** or **2**.

or

- ▶ Press  button.



If the radio is switched on without the key in the starter switch, it will automatically switch off again after approx. 30 minutes.

If your vehicle is equipped with a telephone, the display may prompt you to enter your PIN (GSM network) or code (TDMA or CDMA network).

Switching off

- ▶ Remove SmartKey from starter switch.

or

- ▶ Press  button.



Should excessively high temperatures occur while the audio system is being operated, the display will dim. If temperatures continue to rise, **HIGH TEMP** will appear in the display, after which the audio system will be switched off for a cooling-down period.

Adjusting the volume

- ▶ Turn rotary control of  button.
The volume will increase or decrease depending on the direction turned.



If your vehicle equipment includes a Mercedes-Benz specified mobile telephone*, you can adjust its volume separately from the volume of the audio system while the telephone is being used.

Adjusting sound functions

The bass and treble functions are called up by pressing the  button.

Settings for bass and treble are stored separately for the AM and FM wavebands, weather band, CD mode and telephone mode.

Bass

- ▶ Press  button repeatedly until BASS appears in the display.



- ▶ Press + or - soft key to increase or decrease tone level accordingly.

or

- ▶ Press RES soft key briefly to reset bass tones to their center level.

The radio switches back to the standard radio menu eight seconds after the last soft key is pressed.

Adjusting treble

- ▶ Press  button repeatedly until TREBLE appears in the display.



- ▶ Press + or - soft key to increase or decrease tone level accordingly.

or

- ▶ Press RES soft key briefly to reset treble tones to their center level.

The radio switches back to the standard radio menu eight seconds after the last soft key is pressed.

Audio system

Sound system*

You can either program the sound settings manually (▷ page 213) or choose settings via preset sound characteristics.

You can select from among the following settings:

- **STANDARD:** conventional stereo sound.
 - **SURROUND:** the sound is set for better three-dimensional acoustic characteristics.
 - **SPEECH:** the sound is optimized for the spoken word.
- ▶ Press **⏮** button repeatedly until **STANDARD**, **SURROUND** or **SPEECH** appears in the display.
- ▶ Press **<<<** or **>>>** soft key repeatedly until the desired sound setting has been reached.

The sound is set accordingly.

or

- ▶ Press **RES** soft key briefly.

The sound setting is reset depending on the sound source activated.

- **Radio mode:** **STANDARD**
- **CD/AUX mode:** **SURROUND**
- **Telephone:** **SPEECH**

The radio switches back to the standard radio menu eight seconds after the last soft key is pressed.

Returning sound functions to factory settings

- ▶ Press **⏮** button to call up settings menu in the display.



- ▶ Press **RES** soft key briefly; the respective sound function is reset to its center level.

or

- ▶ Press and hold **RES** soft key until **RESET** appears in the display.

The sound settings for bass and treble are returned to their center level and the volume is set to a predefined level.

Vehicles with sound system*:

The sound setting is reset depending on the sound source activated.

- **Radio mode:** **STANDARD**
- **CD/AUX mode:** **SURROUND**
- **Telephone:** **SPEECH**

The radio switches back to the standard radio menu four seconds after the last soft key is pressed.



Adjusting volume distribution

Call up fader and balance functions by pressing the  button.

Fader

- ▶ Press  button repeatedly until FADER appears in the display.



- ▶ Press  or  soft key.

The volume is distributed accordingly between the front and rear of the vehicle.

or

- ▶ Press RES soft key briefly.



The fader is reset to its center level.

The radio switches back to the standard radio menu eight seconds after the last soft key is pressed.

Adjusting balance

- ▶ Press  button repeatedly until BALANCE appears in the display.



- ▶ Press  or  soft key.

The volume is distributed between the left and right sides of the vehicle.

or

- ▶ Press RES soft key briefly.

The balance is reset to its center level.

The radio switches back to the standard radio menu eight seconds after the last button is pressed.

Audio system

Returning volume distribution to factory settings

- ▶ Press  button to call up settings menu in the display.



- ▶ Press RES soft key briefly; the respective volume distribution is reset to its center (flat) level.

or

- ▶ Press and hold RES soft key until RESET appears in the display.

The volume distribution settings for fader and balance are set to their center level.

The radio switches back to the standard radio menu four seconds after the last soft key is pressed.

Telephone* muting

If your vehicle equipment includes a Mercedes-Benz specified mobile telephone*, you can adjust its volume separately from the volume of the audio system while the telephone is being used.

Connecting an external audio source (AUX) to the radio*

An optional dealer-installed cinch-connector* for connecting an external audio source may become available for your vehicle model. Feature description is based on preliminary information at time of printing. Contact an authorized Mercedes-Benz Center for availability.

You can adjust the volume (▷ page 213), the sound settings (▷ page 213) and the volume distribution (▷ page 215) for the AUX input.

Calling up AUX mode

- ▶ Press and hold  button until AUX appears in the display.

Canceling AUX mode

- ▶ Press any audio source button.

Radio operation

Selecting radio mode

- ▶ Press **RADIO** button.

Calling up wavebands

You can choose from among the FM, AM and WB wavebands.

Weather band (▷ page 221).



FM waveband: 87.7.....107.9 MHz

AM waveband: 530.....1710 kHz

*Calling up wavebands for radios without SAT**

- ▶ Press FM or AM soft key to switch between FM and AM.

The FM and AM wavebands are called up one after another.

or

- ▶ Press WB soft key.

The weather band menu is called up.

The waveband currently selected appears in the upper left-hand corner of the display.

*Calling up wavebands for radios with SAT**

- ▶ Press FM, AM or WB soft key repeatedly until desired waveband has been selected.

The FM, AM and WB wavebands are called up one after another.

The waveband currently selected appears in the upper left-hand corner of the display.

Audio system

Selecting a station

The following options are available for selecting a station:

- Direct frequency input (▷ page 218)
- Manual tuning (▷ page 218)
- Automatic seek tuning (▷ page 219)
- Scan search (▷ page 219)
- Station memory (▷ page 219)
- Automatic station memory (Autostore) (▷ page 220)

The station search proceeds in the following frequency increments:

- 200 kHz in FM range
- 10 kHz in AM range

Direct frequency input

- ▶ Select desired waveband.



- ▶ Press ***** button.
- ▶ Enter desired frequency with buttons **1** to **0**.



You can only enter frequencies within the respective waveband.

If a button is not pressed within four seconds, the radio will return to the last station tuned.

Manual tuning

- ▶ Select desired waveband.
- ▶ Press **SEEK+** or **-SEEK** button for approx. three seconds.
- ▶ Press button repeatedly until desired frequency has been reached.

Step-by-step station tuning takes place in ascending or descending order. Each time the button is pressed, the radio tunes further by 0.2 MHz. During manual tuning, the radio is muted.

Automatic seek tuning

- ▶ Select desired waveband.
- ▶ Press **SEEK+** or **-SEEK** button briefly.

The radio will tune to the next highest or next lowest receivable frequency.



If no station is received after two consecutive scans of the complete frequency range, then the scan stops at the frequency from which it began.

Scan search

- Starting scan search
 - ▶ Select desired waveband.



- ▶ Press **SC** soft key.

SC will appear in the display. The radio briefly tunes in all receivable stations on the waveband selected.
- Ending scan search
 - ▶ Press **SC** soft key or **SEEK+** or **-SEEK**.

The station last played will be selected and **SC** disappears from the display.

Station memory

You can store ten AM and ten FM stations in the memory.

- Storing stations
 - ▶ Tune in desired station.
 - ▶ Press and hold desired station button **1** to **0** until a brief signal tone is heard.

The frequency is stored on the selected station button.
- Calling up stations
 - ▶ Press desired station button **1** to **0** briefly.

Audio system

Autostore – automatic station memory

The Autostore memory function provides an additional memory level. The station memory for manually stored stations is not overwritten.

- Calling up Autostore memory level and storing stations

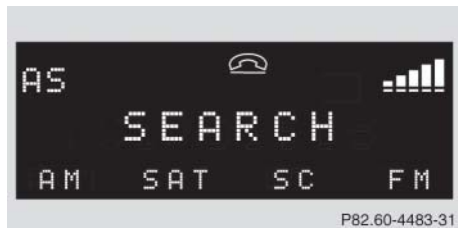

- ▶ Press AS soft key briefly.

The radio switches to the Autostore memory level. AS and SEARCH appear in the display and the radio finds the ten stations with the strongest signals. These stations are stored on the station buttons **1** to **0** in order of signal strength.

- Calling up stations
 - ▶ Press desired station button **1** to **0**.
- Leaving the Autostore memory level
 - ▶ Press FM or AM soft key briefly.

Interrupting radio mode

The radio mode is interrupted by an incoming call on the telephone* (▷ page 238).

- Mute on
 - ▶ Press **MUTE** button.
The radio mode is interrupted and MUTED appears in the display.
- Mute off
 - ▶ Press **MUTE** button.
The radio mode is again active.

Weather band



- ▶ Press WB soft key.

The weather band station last received is tuned in.

Selecting a weather band station directly

- ▶ Select desired weather band station with buttons **1** to **7** PRESET.

If a station cannot be tuned in, a search is automatically started.

Search

- ▶ Press **SEEK+** or **-SEEK** button to tune in the next receivable weather band station.



If no weather band station is received after three consecutive scans of the complete frequency range, then the scan stops at the channel with which it began and NO WB FOUND appears in the display.

If this happens, switch back to standard radio mode.

Scan search

- Starting scan search
 - ▶ Press SC soft key.

SC will appear in the display. The radio briefly tunes in all receivable weather band stations.
- Ending scan search
 - ▶ Press SC soft key or **SEEK+** or **-SEEK**.

The weather band station last played will be selected and SC disappears from the display.

Audio system

Introduction to satellite radio* (USA only)

SIRIUS satellite radio provides 100 channels of digital-quality radio, among others music, sports, news, and entertainment, free of commercials. SIRIUS satellite radio uses a fleet of high-power satellites to broadcast 24 hours per day, coast to coast, in the contiguous U.S.

This diverse, satellite-delivered programming is available for a monthly subscription fee.

For more information and service availability call the SIRIUS Service Center (▷ page 226), or contact www.siriusradio.com



Additional satellite radio equipment and a subscription to a satellite radio service provider are required for the satellite radio operation described here.

Contact an authorized Mercedes-Benz Center for details and availability for your vehicle.

Note that categories and channels shown in illustrations are dependent on programming content delivered by the service provider. Programming content is subject to change. Therefore, channels and categories shown in illustrations and descriptions contained in this manual may differ from the channels and categories delivered by the service provider.



Satellite radio service may be unavailable or interrupted from time to time for a variety of reasons, such as environmental or topographic conditions and other things beyond the service provider's or our control. Service might also not be available in certain places (e.g., in tunnels, parking garages, or within or next to buildings) or near other technologies.

Program categories

The channels are categorized. Categories allow you to tune to stations broadcasting a certain type of program (category mode) (▷ page 225).

Calling up the SAT main menu

- ▶ Press SAT soft key.

SAT is displayed in the upper left-hand corner of the display.

Prior to activation of the satellite radio service (▷ page 223).

After activation of satellite radio service (▷ page 223).

Prior to activation of the satellite radio service



The telephone number of the SIRIUS Service Center (888-539-7474) is displayed.

- ▶ Press ESN soft key.

The twelve-digit electronic serial number (ESN) of the SAT tuner* installed in your vehicle is displayed.

This information is required to call the SIRIUS Service Center for an activation request.



Credit card information may also be required for your application.

The activation process takes approximately five to ten minutes after calling the SIRIUS Service Center.

After activation of the satellite radio service

The satellite radio main menu appears. The radio station selected last is audible, provided it can be received.



The system will tune to a default station if no station had been selected previously.



The first channel 001 is called up and the PTY system changes to All categories.

If no station can be received, ACQUIRING appears in the display.

If the Satellite radio service is not activated, ACQUIRING will also appear in the radio display and NO SAT will appear in the multifunction display.

Audio system

Selecting a station

The following options are available:

- Selecting a station using the selected category (▷ page 225).
- Tuning via station presets (▷ page 224).
- Tuning via scan search (▷ page 225).
- Tuning via manual channel input (▷ page 224).
- Tuning via the program category list (▷ page 225).

Tuning via station presets

Ten satellite radio station presets are available.

You can access the presets via number keys.

Accessing via number keys

- ▶ Enter number of preset you wish to select, e.g. **1**.

The radio plays the station stored under this number and the PTY function changes to the category corresponding to the station.

Tuning via manual channel input



Example: tuning in channel 16

- ▶ Press *****.

Input line appears in the main radio menu.

- ▶ Use number keys to enter desired channel within eight seconds, e.g. **1** **6**.

The system tunes to channel 16.

The station you have selected begins to play.



You can only enter available channel numbers.

Tuning via the program category list

The category list contains all currently receivable categories of programs. It is arranged alphabetically.

- Selecting a category
 - ▶ Press **PTY** soft key.



The current **PTY** category of the station is displayed.

- ▶ Press **<<<** or **>>>** soft key.

This switches between the individual categories.

When changing the category, the channel selected last in the new category becomes audible.

The system will automatically switch to a station of the selected category if the currently selected station is not of the selected category. Otherwise, the currently selected station remains tuned.

- Tuning a station within the selected category

The channels identified for the currently selected category are arranged numerically. Only one entry is visible at a time.

- ▶ Press **SEEK+** or **-SEEK** button briefly.

The next station within the category is started.

or

- ▶ Press and hold **SEEK+** or **-SEEK** button for approx. three seconds until desired station has been reached.

Tuning via scan search

Scan search is characterized as follows:

- Scan search plays a channel for approx. eight seconds and then skips to the next channel within the current category.
- Scan search can be terminated manually.

- ▶ Press **SC** soft key.

The search starts. **SC** appears in the display.

- ▶ Press **SC** soft key again.

The search stops.

Audio system

Obtaining additional text information

Additional text information (artist, title) related to the current channel can be displayed.

- ▶ Press INF soft key.

The title being played is displayed.

- ▶ Press INF soft key again.

The name of the artist performing the title being played is displayed.



If a button is not pressed within four seconds, the radio will return to the standard display.

Storing stations

- ▶ Tune in desired station.
- ▶ Press and hold desired station button **1** to **0** until a brief signal tone is heard.

The frequency is stored on the selected station button.

The radio saves the current station at the memory preset selected. The memory preset selected appears in the status line, e.g. S3.



There are ten presets available.

An existing entry is overwritten in the memory list when a new entry is given.

Calling up the ESN information menu

- ▶ Press INF soft key.
- ▶ Press ESN soft key.

The twelve-digit electronic serial number (ESN) of the SAT tuner* installed in your vehicle is displayed.

- ▶ Press RET soft key to exit the menu.

CD mode

Safety precautions

Warning!



The single CD player and the CD changer* are Class 1 laser products. There is a danger of invisible laser radiation if the housing is opened or damaged.

Do not open the housing. The single CD player and the CD changer* do not contain any parts that can be serviced by the user. For safety reasons, have any service work which may be necessary performed only by qualified personnel.

Warning!



In order to avoid distraction which could lead to an accident, the driver should insert CDs with the vehicle at a standstill and operate the audio system only if permitted by road, weather and traffic conditions.

Bear in mind that at a speed of just 30 mph (approximately 50 km/h), your car covers a distance of 44 feet (approximately 14 m) every second.

General notes

The system may not be able to play audio CDs with copy protection.

Playing copied CDs may cause malfunctions during playback.



If you affix stickers to the CDs, they can become warped due to the heat that develops in the CD drive or CD changer*.

In certain situations, the CDs can then no longer be ejected and cause damage to the drive. Such damage is not covered by the Mercedes-Benz Limited Warranty.



Your CD drive or CD changer* has been designed to play CDs which correspond to the EN 60908 standard. You can therefore only use CDs with a maximum thickness of 1.3 mm.

If you insert thicker data carriers, e.g. ones that have data on both sides (one side with DVD data, the other side with audio data), they cannot be ejected and will damage the drive.

Audio system

Do not use CDs with an eight cm diameter, not even with a CD adapter. Attempting to play CDs with an eight cm diameter or playing such CDs with an adapter may cause damage to the CD drive. Such damage is not covered by the Mercedes-Benz Limited Warranty.

Should excessively high or low temperatures occur while in CD changer mode*, CD TEMP will appear in the display, and the CD will be muted until the temperature has reached an acceptable level for the system to continue operation.

The single CD player and the CD changer* play audio CDs.

Tips on handling CDs

- Handle CDs carefully to prevent interference during playback.
- Avoid scratches, fingerprints and dust on the CDs.
- Do not write on CDs or apply any labels or other material to them.

- Clean CDs from time to time with a commercially available cleaning cloth. Never wipe the CD in a circular motion; instead, wipe it in a straight line starting in the center and moving outward. Do not use solvents, anti-static sprays, etc. for cleaning.
- Replace the CD in its case after use.
- Protect CDs from heat and direct sunlight.

Operating the single CD player in the audio system unit

Loading a CD

The single CD player in the audio system unit has capacity for one CD. The CD slot for loading the drive is located underneath the soft keys.

- ▶ Make sure the system is switched on.
- ▶ Insert CD into CD slot. The label side of the CD must face upwards.

The system automatically pulls the CD into the CD slot. The audio CD begins to play.



If a CD is already loaded, it must be ejected before inserting a new CD. Inserting a second CD in the slot with another CD still loaded will cause damage to the CD drive not covered by the Mercedes-Benz Limited Warranty.



If a CD has been inserted incorrectly or cannot be read, WRONG CDO will appear in the display.

Ejecting a CD

- ▶ Make sure the system is switched on.
- ▶ Press **EJECT** button.

The system ejects the CD. NO CD will appear in the display.

- ▶ Remove CD from slot.



If you do not take the CD out of the CD slot within approx. 15 seconds, the system automatically pulls the CD back in and plays it.

If a CD is pulled back in, press **EJECT** button for five seconds; the CD will then be ejected.

Operational readiness of CD changer*

If a CD changer has been installed in the vehicle, it can be operated from the front control panel of the audio system. A loaded magazine must be installed to play CDs.

The CD changer is located in the glove box.

Loading/unloading the CD magazine



The CD changer* may not be able to play audio CDs with copy protection.

- ▶ Slide changer door to the right and press button.
- ▶ Magazine will be ejected.

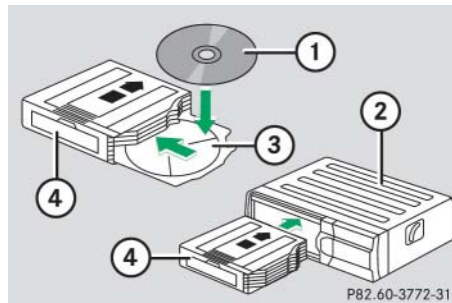

- ① CD
- ② CD changer
- ③ CD tray
- ④ CD magazine

- ▶ Remove magazine ④ and pull CD tray ③ fully out.

- ▶ Place CD ① in recess of tray, label side up.
- ▶ Push tray into magazine in direction of arrow.



CDs which have been inserted improperly or are unreadable will not be played.

- ▶ Push magazine into CD changer ② in direction of arrow and close sliding door.

Audio system

Playing CDs

Single CD player in the audio unit

- ▶ Press **CD** button.

CD 0 will appear in the upper left-hand corner of the display.

The CD will resume playback at the point where it was switched off.

*CD changer**

- ▶ Press **CD** button.

CD and the selected magazine slot number appear in the upper left-hand corner of the display.

If you have not removed a CD since the last time the CD audio source was activated, the last CD listened to will begin to play at the point where it was switched off.

After the last track on a CD has finished, the next CD is automatically played.

Playing tracks

You have the following options:

- Audio system with CD changer*: selecting CDs
- Direct track entry
- Track skip forward/reverse
- Fast forward/reverse
- Scan
- Random tracks
- Repeat track

Selecting CDs in the audio unit with CD changer*

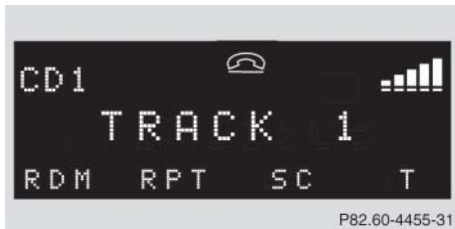

P82.60-4455-31

- ▶ You can select from among the inserted CDs with buttons

0 to **6**.

0 = CD player in the audio unit

1 to **6** = CDs in the

CD changer*

The magazine slot number of the selected CD appears next to **CD** in the display, and the number of the currently played track appears next to **TRACK**.



If there is no CD in the selected magazine slot, **NO CD** appears in the display with the corresponding slot number.

Direct track entry



P82.60-4456-31

You can make a direct selection from among the tracks on a CD.

- ▶ Press ***** button.
- ▶ Enter track number using buttons **1** to **0**.

The number of the track being played appears next to **TRACK** in the display.

You can only enter available track numbers.

Skipping tracks forward/backward

- Skipping tracks forward
 - ▶ Press **SEEK+** button briefly. The next track will be played.
- Skipping tracks backward
 - ▶ Press **SEEK-** button briefly.

If the track has been playing for more than ten seconds, the unit skips back to the beginning of the track currently playing. If less than ten seconds have been played, the unit skips back to the beginning of the previous track.

Pressing the **SEEK-** or **SEEK+** button repeatedly will result in multiple tracks being skipped.

Audio system

Fast forward/reverse

- Fast forward
 - ▶ Press and hold **SEEK+** button until desired point has been reached.
- Reverse
 - ▶ Press and hold **-SEEK** button until desired point has been reached.



The track number and the relative time of the track is shown in the display during the search.

Scan

- Starting scan
 - ▶ Press **SC** soft key.
SC will appear in the display.
Each track on the current CD will be played for approx. eight seconds in ascending order.
- Ending scan
 - ▶ Press **SC** soft key or **-SEEK** or **SEEK+**.

Random play

The random function (RDM) plays the tracks of the current CD in random order.



When you start the RDM function, the RPT function is automatically switched off.

- Switching on random
 - ▶ Press **RDM** soft key.
RDM appears in the display. A randomly selected track is played.
- Switching off random
 - ▶ Press **RDM** soft key again.

Repeat

The track being played is repeated until the repeat function is switched off.



When you start the RPT function, the RDM function is automatically switched off.

- Switching on repeat
 - ▶ Press **RPT** soft key.
RPT appears in the display.
- Switching off repeat
 - ▶ Press **RPT** soft key again.

Pause function

The CD changer* mode is interrupted by an incoming call on the telephone* (▷ page 238).

- Switching on pause function



- ▶ Press **MUTE** button.

The CD changer* mode is interrupted and **PAUSE** appears in the display.

- Switching off pause function

- ▶ Press **MUTE** button.

The CD changer* mode is active again.

Track and time display



- ▶ Press **T** soft key.

The number of the track being played and the elapsed playing time appear in the display.

- ▶ Press **T** soft key again.

The total number of tracks and the total playing time of the CD appear in the display.

- ▶ Press **T** soft key.

The standard CD playback menu appears in the display.

GSM network phones

Warning!



Please do not forget that your primary responsibility is to drive the vehicle. A driver's attention to the road must always be his/her primary focus when driving. For your safety and the safety of others, we recommend that you pull over to a safe location and stop before placing or taking a telephone call.

If you choose to use the telephone¹ while driving, please use the hands-free device and only use the telephone when road, weather and traffic conditions permit. Some jurisdictions prohibit the driver from using a cellular telephone while driving a vehicle.

Bear in mind that at a speed of just 30 mph (approximately 50 km/h), your vehicle is covering a distance of 44 feet (approximately 14 m) every second.

¹ Observe all legal requirements.

Audio system

Using your Mercedes-Benz specified mobile telephone*, a number of functions and operating steps can be performed and displayed in the audio system display.

Further operating instructions not covered here can be found in the operating instructions for the multifunction steering wheel and the cellular telephone*.

If your audio system is set up for telephone operation, the  symbol will appear in the display.

When you insert your Mercedes-Benz specified mobile telephone* into the telephone cradle, you will be prompted to enter your PIN for 30 seconds (▷ page 234). This display disappears when you press any button.

When your mobile telephone is inserted into the telephone cradle, you will see the reception strength in the upper right-hand corner of the display.

Switching on the telephone

Switching on the telephone

- ▶ Press **TEL** button.

If the telephone was previously switched off, **PROCESSING** appears in the display and you will then be prompted to enter your PIN.

Switching off the telephone

- ▶ Press **TEL** button for approx. three seconds.

PROCESSING appears in the display until the telephone is off. Afterward, **PHONE OFF** appears in the display.

PIN entry



- ▶ Enter PIN number using buttons **1** to **0**.
- ▶ If necessary, correct number entered with the CLR soft key. Press soft key briefly to delete the last digit entered; press soft key and hold to delete the complete number.
- ▶ Press **OK** soft key after entering correct PIN.
- ▶ **READY** or **ROAMING** will appear in the display.



If the PIN is entered incorrectly three times, **NEED PUK** will appear in the display. Enter PUK via your telephone. Please refer to the separate telephone operating instructions for more information.

Adjusting the volume

- ▶ Turn rotary control of  button during a telephone call.

The volume will increase or decrease depending on the direction turned.



The volume can be adjusted separately for telephone mode and audio mode.



Adjusting sound

- ▶ Adjust sound during a telephone call. Sound adjustment (▷ page 213).

Placing a call

Entering a telephone number and starting the dialing process



- ▶ Enter desired telephone number using buttons  to .

The number can have up to 32 digits, but only twelve of these are visible in the display.

- ▶ If necessary, correct number entered with the **CLR** soft key. Press soft key briefly to delete the last digit entered; press soft key and hold to delete the complete number.
- ▶ After correct telephone number has been entered, press  button.



If the telephone number has been saved together with a name in the telephone book, the name will appear in the display.

Phone book

The numbers stored in the phone book of the telephone can be called up either by name or number.

In addition, incoming calls are stored in the phone book.

Audio system



This is only possible, however, when the call information transmitted includes the number of the person calling. If the telephone number is not transmitted, NO NUMBER will be stored in the phone book.

- Searching and calling up telephone book entries by name

You can access your mobile telephone's phone book using the audio system. You can access both the main entries and the sub-entries of your phone book.



▶ Press MEM soft key or press or .

▶ Press desired numerical key to .

The stored entries are selected according to the alphabetical order of the initial letters (e.g. for S-Smith, press button four times).

or

▶ Press and hold button or .

The system jumps from one initial letter to the next in ascending or descending order.

▶ Press and hold button or until desired initial letter has been reached.

or

▶ Press button or repeatedly until desired entry has been reached.

The stored entries are selected in alphabetical order with the sub-entries.

















Several sub-entries can be stored for each main entry (name). These entries are marked by a corresponding abbreviation that appears in the upper left-hand corner of the display. The following abbreviations for sub-entries are possible:

CEL = Mobile phone
HOM = Home
WOR = Work
FAX = Fax
PAG = Pager
TEL = Main

- ▶ When you have selected a number, press  button.
The call will be made.
- Viewing the telephone number of a telephone book entry
 - ▶ Search for desired entry.
 - ▶ Press NUM soft key.
The telephone number of the phone book entry appears in the display.
- Returning calls received



- ▶ Press MEM soft key or press  or .
- ▶ Press RCV soft key (received calls).
The number of received calls and then the call last received appear briefly in the display.
- ▶ Select desired telephone number with button  or .
- ▶ When you have selected a number, press  button.
The call will be made.

- Speed dial
 - If you have stored telephone numbers as speed dial numbers in your telephone, you can also enter these with buttons  to  on the radio head unit.
 - ▶ Press desired button  to  briefly.
 - ▶ Press  button.
The call will be made.
- Turbo dial
 - If you have stored telephone numbers as turbo dial numbers in your telephone, you can also enter these with buttons  to  on the radio head unit.
 - ▶ Press desired button  to  until the call is made.

Audio system

Redial

If the number you have dialed is busy, you can again place calls to the last ten telephone numbers dialed using the redial function.



If you have activated the automatic redial function on your telephone, the number of the person being called is automatically redialed after a short waiting period if there is a busy signal. Refer to the separate operating instructions for the mobile telephone.

- Manual redial



- ▶ Press button.

The telephone number last dialed will appear in the display.

- ▶ Select desired telephone number with button or .

The letter L and the number of the memory position appears in the left-hand corner of the display. The numbers are stored in the order of the calls made.

- ▶ When you have selected a number, press button.

The call will be made.

Accepting an incoming call

If the telephone is active in the background (reception symbol is visible in the display), the audio source is muted when an incoming call is received. A ringing tone can be heard and the caller's telephone number, or the name under which the telephone number has been saved in the phone book, appears in the display. If the caller's number is not transmitted with the call, CALL will appear in the display.

- ▶ Press button.

The call is accepted.

Muting a call

It is possible to mute a call; the caller is then no longer able to hear you.

- Mute on
 - ▶ Press MUT soft key.
 - ▶ MIC MUTE will appear in the display.
- Mute off
 - ▶ Press MUT soft key again.

Terminating a call

- ▶ Press  button.

The current call is terminated and the muted audio source becomes active again.

Talking with two callers at the same time

If you wish to receive or place another call during an already active call, you can accept or place the second call and switch between the callers or combine them into one call. Note that the features described here are depending on availability from your mobile phone service provider.

- Placing/accepting a second call
 - ▶ Place new call by entering telephone number manually.
 - ▶ Press  button.
You are connected to the second caller; the first caller is kept on hold.



or

- ▶ Press  button to accept a second call.







You will be notified of the second call acoustically, but you will not see this in the display.

You are connected with the second caller; the first caller is kept on hold.

- Switching between calls
 - ▶ Press  and  buttons.
This switches between the calls. The non-active call is kept on hold.

Audio system

- Terminating a call
 - ▶ Press  button.
The current call is terminated. You are again connected with the caller previously placed on hold.
- Combining two calls
 - ▶ Press  and  buttons.
The calls are combined into one call.
- Terminating a combined call
 - ▶ Press  button.
The connection to both callers is terminated.

TDMA or CDMA network phones

Warning!



Please do not forget that your primary responsibility is to drive the vehicle. A driver's attention to the road must always be his /her primary focus when driving. For your safety and the safety of others, we recommend that you pull over to a safe location and stop before placing or taking a telephone call.

If you choose to use the telephone¹ while driving, please use the hands-free device and only use the telephone when road, weather and traffic conditions permit. Some jurisdictions prohibit the driver from using a cellular telephone while driving a vehicle.

Bear in mind that at a speed of just 30 mph (approximately 50 km/h), your vehicle is covering a distance of 44 feet (approximately 14 m) every second.

¹ Observe all legal requirements.

Using your Mercedes-Benz specified mobile telephone*, a number of functions and operating steps can be performed and displayed in the audio system display.

Further operating instructions not covered here can be found in the operating instructions for the multifunction steering wheel and the mobile telephone*.

If your audio system is set up for telephone operation, the  symbol will appear in the display.

When you insert your Mercedes-Benz specified mobile telephone* into the telephone cradle, you will be prompted to enter your PIN for 30 seconds (> page 241). This display disappears when you press any button.

When your mobile telephone is inserted into the telephone cradle, you will see the reception strength in the upper right-hand corner of the display.

Switching on the telephone

Switching on the telephone

- ▶ Press **TEL** button.

If you have programmed an unlock code for the telephone, you must now enter the code.



- ▶ Enter code using buttons **1** to **0**.
- ▶ If necessary, correct number entered with the CLR soft key. Press soft key briefly to delete the last digit entered; press soft key and hold to delete the complete number.

- ▶ Press OK soft key after entering correct code.

The telephone is unlocked. If you have entered an incorrect code, you must enter the correct code.

Switching off the telephone

- ▶ Press **TEL** button for approx. three seconds.

PROCESSING appears in the display until the telephone is off. Afterward, PHONE OFF appears in the display.

Adjusting the volume

- ▶ Turn rotary control of  button during a telephone call.

The volume will increase or decrease depending on the direction turned.



The volume can be adjusted separately for telephone mode and audio mode.

Adjusting sound

- ▶ Adjust sound during a telephone call. Sound adjustment (▷ page 213).

Placing a call

Entering a telephone number and starting the dialing process



- ▶ Enter desired telephone number using buttons **1** to **0**.

The number can have up to 32 digits, but only twelve of these are visible in the display.



Audio system

- ▷▷ If necessary, correct number entered with the CLR soft key. Press soft key briefly to delete the last digit entered; press soft key and hold to delete the complete number.
- ▶ After correct telephone number has been entered, press  button.



If the telephone number has been saved together with a name in the phone book, the name will appear in the display.

Phone book

The numbers stored in the phone book of the mobile telephone can be called up either by name or number.

In addition, incoming calls are stored in the phone book.





This is only possible, however, when the call information transmitted includes the number of the person calling. If the telephone number is not transmitted, NO NUMBER will be stored in the phone book.

- Searching and calling up phone book entries by name.

You can access your mobile telephone's phone book with the audio system. You can access both the main entries and the sub-entries of your phone book.





- ▶ Press MEM soft key or press  or .



- ▶ Press desired numerical key  to .

The stored entries are selected according to the alphabetical order of the initial letters (e.g. for S-Smith, press button  four times).

or

- ▶ Press and hold button  or .

The system jumps from one initial letter to the next in ascending or descending order.

- ▶ Press and hold button  or  until desired initial letter has been reached.

or

- ▶ Press button **▲** or **▼** repeatedly until desired entry has been reached.

The stored entries are selected in alphabetical order with the sub-entries.



Several sub-entries can be stored for each main entry (name). These entries are marked by a corresponding abbreviation that appears in the upper left-hand corner of the display. The following abbreviations for sub-entries are possible:

CEL = Mobile phone
 HOM = Home
 WOR = Work
 FAX = Fax
 PAG = Pager
 TEL = Main

- ▶ When you have selected a number, press **☎** button.

The call will be made.

- Viewing the telephone number of a phone book entry

- ▶ Search for desired entry.

- ▶ Press NUM soft key.

The telephone number of the phone book entry appears in the display.

- Returning calls received



- ▶ Press MEM soft key or press **▲** or **▼**.

- ▶ Press RCV soft key (received calls).

The number of received calls and then the call last received appear briefly in the display.

- ▶ Select desired telephone number with button **▲** or **▼**.

The letter R and the number of the memory position appear in the upper left-hand corner of the display. The numbers are stored in the order of the calls received.

- ▶ When you have selected a number, press **☎** button.

The call will be made.

Audio system

- Speed dial

If you have stored telephone numbers as speed dial numbers in your telephone, you can also enter these with buttons **1** to **0** on the radio unit.

- ▶ Press desired button **1** to **0** briefly.
- ▶ Press  button.

The call will be made.

- Turbo dial

If you have stored telephone numbers as turbo dial numbers in your telephone, you can also enter these with buttons **1** to **0** on the radio unit.

- ▶ Press desired button **1** to **0** until the call is made.

Redial

If the number you have dialed is busy, you can again place calls to the last ten telephone numbers dialed using the redial function.





If you have activated the automatic redial function on your mobile telephone, the number of the person being called is automatically redialed after a short waiting period if there is a busy signal. Refer to the separate operating instructions for the mobile telephone.

- Manual redial

- ▶ Press  button.

The telephone number last dialed will appear in the display.

- ▶ Select desired telephone number with button  or .

The letter L and the number of the memory position appears in the left-hand corner of the display. The numbers are stored in the order of the calls made.

- ▶ When you have selected a number, press  button.

The call will be made.



Accepting an incoming call

If the telephone is active in the background (reception symbol is visible in the display), the audio source is muted when an incoming call is received. A ringing tone can be heard and the caller's telephone number, or the name under which the telephone number has been saved in the telephone book, appears in the display. If the caller's number is not relayed, CALL will appear in the display.

- ▶ Press  button.

The call is accepted.

Muting a call

It is possible to mute a call; the caller is then no longer able to hear you.

- Mute on
 - ▶ Press MUT soft key.
 - ▶ MIC MUTE will appear in the display.
- Mute off
 - ▶ Press MUT soft key again.

Terminating a call

- ▶ Press  button.

The current call is terminated and the muted audio source becomes active again.

Accepting a second incoming call

If you receive another call during an already active call, you can accept the second call and switch between the two.



- Accepting a second call
 - ▶ Place new call by entering telephone number manually.



You will be notified of the second call acoustically, but you will not see this in the display.

You are connected to the second caller; the first caller is kept on hold.



Audio system

- Switching between calls
 - ▶ Press  button.
This switches between the calls.
The non-active call is kept on hold.
- Terminating a call
 - ▶ Press  button.
The current call is terminated. The connection to the caller previously kept on hold is also interrupted; however, reconnection is indicated by an acoustic signal.

Placing a second call

If you wish to place another call during an already active call, you can place the second call and switch between the callers or combine them into one call. Note that this feature is dependent on availability from your mobile phone service provider.

- Placing a second call
 - ▶ Place a new call by entering telephone number manually.
 - ▶ Press  button.
You are connected to the second caller; the first caller is kept on hold.

- Terminating a call
 - ▶ Press  button.
The current call is terminated. The connection to the caller previously kept on hold is also interrupted; however, reconnection is indicated by an acoustic signal.
- Combining two calls
 - ▶ Press  button.
The calls are combined into one call.
- Terminating a combined call
 - ▶ Press  button.
The connection to both callers is terminated.

Emergency calls “911”

The following describes how to dial a “911” emergency call using the audio system head unit when a Mercedes-Benz specified mobile phone* is inserted in the phone cradle*. Unless otherwise specified, the descriptions refer to the audio system head unit.

Consult the separate telephone operating instructions that came with your mobile phone* for information on how to place a “911” emergency call on the mobile phone*.

Warning!



The “911” emergency call system is a public service. Using it without due cause is a criminal offense.

The following conditions must be met for a “911” emergency call:

- Telephone must be switched on.
- The corresponding mobile communications network must be available.



Emergency calls may not be possible with all telephone networks or if certain network services and/or telephone functions are active. Check with your local service providers.

If you cannot make an emergency call, you will have to initiate rescue measures yourself.

GSM network phones

Placing a “911” emergency call using audio head unit with the phone locked

- ▶ Press **TEL** button to switch to telephone operation.
PIN? appears in the audio display.
- ▶ Enter 911 using the number keypad on the audio head unit.
- ▶ Press **OK** soft key or  button for dialing to begin.
DIALING appears in the audio display while the telephone establishes the connection.
- ▶ Wait until the emergency call center answers, then describe the emergency.

Audio system

Placing a “911” emergency call using audio head unit with the phone unlocked

- ▶ Press **TEL** button to switch to telephone operation.
- ▶ Enter 911 using the number keypad on the audio head unit.
- ▶ Press  button for dialing to begin.
DIALING appears in the audio display while the telephone establishes the connection.
- ▶ Wait until the emergency call center answers, then describe the emergency.



If no SIM card is in the mobile phone, NO SERVICE appears in the audio display. In that case, you only can make an emergency call on the mobile phone itself, without the use of the head unit.

TDMA/CDMA network phones

Placing a “911” emergency call using audio head unit with the phone locked

- ▶ Press **TEL** button to switch to telephone operation.
CODE? appears in the audio display.
- ▶ Enter 911 using the number keypad on the audio head unit.
- ▶ Press OK soft key or  button for dialing to begin.
DIALING appears in the audio display while the telephone establishes the connection.
- ▶ Wait until the emergency call center answers, then describe the emergency.

Placing a “911” emergency call using audio head unit with the phone unlocked

- ▶ Press **TEL** button to switch to telephone operation.
- ▶ Enter 911 using the number keypad on the audio head unit.
- ▶ Press  button for dialing to begin.
DIALING appears in the audio display while the telephone establishes the connection.
- ▶ Wait until the emergency call center answers, then describe the emergency.

▼ Power windows

Opening and closing the windows

The side windows are opened and closed electrically. The switches for all the side windows are on the driver's door. The switches for the respective windows are on the front passenger door and the rear side trim panels.

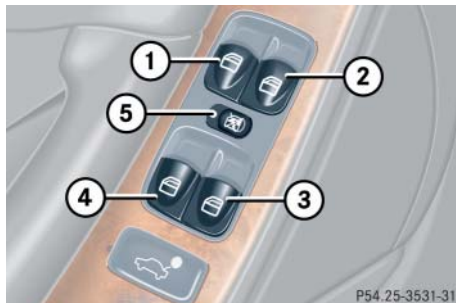

- ① Left front window
 - ② Right front window
 - ③ Right rear window
 - ④ Left rear window
 - ⑤ Rear window override switch
- (▷ page 85)

Warning!





When closing the windows, make sure there is no danger of anyone being harmed by the closing procedure.

The closing of the door windows can be immediately halted by releasing the switch or, if switch was pulled past the resistance point and released, by either pressing or pulling the respective switch.

The closing of the rear side windows can be immediately halted by releasing the switch.

The door windows are equipped with the express-close and automatic reversal function. If a door window encounters an obstruction that blocks its path in a circumstance where you pulled the switch past the resistance point and released it to close the window, the automatic reversal function will stop the window and open it slightly.

If a door window encounters an obstruction that blocks its path in a circumstance where you are closing the window by pulling and holding the switch, by pressing and holding button  on the SmartKey, by pressing and holding the lock button (vehicles with KEYLESS-GO*) on an outside door handle, by operating the soft top switch, or by pressing and holding button  or  on the climate control panel, the automatic reversal function will not operate.

When leaving the vehicle, always remove the SmartKey or SmartKey with KEYLESS-GO* from the starter switch, take it with you, and lock the vehicle. Do not leave children unattended in the vehicle, or with access to an unlocked vehicle. Unsupervised use of vehicle equipment can cause an accident and/or serious personal injury.

Power windows



You can also open or close the windows using the:

- Soft top switch (▷ page 254).
- SmartKey (summer opening/convenience feature) (▷ page 252).

Depending on current position, the windows may also open or close when:

- the air recirculation button  in the control panel of the climate control (▷ page 187) or automatic climate control (▷ page 197) is pressed and held

or

- the charcoal filter button  in the control panel of the automatic climate control (▷ page 197) is pressed and held.



Operating the rear side windows from the rear is not possible if you activate the override switch (▷ page 85).



With the SmartKey in starter switch position **0** or removed from the starter switch, the power windows can be operated:

- until you open the driver's or passenger's door.
- for at least five minutes.

- ▶ Switch on the ignition (▷ page 34).

Opening the windows

- ▶ Press switch ① to ④ to the resistance point.

The corresponding window will move downwards until you release the switch.

Closing the windows

- ▶ Pull switch ① to ④ to the resistance point.

The corresponding window will move upwards until you release the switch.

Warning!



If you pull and hold the switch up when closing the window, and upward movement of the window is blocked by some obstruction including but not limited to arms, hands, fingers, etc., the automatic reversal will not operate.

Fully opening the door windows (Express-open)

- ▶ Press switch ① or ② past the resistance point and release.

The corresponding window opens completely.

Fully closing the door windows (Express-close)

- ▶ Pull switch ① or ② past the resistance point and release.

The corresponding window closes completely.



If the upward movement of a door window is blocked during the closing procedure, the door window will stop and open slightly.

Remove the obstruction, pull the switch again past the resistance point and release.

If the door window still does not close when there is no obstruction, then pull the switch and hold it. The door window will then close without the obstruction sensor function.

Warning!



Driver's door only:

If within five seconds you again pull the switch past the resistance point and release, the automatic reversal will not function.

Stopping windows during Express-operation

- ▶ Press or pull the respective power window switch again.

Synchronizing power windows

The power windows must be resynchronized each time

- after the battery has been disconnected.
- if the power windows cannot be fully opened (Express-open) or closed (Express-close).
- ▶ Switch on the ignition (▷ page 36).
- ▶ Pull the power window switches until the side windows are closed.
- ▶ Hold the switches for approximately one second.

The power windows are synchronized.



Power windows

Summer opening feature

Warning!



Never operate the windows or soft top if there is the possibility of anyone being harmed by the opening or closing procedure.

In the event that the procedure causes potential danger, the procedure can be immediately halted by releasing the button on the SmartKey. To reverse direction of movement, press  for opening or  for closing.



If the weather is warm, you can ventilate the vehicle before driving off by simultaneously:

- opening the side windows
- opening the soft top
- turning on the seat ventilation* for the driver's seat



The seat ventilation* for the driver's seat is automatically set to the highest level if activated via summer opening feature.



- ▶ Aim transmitter eye of the SmartKey or SmartKey with KEYLESS-GO* at the driver's outside door handle. The SmartKey or SmartKey with KEYLESS-GO* must be in close proximity to the driver's outside door handle.
- ▶ Press and hold button  after unlocking the vehicle.
The windows and soft top begin to open after approximately one second.
- ▶ Release the  button to interrupt procedure.

Make sure the soft top is fully opened. If the opening procedure is finished, the multifunction display will briefly show the message **Top open**.

Convenience closing feature



Warning!



When closing the side windows and the soft top, make sure that there is no danger of anyone being harmed by the closing procedure.

The windows will not automatically re-open if blocked during convenience closing.

If potential danger exists, proceed as follows:

- Release button  to stop the closing procedure. To open, press and hold button . To continue the closing procedure after making sure that there is no danger of anyone being harmed by the closing procedure, press and hold button .

Vehicles with KEYLESS-GO*:

- Release the lock button (▷ page 60) on exterior door handle to stop the closing procedure.
- Pull on the exterior door handle and hold firmly. The side windows and the soft top will open for as long as the door handle is held but the door is not opened.

When you lock the vehicle, you can close the windows and soft top simultaneously.

- ▶ Aim transmitter eye of the SmartKey or SmartKey with KEYLESS-GO* at the driver's outside door handle (▷ page 252). The SmartKey or SmartKey with KEYLESS-GO* must be in close proximity to the driver's outside door handle.

- ▶ Press and hold button  until the windows and soft top are completely closed.

The windows and soft top begin to close after approximately one second.

- ▶ Release button  to interrupt procedure.

Make sure all side windows and the soft top are properly closed before leaving the vehicle.

Vehicles with KEYLESS-GO*:

- ▶ Press and hold the lock button on an outside door handle (▷ page 60) until the side windows are completely closed.
- ▶ Release the lock button on the outside door handle to interrupt procedure.

Power windows

Opening and closing all side windows with the soft top switch

The soft top switch is located in the center console.

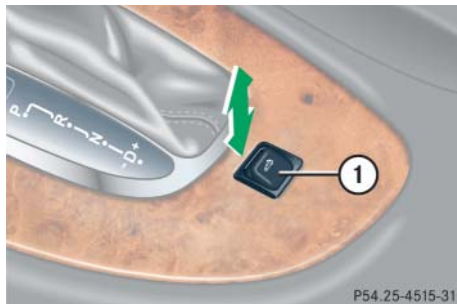

① Soft top switch

As an alternate method to using the power window switches, all side windows can be opened or closed using the soft top switch ①.

Warning!



Never operate the windows if there is the possibility of anyone being harmed by the opening or closing procedure.

In case the procedure causes potential danger, the procedure can be immediately halted by releasing the soft top switch. To open the windows again, press the soft top switch twice. Press the switch briefly the first time. Then press the switch a second time and hold it until the side windows have reached the desired position.

- ▶ Switch on the ignition.

Opening

- ▶ Press soft top switch ① twice. Press the switch briefly the first time. Then press the switch a second time and hold it until the side windows have reached the desired position.

Closing

- ▶ Pull soft top switch ① twice. Pull the switch briefly the first time. Then pull the switch a second time and hold it until the side windows have reached the desired position.

▼ Soft top

Opening and closing the soft top

For safety reasons, the soft top can only be opened and closed when the vehicle is standing still.

Warning!



Before operating the switch for the soft top, make sure no persons can be injured by the moving parts (roll bars, soft top frame, and soft top compartment cover).

Hands must never be placed near the roll bar, soft top frame, upper windshield area, shelf behind roll bar, or soft top storage compartment while the soft top is being raised or lowered. Serious personal injury may occur.

If potential danger exists, release the soft top switch. This immediately interrupts the raising or lowering procedure. You then can operate the soft top switch to raise or lower the soft top away from the danger zone.

Warning!



When leaving the vehicle, always remove the SmartKey or SmartKey with KEYLESS-GO* from the starter switch, take it with you, and lock the vehicle. Do not leave children unattended in the vehicle, or with access to an unlocked vehicle. Unsupervised use of vehicle equipment can cause an accident and/or serious personal injury.



Never sit or place heavy objects on the rear shelf. Doing so could cause damage to the soft top and the rear shelf.



When opening and closing the soft top, make sure:

- there is sufficient clearance for the soft top to move up
- the luggage cover is engaged in place (▷ page 262)
- the trunk is only loaded to the height of the luggage cover
- the luggage/cargo does not push the closed luggage cover up
- the trunk lid is closed
- nothing is placed on the soft top compartment cover
- the outside temperature is above +5°F (-15°C)

Otherwise the soft top and other parts of the vehicle could be damaged.

Soft top

Opening the soft top

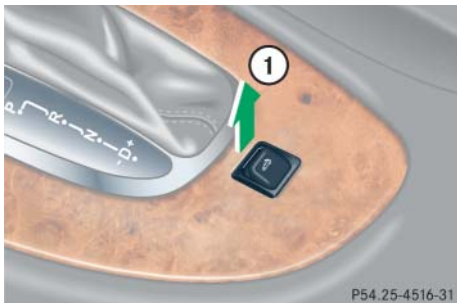

① Soft top, opening

Before pulling on the soft top switch, you must make sure:

- the parking brake is engaged (▷ page 50)
- the luggage cover is latched, see “Latch luggage cover” (▷ page 262)
- the trunk lid is closed
- the ignition is switched on (▷ page 36)



The soft top cannot be opened using the soft top switch when the roll bars have been released. The roll bars need to be lowered before the soft top can be operated again using the soft top switch. If the roll bars have released and the soft top is closed, contact an authorized Mercedes-Benz Center to have the roll bars lowered. Do not attempt to lower the roll bars manually with the soft top closed. Lowering the roll bars manually with the soft top closed may impair the function of the roll bars (▷ page 423).

If the roll bars have released and the soft top is open, you can lower the roll bars manually (▷ page 424) or contact an authorized Mercedes-Benz Center to have the roll bars lowered.

- ▶ Pull up on the soft top switch as indicated by the arrow ① until the soft top is completely lowered into its trunk storage compartment.

During the opening procedure the multifunction display shows the message *Top in operation*.

If the opening procedure is finished, the multifunction display will briefly show the message *Top open*.

If you continuously pull on the soft top switch, the windows will close.

However, the windows can also be closed/opened later on, for more information see “Opening and closing all side windows with the soft top switch” (▷ page 254), or see “Opening and closing the windows” (▷ page 249).



For safety reasons, the soft top cannot be opened while driving.

Make sure the soft top is dry before you open it. Otherwise water may enter the trunk interior.



To prevent mildew, the soft top must be dry before lowering it into the storage compartment.

Do not lower a frozen soft top until thawed and dry. Lowering a frozen soft top may result in damage not covered by the Mercedes-Benz Limited Warranty.

Warning!

Do not place anything on the soft top compartment cover.
The soft top compartment cover must never be used by any persons as a seat bench. Raising of the roll bars could result in serious personal injury.

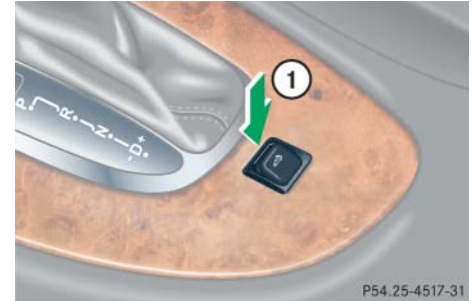
Closing the soft top

① Soft top, closing

Before pressing the soft top switch, you must make sure:

- the parking brake is engaged (▷ page 50)
- the trunk lid is closed
- the ignition is switched on (▷ page 36)

Soft top

- ▶ Press the soft top switch as indicated by the arrow  until the soft top is completely closed and locked.

During the closing procedure the multifunction display shows the message *Top in operation*.

If the soft top is closed and locked, the multifunction display will briefly show the message *Top closed*.

If you continuously press on the soft top switch the windows will close.

However, the windows can also be closed/opened later on, for more information see “Opening and closing all side windows with the soft top switch” (▷ page 254) or see “Opening and closing the windows” (▷ page 249).



For safety reasons, the soft top cannot be closed while driving.



The soft top cannot be closed using the soft top switch when the roll bars have been released. The roll bars need to be lowered before the soft top can be operated again using the soft top switch. If the roll bars have released and the soft top is open, you can lower the roll bars manually (▷ page 424) or contact an authorized Mercedes-Benz Center to have the roll bars lowered.

Warning!



To prevent possible accidents, drive the vehicle only with the soft top either completely closed and locked, or fully lowered into its storage compartment.

If the soft top does not completely open or close, a warning sounds. In the multifunction display you will see  and the message *Top being lowered* appears. After about 15 seconds the roof hydraulics lose pressure.

Properly lock the soft top (▷ page 259) before continuing to drive.

Locking the soft top after raising/lowering

Warning!



The soft top is not fully closed and locked or not fully opened if:

- the message *Top in operation* is shown in the multifunction display
- a warning sounds for 10 seconds and the message *Lock top* is shown in the multifunction display when starting to drive

To prevent possible accidents, drive the vehicle only with the soft top either completely closed and locked, or fully lowered into its storage compartment.

If the soft top is not properly locked, lock it as described below.

Unlocked status noticed when stopped

- ▶ Switch on the ignition (▷ page 36).
- ▶ To lock the soft top in its fully closed position, press soft top switch.

The message *Top closed* will be shown in the multifunction display.

or:

- ▶ To lock the soft top in its fully opened position, pull up on the soft top switch.

The message *Top open* will be shown in the multifunction display.

Unlocked status noticed while driving

Warning!



Stop the vehicle in a safe location or as soon as it is safe to do so and lock the soft top before continuing to drive. You could otherwise endanger yourself and others.

- ▶ Stop the vehicle.
- ▶ Leave the ignition switched on.
- ▶ To lock the soft top in its fully closed position, press soft top switch.

The message *Top closed* will be shown in the multifunction display.

or:

- ▶ To lock the soft top in its fully opened position, pull up on the soft top switch.

The message *Top open* will be shown in the multifunction display.

Warning!



If the soft top does not completely open or close, the roof hydraulics will lose pressure and the soft top is lowered

- after approximately seven minutes when the ignition is switched on.
- after approximately 15 seconds when the ignition is switched off.

Shortly before the soft top is lowered, a warning will sound. In the multifunction display you will see , and the message Top being lowered appears.

- Properly lock the soft top (> page 259) before continuing to drive.

Opening and closing the soft top with the SmartKey



The windows will also be opened or closed when you operate the soft top with the SmartKey.

Warning!



Before operating the soft top, make sure no persons can be injured by the moving parts (roll bar, soft top frame, and soft top compartment cover) due to negligence.

Hands must never be placed near the roll bar, soft top frame, upper windshield area, shelf behind roll bar, or soft top storage compartment while the soft top is being raised or lowered. Serious personal injury may occur.

If potential danger exists, release the respective button on the SmartKey. This immediately interrupts the raising or lowering procedure. You then can operate  to lower or  to raise the soft top away from the danger zone.



- ▶ Aim transmitter eye of the SmartKey or SmartKey with KEYLESS-GO* at the driver's outside door handle. The SmartKey or SmartKey with KEYLESS-GO* must be in close proximity to the driver's outside door handle.

Opening (Summer opening feature)

- ▶ Press and hold button  until the soft top is completely open.

The windows and soft top begin to open after approximately one second.

During the opening procedure the multifunction display shows the message `Top in operation`.

If the opening procedure is finished, the multifunction display will briefly show the message `Top open`.

- ▶ Release transmit button  to interrupt procedure.

Make sure the soft top is fully opened.

Closing (Convenience feature)

- ▶ Press and hold button  until the soft top is completely closed.

The windows and soft top begin to close after approximately one second.

During the closing procedure the multifunction display shows the message `Top in operation`.

If the soft top is closed and locked, the multifunction display will briefly show the message `Top closed`.

- ▶ Release transmit button  to interrupt procedure.

Make sure all side windows and the soft top are properly closed before leaving the vehicle.

Warning!

If the soft top does not completely open or close, a warning sounds and the soft top switch flashes. In the multifunction display you will see , and the message `Top being lowered` appears. After about 15 seconds the roof hydraulics lose pressure.

Properly lock the soft top (▷ page 259) before continuing to drive.

Soft top

Luggage cover

The luggage cover is located in the trunk.

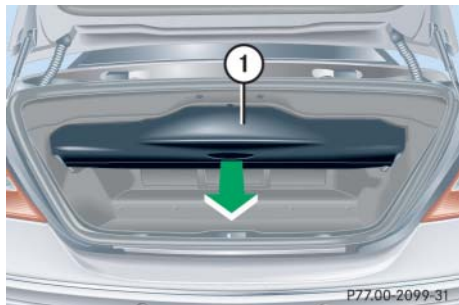

① Luggage cover

▶ Open the trunk

Latch luggage cover

▶ Pull luggage cover ① out in direction of arrow until it engages in place.

Folding back luggage cover

▶ Press luggage cover ① in direction of rear seat.



To prevent damage to the soft top or luggage/cargo when lowering the roof:

- load trunk only to the height of the luggage cover
- do not permit luggage/cargo to push up the closed luggage cover
- do not place anything on the shelf behind the roll bars
- do not place anything on the soft top compartment cover



Never place anything behind the side nets when the luggage cover has been folded back. You could forget about objects placed there, which could result in damage when operating the soft top.

Wind screen

Warning!



The wind screen can restrict the driver's vision to the rear of the vehicle. To prevent a possible accident when visibility is limited (e.g. in darkness), the upper part of the wind screen should be folded back.

The wind screen deflects drafts away from the driver and passenger when the soft top is lowered. It is stored in a separate storage bag in the trunk.

Installing

- ▶ Remove the wind screen from its storage bag.

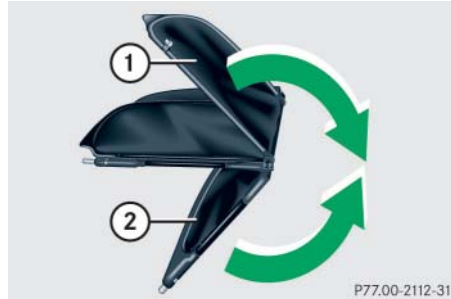

- ① Upper section
 - ② Lower section
- ▶ Fold sections ① and ② together.

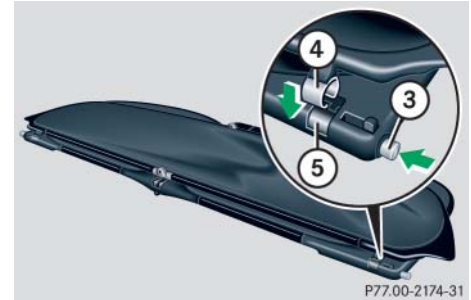

- ③ Catch
- ④ Retainer claw
- ⑤ Snap fastener

- ▶ Press retainer claw ④ on upper section into snap fastener ⑤ of lower section. ▷▷

Soft top

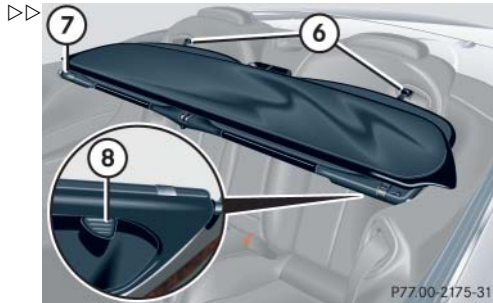

- ⑥ Retaining lugs
- ⑦ Mounting fixture on right side
- ⑧ Catch

- ▶ Fold retaining lugs ⑥ out.
- ▶ Slide pre-assembled wind screen into mounting fixture on right side ⑦ using retaining pin on right side. Simultaneously, retaining lugs ⑥ should slide into seat belt passage in rear bench seat.

- ▶ Pull catch ⑧ back and guide left retaining pin into mounting fixture on left side.
- ▶ Fold upper section of wind screen up toward head restraints until it stops.

Warning!



Check for secure locking by pulling up on the wind screen.

To prevent personal injury, remove wind screen if rear seats are to be occupied by passengers.

Removing

- ▶ Fold upper section of wind screen back down.
- ▶ Pull catch ⑧ back and pull wind screen out toward front of vehicle. Be careful not to damage interior trim with guide tabs.
- ▶ Fold retaining lugs ⑥ back.



- ⑨ Catch

- ▶ Press catch ⑨ and fold upper and lower sections back.
- ▶ Place the wind screen back into the bag.

▼ Driving systems

The driving systems of your vehicle are described on the following pages:

- Cruise control, with which the vehicle can maintain a preset speed.
- Parktronic* (Canada only), which serves as a parking assistant.

For information on the BAS, ABS, and ESP® driving systems, see “Driving safety systems” (▷ page 87).

Cruise control

Cruise control automatically maintains the speed you set for your vehicle.

Use of cruise control is recommended for driving at a constant speed for extended periods of time.

You can set or resume cruise control at any speed over 20 mph (30 km/h).

The cruise control function is operated by means of the cruise control lever.

The cruise control lever is the uppermost lever on the left-hand side of the steering column (▷ page 22).

Warning!



Cruise control is a convenience system designed to assist the driver during vehicle operation. The driver is and must remain at all times responsible for the vehicle speed and for safe brake operation.

Only use cruise control if the road, traffic and weather conditions make it advisable to travel at a steady speed.

- The use of cruise control can be dangerous on winding roads or in heavy traffic because conditions do not allow safe driving at a steady speed.
- The use of cruise control can be dangerous on slippery roads. Rapid changes in tire traction can result in wheel spin and loss of control.
- Deactivate cruise control when driving in fog.

The “Resume” function should only be operated if the driver is fully aware of the previously set speed and wishes to resume this particular preset speed.

Driving systems

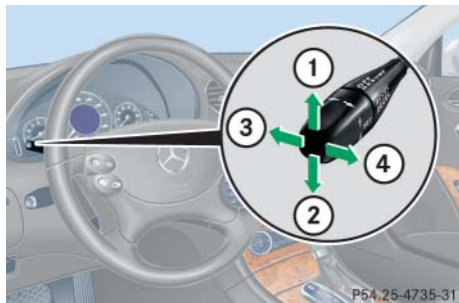

- ① Set current or higher speed
- ② Set current or lower speed
- ③ Cancel cruise control
- ④ Resume to last set speed

Warning!



Cruise control brakes automatically so that the set speed is not exceeded. The brake pedal depresses when the cruise control engages the brakes.

Keep driver's foot area clear at all times, including the area under the brake pedal. Objects stored in this area may impair pedal movement which could interfere with the braking ability of the cruise control system.

Do not place your foot under the brake pedal - your foot could become caught.

Keep in mind that cruise control is a convenience system designed to assist the driver during vehicle operation. The driver is and must always remain responsible for the vehicle's speed and for safe brake operation.

Setting current speed

- ▶ Accelerate or decelerate to the desired speed.
- ▶ Briefly lift ① or depress ② the cruise control lever (▷ page 266).
The current speed is set.
- ▶ Remove your foot from the accelerator pedal.
Cruise control is activated.

The selected speed appears in the multi-function display for approximately five seconds, and the corresponding speedometer segments from the selected speed to the vehicle maximum speed are illuminated.



On uphill or downhill grades, cruise control may not be able to maintain the set speed. Once the grade eases, the set speed will be resumed.

On downhill grades, the cruise control will hold the set speed with braking from the vehicle's brake system. In addition, on longer downhill grades the automatic transmission will automatically downshift.

Canceling cruise control

There are several ways to cancel cruise control:

- ▶ Step on the brake pedal.

Cruise control is canceled. The last speed set is stored for later use.

or

- ▶ Briefly push the cruise control lever to position ③.

Cruise control is canceled. The last speed set is stored for later use.



The last stored speed is canceled when you turn off the engine.



Cruise control automatically switched off, if

- you step on the brake pedal.
- you press the parking brake pedal.

In this case the segments in the multifunction display (▷ page 266) go out and no warning sounds.

- the vehicle speed is below 20 mph (30 km/h).
- ESP® is in operation or switched off with the ESP® switch (▷ page 90).
- you move the gear selector lever to position **N** while driving.

The segments in the multifunction display (▷ page 266) go out, and an acoustic warning sounds.



Moving gear selector lever to position **N** while driving also cancels cruise control. However, the gear selector lever should not be moved to position **N** while driving except to coast when the vehicle is in danger of skidding (e.g. on icy roads).



Depressing the accelerator pedal does not deactivate cruise control. After brief acceleration (e.g. for passing), cruise control will resume the last speed set.

Driving systems

Setting a higher speed

- ▶ Lift the cruise control lever in direction of arrow ① (▷ page 266) and hold it up until the desired speed is reached.
- ▶ Release the cruise control lever.
The new speed is set.

Setting a lower speed

- ▶ Depress the cruise control lever in direction of arrow ② (▷ page 266) and hold it down until the desired speed is reached.
- ▶ Release the cruise control lever.
The new speed is set.



When you use the cruise control lever to decelerate, the brake system will automatically brake the vehicle if the engine's braking power does not brake the vehicle sufficiently.

Fine adjustment in 1 mph (Canada: 1 km/h) increments

Faster

- ▶ Briefly tip the cruise control lever in direction of arrow ① (▷ page 266).

Slower

- ▶ Briefly tip the cruise control lever in direction of arrow ② (▷ page 266).

Setting to last stored speed ("Resume" function)

Warning!



The speed stored in memory should only be set again if prevailing road conditions permit. Possible acceleration or deceleration differences arising from returning to the pre-set speed could cause an accident and/or serious injury to you and others.

- ▶ Briefly push cruise control lever to position ④ (▷ page 266).
The cruise control resumes the last set speed.
- ▶ Remove your foot from the accelerator pedal.

The selected speed appears in the multi-function display for approximately five seconds, and the corresponding speedometer segments from the selected speed to the vehicle maximum speed are illuminated (▷ page 266).

Parktronic system (Parking assist)*, Canada only

Warning!



Parktronic is a supplemental system. It is not intended to, nor does it replace, the need for extreme care. The responsibility during parking and other critical maneuvers always rests with the driver.

Special attention must be paid to objects with smooth surfaces or low silhouettes (e.g. trailer couplings, painted posts or road curbs). Such objects may not be detected by the system and can damage the vehicle.

The operational function of the Parktronic system can be affected by dirty sensors, especially at times of snow and ice, see “Cleaning the Parktronic system* (Canada only) sensors” (▷ page 369).

Interference caused by other ultrasonic signals (e.g. working jackhammers, car wash, or the air brakes of trucks) can cause the system to send erratic indications, and should be taken into consideration.

Warning!



Make sure no persons or animals are in the area in which you are maneuvering. You could otherwise injure them.

The Parktronic system is an electronic aid designed to assist the driver during parking maneuvers. It visually and audibly indicates the relative distance between the vehicle and an obstacle.

The Parktronic system is automatically activated when you switch on the ignition (▷ page 34) and placed the gear selector lever in position **D**, **R**, or **N**.

The Parktronic system deactivates at speeds over approximately 11 mph (18 km/h). At lower speeds the Parktronic system turns on again.

The Parktronic system also deactivates when you place the gear selector lever in position **P**.

The Parktronic system monitors the surroundings of your vehicle with six sensors in the front bumper and four sensors in the rear bumper.

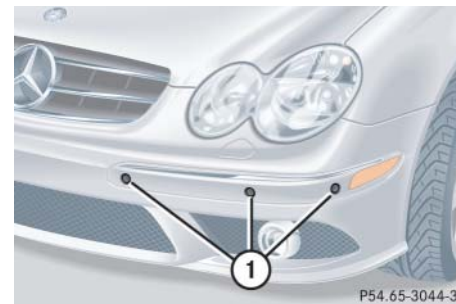

① Sensors in the front bumper

Driving systems

Range of the sensors

To function properly, the sensors must be free of dirt, ice, snow and slush. Clean the sensors regularly, being careful not to scratch or damage the sensors, see “Cleaning the Parktronic system* (Canada only) sensors” (▷ page 369).

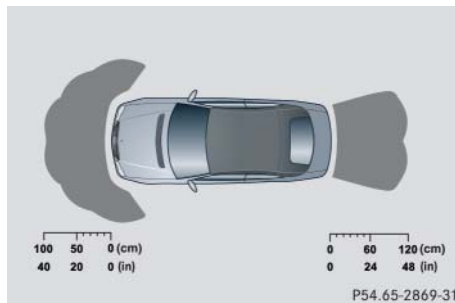
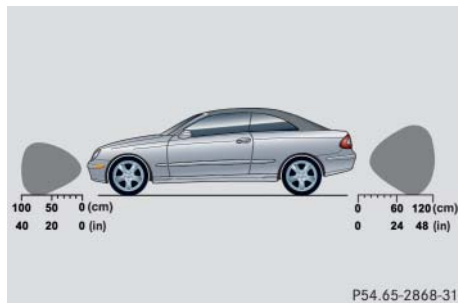

Front sensors

Center	approx. 40 in (100 cm)
Corners	approx. 24 in (60 cm)

Rear sensors

Center	approx. 48 in (120 cm)
Corners	approx. 32 in (80 cm)



During parking maneuvers, pay special attention to objects located above or below the height of the sensors (e.g. planters or trailer hitches). The Parktronic system will not detect such objects at close range and damage to your vehicle or the object may result.

Ultrasonic signals from outside sources (e.g. truck air brakes, car wash, or jackhammers) may impair the operation of the Parktronic system.

Minimum distance

Center	approx. 8 in (20 cm)
Corners	approx. 6 in (15 cm)

If the system detects an obstacle in this range, all the distance warning segments illuminate and you hear a warning signal. If the obstacle is closer than the minimum distance, the actual distance may no longer be indicated by the system.

Warning indicators

Visual signals indicate to the driver the relative distance between the sensors and an obstacle. The warning indicator for the front area is located above the center air vents in the dashboard. The warning indicator for the rear area is integrated in the rear dome lighting.

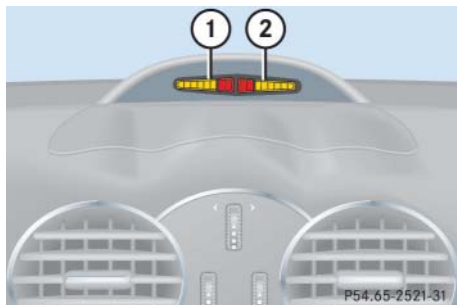

- ① Left side of the vehicle
- ② Right side of the vehicle

Each warning indicator is divided into six yellow and two red distance segments for either side of the vehicle. The Parktronic system is ready when the border around the indicator is illuminated.

The position of the gear selector lever determines which warning indicators will be activated.

Gear selector lever position	Warning indicator
D	Front area activated
R or N	Front and rear area activated
P	Neither activated

As your vehicle approaches an object, one or more distance segments will illuminate, depending on the distance. When the eighth distance segment illuminates, you have reached the minimum distance.

- **Front area:** An intermittent acoustic warning will sound as the first red distance segment illuminates and a constant acoustic warning lasting a maximum of two seconds will sound for the second red distance segment. The signal is canceled when the gear selector lever is placed in position **P**.
- **Rear area:** An intermittent acoustic warning will sound as the first red distance segment illuminates and a constant acoustic warning lasting a maximum of two seconds will sound for the second red distance segment. The signal is canceled when the gear selector lever is placed in position **D** or **P**.

Driving systems

Switching the Parktronic system on/off

The Parktronic system can be switched off manually.

The Parktronic switch is located in the upper part of the center console (▷ page 27).



- ① Parktronic switch
- ② Indicator lamp

Switching off the Parktronic system

- ▶ Press Parktronic switch ①.
- Indicator lamp ② comes on.

Switching on the Parktronic system

- ▶ Press Parktronic switch ① again.
- Indicator lamp ② goes out.



The Parktronic system is automatically switched on when the ignition is switched on (▷ page 34).

Parktronic system malfunction

If only the red distance segments illuminate and a acoustic warning sounds, there is a malfunction in the Parktronic system. The Parktronic system will automatically switch off after 20 seconds and the indicator lamp in the Parktronic switch comes on.

- ▶ Have the Parktronic system checked by an authorized Mercedes-Benz Center as soon as possible.

If only the red distance segments illuminate and no acoustic warning sounds, the Parktronic system sensors are dirty or there is an interference from other radio or ultrasonic signals. The Parktronic system will automatically switch off after 20 seconds and the indicator lamp in the Parktronic switch comes on.

- ▶ Switch off the ignition (▷ page 34).
- ▶ Clean the Parktronic system sensors (▷ page 369).

- ▶ Switch on the ignition.

or

- ▶ Check the Parktronic system operation at another location to rule out interference from outside radio or ultrasonic signals.

▼ Loading

Ski sack* (Canada only)

Unfolding and loading

- ▶ Close soft top completely (▷ page 257).
- ▶ Open the trunk.



- ▶ Fold luggage cover back in direction of the arrow.

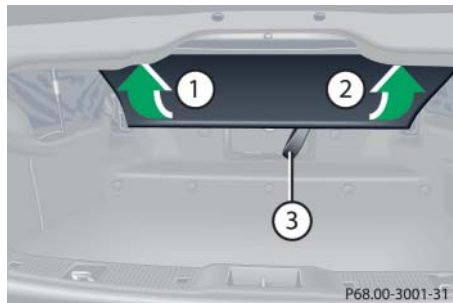

- ① Left hinge
- ② Right hinge
- ③ Pull strap

- ▶ Pull ski sack roller blind upward using pull strap ③.
- ▶ Manually fold left ① and right hinges ② of ski sack roller blind all the way up.

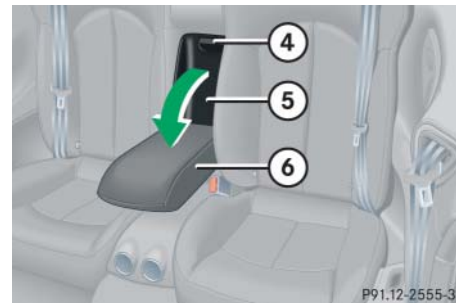

- ④ Handle
- ⑤ Cover
- ⑥ Armrest

- ▶ Fold armrest ⑥ down (arrow).
- ▶ Pull handle ④ and swing cover ⑤ down.



Loading



- ⑦ Hook and loop fastener
- ▶ Unfasten hook and loop fastener ⑦.
- ▶ Pull ski sack into passenger compartment and unfold.

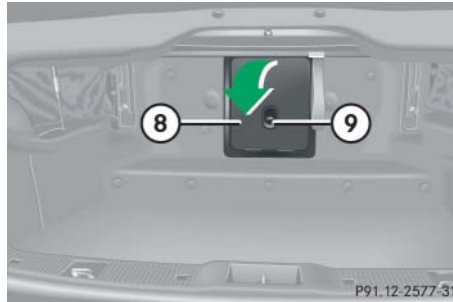

- ⑧ Flap
- ⑨ Catch
- ▶ Pull down catch ⑨.
- ▶ Open the flap ⑧ downwards in the direction of the arrow.



- ▶ From trunk, slide skis into ski sack.

Warning!



The ski sack is designed for up to two pairs of skis. Do not load the ski sack with other objects.

Always fasten the ski sack securely. In an accident, an unfastened ski sack can cause injury to vehicle occupants.

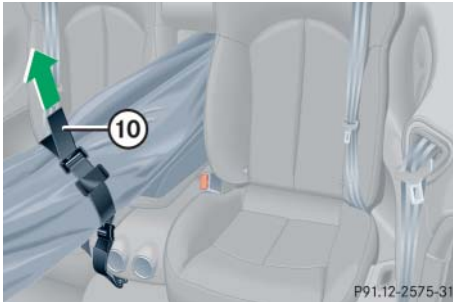

⑩ Strap

- ▶ Tighten strap ⑩ by pulling at the loose end (arrow) until the skis in the ski sack are tightly secured.

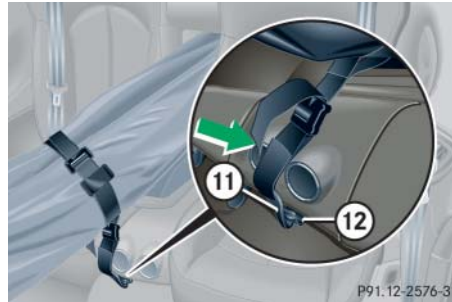

⑪ Hook

⑫ Eye

- ▶ Connect hook ⑪ to eye ⑫ located on center tunnel in front of rear seat bench.
- ▶ Tighten strap by pulling at the loose end (arrow).

Unloading and folding

- ▶ Loosen both straps.
- ▶ Disconnect hook ⑪ from eye ⑫.
- ▶ Unload skis.
- ▶ Close flap ⑧ in trunk.
- ▶ Fold and flatten ski sack lengthwise.
- ▶ Place folded ski sack inside recess of backrest.
- ▶ Fasten hook and loop fastener.



- ▶ Close ski sack compartment cover.

Loading

Closing ski sack roller blind

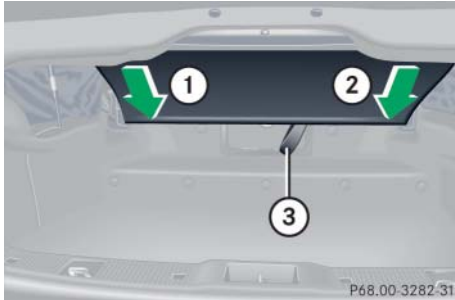

- ① Left hinge
- ② Right hinge
- ③ Pull strap

- ▶ Pull ski sack roller blind downward using pull strap ③.
- ▶ Manually fold left ① and right hinges ② of ski sack roller blind all the way down.

- ▶ To snap ski sack roller blind into place, press left and right hinges where the word PRESS can be seen.
- ▶ Fold luggage cover back and close it securely (▷ page 262).

Removing the ski sack

For ski sack removal, we recommend that you contact an authorized Mercedes-Benz Center.

Warning!



Never drive vehicle with trunk open while the ski sack is removed. Deadly carbon monoxide (CO) gases may enter vehicle interior, resulting in unconsciousness and death.



To prevent unauthorized persons from access to the trunk, always close the flap.

Loading instructions

The total load weight including vehicle occupants and luggage/cargo should not exceed the load limit or vehicle capacity weight indicated on the corresponding placard located on the driver's door B-pillar (▷ page 333).

The handling characteristics of a fully loaded vehicle depend greatly on the load distribution. It is therefore recommended to load the heaviest items being placed towards the front of the vehicle.

Always place items being carried against rear seat backrests, and fasten them as securely as possible.

The heaviest portion of the cargo should always be kept as low as possible since it influences the handling characteristics of the vehicle.



To prevent damage to the soft top or luggage/cargo when lowering the roof:

- load trunk only to the height of the luggage cover
- do not permit luggage/cargo to push up the closed luggage cover
- do not place anything on the shelf behind the roll bar
- do not place anything on the soft top compartment cover

Warning!



Always fasten items being carried as securely as possible.

In an accident, during hard braking or sudden maneuvers, loose items will be thrown around inside the vehicle and can cause injury to vehicle occupants unless the items are securely fastened in the vehicle.

To help avoid personal injury during a collision or sudden maneuver, exercise care when transporting cargo. Put luggage or cargo in the trunk if possible.

Never drive vehicle with trunk open. Deadly carbon monoxide (CO) gases may enter vehicle interior resulting in unconsciousness and death.

Useful features

Storage compartments

Warning!



To help avoid personal injury during a collision or sudden maneuver, exercise care when storing objects in the vehicle. Put luggage or cargo in the trunk if possible. Do not pile luggage or cargo higher than the seat backs.

Parcel nets cannot secure hard or heavy objects.

Keep compartment lids closed. This will help to prevent stored objects from being thrown about and injuring vehicle occupants during an accident.



Make sure no objects fall into the openings of the subwoofer between the rear seats.

If necessary, contact an authorized Mercedes-Benz Center to remove any objects which may have fallen into the openings.

Glove box

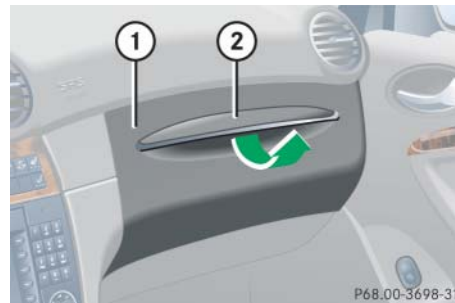

- ① Glove box lid
- ② Glove box lid release

Opening the glove box

- ▶ Pull glove box lid release ②.

The glove box lid ① opens downward.

Closing the glove box

- ▶ Push glove box lid ① up to close.



Audio system/COMAND* with CD changer*: The CD changer* is located in the glove box.

Storage box (Center armrest design A)

The storage box is in front of the armrest storage compartment.

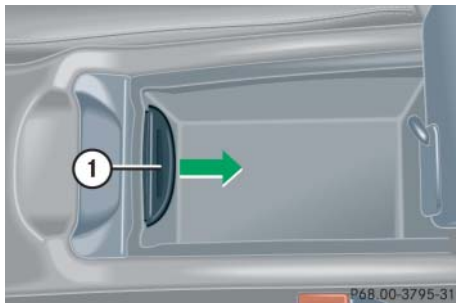

① Storage box

Warning!

Do not use this storage compartment as an ashtray and/or place hot cigarettes or other hot smoking materials in the storage box. Placing such materials in the storage box may cause vehicle damage and/or potentially cause a vehicle fire.

Opening storage box

- ▶ Pull storage box ① in the direction of arrow.

Closing storage box

- ▶ Press storage box ① back until it engages into place.

Useful features

Ruffled storage bags



① Ruffled storage bags

Storage bags are located on the rear side of the front seats.

Warning!



The ruffled storage bag is intended for storing light-weight items only.

Heavy objects, objects with sharp edges or fragile objects may not be transported in the ruffled storage bag. In an accident, during hard braking, or sudden maneuvers, they could be thrown around inside the vehicle and cause injury to vehicle occupants.

The ruffled storage bag cannot protect transported goods in the event of an accident.

Parcel net in front passenger footwell

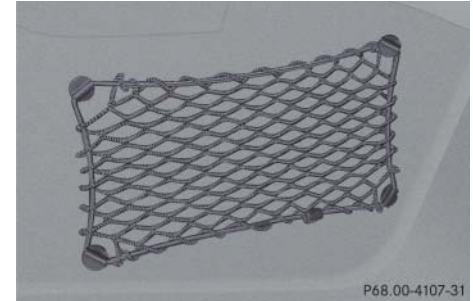

① Parcel net

A small convenience parcel net is located in the front passenger footwell. It is for small and light items, such as road maps, mail, etc.

Warning!

The parcel net is intended for storing light-weight items only.

Heavy objects, objects with sharp edges or fragile objects may not be transported in the parcel net. In an accident, during hard braking, or sudden maneuvers, they could be thrown around inside the vehicle and cause injury to vehicle occupants.

The parcel net cannot protect transported goods in the event of an accident.

Center armrest

Depending on vehicle production date, your vehicle is equipped with either armrest design A or B

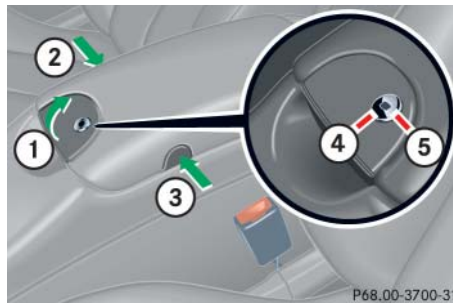
Armrest design A

- ① Handle
- ② Button (passenger side)
- ③ Button (driver side)
- ④ Compartment lock (lock position)
- ⑤ Compartment lock (unlock position)

Opening storage compartment

- ▶ Pull handle ① and lift armrest.

Closing storage compartment

- ▶ Press armrest down until it engages into place.

Opening telephone compartment

- ▶ Press button ③ on driver's side or button ② on passenger side and lift armrest.

Closing telephone compartment

- ▶ Press armrest down until it engages into place.

Useful features

Locking compartment

- ▶ Remove the mechanical key from the SmartKey (▷ page 419).
- ▶ Turn the compartment lock to position ⑤.

Unlocking compartment

- ▶ Turn the compartment lock to position ④.
- ▶ Insert the mechanical key in the SmartKey.

Armrest design B

The compartment in the center armrest contains a cup holder and the telephone* compartment.

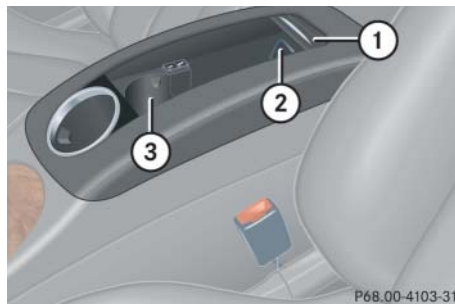

- ① Cover
- ② Telephone* compartment
- ③ Cup holder

Opening compartment

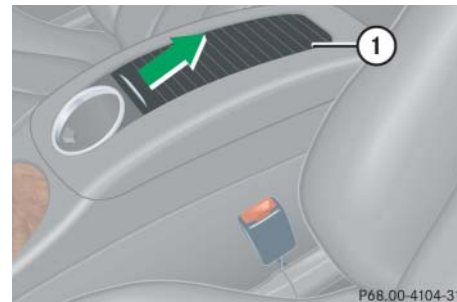

- ① Cover
- ▶ Slide cover ① in direction of arrow.

Closing compartment

- ▶ Slide cover ① back.

Opening telephone compartment

- ▶ Slide cover ① in direction of arrow and open it fully.

Closing telephone compartment

- ▶ Slide cover ① back.

Armrest in the rear passenger compartment



- ▶ Pull the top of the armrest out and fold it down.

Cup holders

Warning!



In order to help prevent spilling liquids on vehicle occupants and/or vehicle equipment, only use containers that fit into the cup holder. Use lids on open containers and do not fill containers to a height where the contents, especially hot liquids, could spill during braking, vehicle maneuvers, or in an accident. Liquids spilled on vehicle occupants may cause serious personal injury. Liquids spilled on vehicle equipment may cause damage not covered by the Mercedes-Benz Limited Warranty

When not in use, keep the cup holder closed. An open cup holder may cause injury to you and others when contacted during braking, vehicle maneuvers, or in an accident.



Useful features

- ▷▷ Keep in mind that objects placed in cup holder may come loose during braking, vehicle maneuvers, or in an accident and be thrown around in the vehicle interior. Objects thrown around in the vehicle interior may cause an accident and/or serious personal injury.

Cup holder in the center armrest

Only vehicles with center armrest design B (▷ page 282).

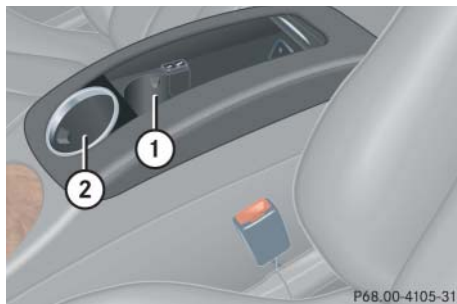

- ① Cup holder in compartment (▷ page 282)
- ② Cup holder

Cup holder in the dashboard

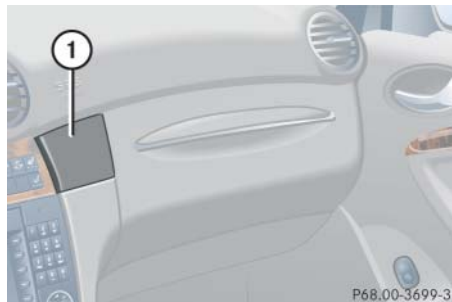

- ① Cover

Opening cup holder

- ▶ Push cover ①.
The cup holder opens automatically.

Closing cup holder

- ▶ Push the cup holder back until it engages.

Ashtrays

Center console ashtray



- ① Cover plate
- ② Sliding button
- ③ Ashtray insert

Opening ashtray

- ▶ Briefly press the bottom of cover plate ①.
The cover plate opens automatically.

Removing ashtray insert

Warning!



Remove front ashtray only with vehicle standing still. Set the parking brake to secure vehicle from movement. Move gear selector lever to position **N**. With gear selector lever in position **N**, turn off the engine.

- ▶ Secure vehicle from movement by setting the parking brake.
- ▶ Move the gear selector lever to position **N**.

Now you have more room to take out the insert.

- ▶ Push sliding button ② to the right.
The ashtray is disengaged and slides a short way in direction of arrow ③.
- ▶ Remove the ashtray insert.

Reinstalling the ashtray insert

- ▶ Push the ashtray insert ③ down into the retainer until it engages.
- ▶ Push down cover plate ① to close ashtray.

The cover plate engages.

Rear seat ashtray

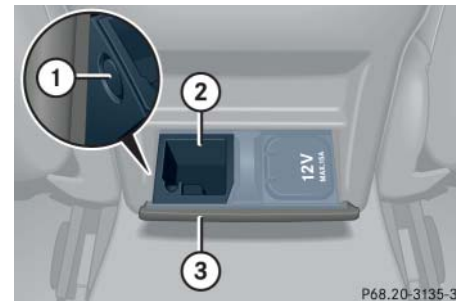

P68.20-3135-31

- ① Button
- ② Ashtray insert
- ③ Cover

Useful features

Opening ashtray

- ▶ Pull at top of cover ③.

Removing ashtray insert

- ▶ Push button ① to disengage ashtray insert ② and remove it.

Reinstalling ashtray insert

- ▶ Push the ashtray insert ② down into the retainer until it engages.
- ▶ Push at top of cover ③ to close ashtray.

Cigarette lighter

Warning!



Never touch the heating element or sides of the cigarette lighter; they are extremely hot. Hold the knob only.

When leaving the vehicle, always remove the SmartKey or SmartKey with KEYLESS-GO* from the starter switch, take it with you, and lock the vehicle. Do not leave children unattended in the vehicle, or with access to an unlocked vehicle. Unsupervised use of vehicle equipment may cause an accident and/or serious personal injury.

- ▶ Switch on the ignition (▷ page 36).



① Cover

② Cigarette lighter

- ▶ Briefly press the bottom of cover plate ①.

The cover plate opens automatically.

- ▶ Push in cigarette lighter ②.

The cigarette lighter will pop out automatically when hot.

- ▶ Push down cover plate ① to close ashtray.

The cover plate engages.



The lighter socket can accommodate 12V DC electrical accessories (up to a maximum of 85 W) designed for use with the standard “cigarette lighter” plug type. Keep in mind, however, that connecting accessories to the lighter socket (for example extensive connecting and disconnecting, or using plugs that do not fit properly) can damage the lighter socket. With the socket damaged, the lighter may no longer be able to be placed in the heating (pushed-in) position, or the lighter may pop out too early with the lighter not hot enough.

To help avoid damaging the cigarette lighter socket, we recommend connecting 12V DC electrical accessories designed for use with the standard “cigarette lighter” plug type to the 12V power outlet (▷ page 287) in your vehicle whenever possible.

Power outlet in the rear passenger compartment

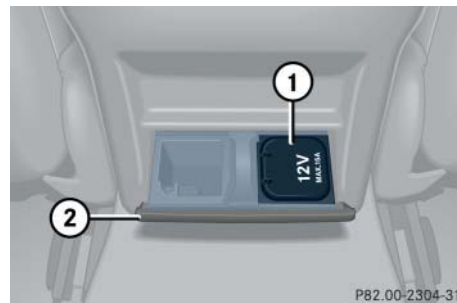

- ① Power outlet
- ② Cover
- ▶ Switch on the ignition (▷ page 36).
- ▶ Pull at top of cover ②.
- ▶ Flip cover ① to the left and insert electrical plug (cigarette lighter type).



The power outlet can be used to accommodate electrical consumers (e.g. air pump, auxiliary lamps) up to a maximum of 180 W.

Floormats*

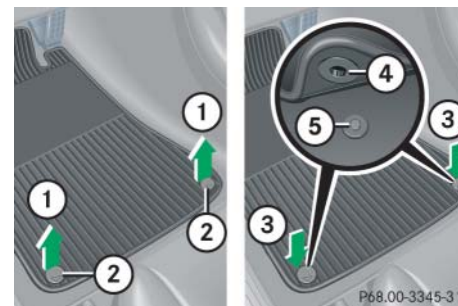

Removing

- ▶ Pull floormats off of retainer pins ② in direction of arrow ①.
- ▶ Remove the floormats.

Installing

- ▶ Lay down the floormat.
- ▶ Press the floormat eyelets ④ onto retainer pins ⑤ in direction of arrow ③.

Warning!



Whenever you are using floormats, make sure there is enough clearance and that the floormats are securely fastened.

Floormats should always be securely fastened using eyelets ④ and retainer pins ⑤.

Before driving off, check that the floormats are securely in place and adjust them if necessary. A loose floormat could slip and hinder proper functioning of the pedals.

Telephone*

Warning!



Never operate radio transmitters equipped with a built-in or attached antenna (i.e. without being connected to an external antenna) from inside the vehicle while the engine is running. Doing so could lead to a malfunction of the vehicle's electronic system, possibly resulting in an accident and/or serious personal injury.

Radio transmitters, such as a portable telephone or a citizens band unit, should only be used inside the vehicle if they are connected to an antenna that is installed on the outside of the vehicle.

The external antenna must be approved by Mercedes-Benz. Please contact an authorized Mercedes-Benz Center for information on the installation of an approved external antenna. Refer to the radio transmitter operation instructions regarding use of an external antenna.

Warning!





Please do not forget that your primary responsibility is to drive the vehicle. A driver's attention to the road must always be his/her primary focus when driving. For your safety and the safety of others, we recommend that you pull over to a safe location and stop before placing or taking a telephone call.

If you choose to use the telephone¹ while driving, please use the hands-free device and only use the telephone when road, weather and traffic conditions permit. Some jurisdictions prohibit the driver from using a cellular telephone while driving a vehicle.

Only operate the audio system or CO-MAND* (Cockpit Management and Data System)¹ if road, weather and traffic conditions permit.

¹ Observe all legal requirements.

Bear in mind that at a speed of just 30 mph (approximately 50 km/h), your vehicle is covering a distance of 44 feet (approximately 14 m) every second.

You can take and place telephone calls using the  and  buttons on the steering wheel. To carry out other telephone functions, use the control system (▷ page 163).

See separate operating manual for instructions on how to use the telephone.

Tele Aid



The initial activation of the Tele Aid system may only be performed by completing the subscriber agreement and placing an acquaintance call using the  button. Failure to complete either of these steps will result in a system that is not activated.

If you have any questions regarding activation, please call the Response Center at 1-800-756-9018 (in the USA) or 1-888-923-8367 (in Canada).



The Tele Aid system



(Telematic Alarm Identification on Demand)

The Tele Aid system consists of three types of response:

- automatic and manual emergency
- roadside assistance and
- information



The Tele Aid system is operational providing that the vehicle's battery is charged, properly connected, not damaged and cellular and GPS coverage is available.

The speaker volume of a Tele Aid call can be adjusted when using the volume control on the multifunction steering wheel. To raise, press button  and to lower, press button . The volume can also be adjusted using the volume knob on your audio system or COMAND* head unit.

- ▶ To activate, press the SOS button, the Roadside Assistance button  or the Information button , depending on the type of response required.



The SOS button is located above the interior rear view mirror.

The Roadside Assistance button  and the Information button  are located below the center armrest cover.



Useful features

Shortly after the completion of your Tele Aid acquaintance call, you will receive a user ID and password. By visiting www.mbusa.com and selecting “Tele Aid” (USA only), you will have access to account information, remote door unlock and more.



The Tele Aid system utilizes the cellular network for communication and the GPS (Global Positioning System) satellites for vehicle location. If either of these signals is unavailable, the Tele Aid system may not function and if this occurs, assistance must be summoned by other means.

System self-check

Initially, after switching on the ignition, malfunctions are detected and indicated (the indicator lamps in the SOS button, the Roadside Assistance button  and the Information button  stay on longer than ten seconds or do not come on). The

message Tele Aid malfunction Drive to workshop appears in the multifunction display.

Warning!



If the indicator lamps in the SOS button, in the Roadside Assistance button and/or in the Information button remain illuminated constantly in red and/or message Tele Aid malfunction Drive to workshop is displayed in the multifunction display after the system self-check, a malfunction in the system has been detected.

If a malfunction is indicated as outlined above, the system may not operate as expected. Have the system checked at the nearest Mercedes-Benz Center as soon as possible.

Emergency calls

An emergency call is initiated automatically following an accident in which the emergency tensioning devices (ETDs) or air bags deploy.

An emergency call can also be initiated manually by opening the cover next to the interior rear view mirror labeled SOS, then briefly pressing the button located under the cover. See (> page 291) for instructions on initiating an emergency call manually.

Once the emergency call is in progress, the indicator lamp in the SOS button will begin to flash. The message Connecting call appears in the multifunction display and the audio system is muted. When the connection is established, the message Call connected appears in the multifunction display. All information relevant to the emergency, such as the location of the vehicle (determined by the GPS satellite location system), vehicle model, identification number and color are generated.

A voice connection between the Response Center and the occupants of the vehicle will be established automatically soon after the emergency call has been initiated. The Response Center will attempt to determine more precisely the nature of the emergency provided they can speak to an occupant of the vehicle.

The Tele Aid system is available if:

- it has been activated and is operational. Activation requires a subscription for monitoring services, connection and cellular air time
- the relevant cellular phone network and GPS signals are available and pass the information on to the Response Center



Location of the vehicle on a map is only possible if the vehicle is able to receive signals from the GPS satellite network and pass the information on to the Response Center.

Warning!



If the indicator lamp in the SOS button is flashing continuously and there was no voice connection to the Response Center established, then the Tele Aid system could not initiate an emergency call (e.g. the relevant cellular phone network is not available). The message `Call failed` appears in the multifunction display for approximately ten seconds.

Should this occur, assistance must be summoned by other means.

Initiating an emergency call manually



- ① Cover
- ② SOS button

- ▶ Briefly press on cover ①.

The cover will open.

- ▶ Press SOS button ② briefly.

The indicator lamp in SOS button ② will flash until the emergency call is concluded.



Useful features

- ▷▷ Wait for a voice connection to the Response Center.
- ▶ Close cover  after the emergency call is concluded.

Warning!



If you feel at any way in jeopardy when in the vehicle (e.g. smoke or fire in the vehicle, vehicle in a dangerous road location), please do not wait for voice contact after you have pressed the emergency button. Carefully leave the vehicle and move to a safe location. The Response Center will automatically contact local emergency officials with the vehicle's approximate location if they receive an automatic SOS signal and cannot make voice contact with the vehicle occupants.

Roadside Assistance button

The Roadside Assistance button  is located below the center armrest cover.

- ▶ Press and hold the  button (for longer than two seconds).

A call to a Mercedes-Benz Roadside Assistance dispatcher will be initiated. The  button will flash while the call is in progress. The message *Connecting call* will appear in the multifunction display and the audio system is muted.

When the connection is established, the message *Call connected* appears in the multifunction display. The Tele Aid system will transmit data generating the vehicle identification number, model, color and location (subject to availability of cellular and GPS signals).

A voice connection between the Roadside Assistance dispatcher and the occupants of the vehicle will be established.



- ▶ Describe the nature of the need for assistance.

The Mercedes-Benz Roadside Assistance dispatcher will either dispatch a qualified Mercedes-Benz technician or arrange to tow your vehicle to the nearest authorized Mercedes-Benz Center. For services such as labor and/or towing, charges may apply. Refer to the Roadside Assistance manual for more information.

The following is only available in the USA:

- Sign and Drive services: Services such as jump start, a few gallons of fuel or the replacement of a flat tire with the vehicle spare tire are obtainable.



The indicator lamp on the Roadside Assistance button  remains illuminated in red for approximately ten seconds during the system self-check after switching on the ignition (together with the SOS button and the Information button .

See system self-check (▷ page 290) when the indicator lamp does not come on in red or stays on longer than approximately ten seconds.

If the indicator lamp on the Roadside Assistance button  is flashing continuously and there was no voice connection to the Response Center established, then the Tele Aid system could not initiate a Roadside Assistance call (e.g. the relevant cellular phone network is not available). The message `Call failed` appears in the multifunction display.

Roadside Assistance calls can be terminated using the  button on the multifunction steering wheel or the respective button for ending a telephone call on the audio system or the COMAND* headunit.

Information button

The Information button  is located below the center armrest cover.

- ▶ Press and hold the  button (for longer than two seconds).

A call to the Customer Assistance Center will be initiated. The button will flash while the call is in progress. The message `Connecting call` will appear in the multifunction display and the audio system is muted.



When the connection is established, the message `Call connected` appears in the multifunction display. The Tele Aid system will transmit data generating the vehicle identification number, model, color and location (subject to availability of cellular and GPS signals).

A voice connection between the Customer Assistance Center representative and the occupants of the vehicle will be established. Information regarding the operation of your vehicle, the nearest

Mercedes-Benz Center or Mercedes-Benz USA products and services is available to you.

For more details concerning the Tele Aid system, please visit www.mbusa.com and use your ID and password (sent to you separately) to learn more (USA only).



The indicator lamp on the Information button  remains illuminated in red for approximately ten seconds during the system self-check after switching on ignition (together with the SOS button and the Roadside Assistance button ).

See System self-check (▷ page 290) when the indicator lamp does not come on in red or stays on longer than approximately ten seconds.

Useful features

If the indicator lamp on the Information button  is flashing continuously and there was no voice connection to the Response Center established, then the Tele Aid system could not initiate an Information call (e.g. the relevant cellular phone network is not available). The message `Call failed` appears in the multifunction display.

Information calls can be terminated using the  button on the multifunction steering wheel or the respective button for ending a telephone call on the audio system or the COMAND* headunit.



If the indicator lamps do not start flashing after pressing one of the buttons or remain illuminated (in red) at any time, the Tele Aid system has detected a malfunction or the service is not currently active, and may not initiate a call. Visit an Mercedes-Benz Center and have the system checked or contact the Response Center at 1-800-756-9018 (in the USA) or 1-888-923-8367 (in Canada) as soon as possible.

Call priority

If other service calls such as a Roadside Assistance call or Information call are active, an Emergency call is still possible. In this case, the Emergency call will take priority and override all other active calls.



The indicator lamp in the respective button flashes until the call is concluded. Calls can only be terminated by a Response Center or Customer Assistance Center representative except Roadside Assistance and Information calls, which can also be terminated by pressing button  on the multifunction steering wheel or the respective button for ending a telephone call on the audio system or the COMAND* head unit.



If the indicator lamp continues to flash or the system does not reset, contact the Response Center at 1-800-756-9018 (in the USA), or 1-888-923-8367 (in Canada), or Mercedes-Benz Customer Assistance at 1-800-FOR-MERCEdes (1-800-367-6372) in the USA, or Customer Service at 1-800-387-0100 in Canada.



When a Tele Aid call has been initiated, the audio system or the COMAND* system audio is muted and the selected mode (radio or CD) pauses. The optional cellular phone (if installed) switches off. If you must use this phone, the vehicle must be parked. Disconnect the coiled cord and place the call. The COMAND* navigation system (if engaged) will continue to run. The display in the instrument cluster is available for use, and spoken commands are only available by pressing the RPT button on the COMAND* headunit. A pop-up window will appear in the COMAND* display to indicate that a Tele Aid call is in progress.

Remote door unlock

In case you have locked your vehicle unintentionally (e.g. SmartKey inside vehicle), and the reserve SmartKey is not handy:

- ▶ Contact the Mercedes-Benz Response Center at 1-800-756-9018 (in the USA) or 1-888-923-8367 (in Canada).

You will be asked to provide your password which you provided when you completed the subscriber agreement.

- ▶ Then return to your vehicle and pull the trunk recessed handle for a minimum of 20 seconds until the SOS button is flashing.

The message *Connecting call* appears in the multifunction display.

As an alternative, you may unlock the vehicle via Internet using the ID and password sent to you shortly after the completion of your acquaintance call.

The Response Center will then unlock your vehicle with the remote door unlocking feature.



The remote door unlock feature is available if the relevant cellular phone network is available.

The SOS button will flash and the message *Connecting call* will appear in the multifunction display to indicate receipt of the door unlock command.

Once the vehicle is unlocked, a Response Center specialist will attempt to establish voice contact with the vehicle occupants.

If the trunk recessed handle was pulled for more than 20 seconds before door unlock authorization was received by the Response Center, you must wait 15 minutes before pulling the trunk recessed handle again.

Useful features

Stolen Vehicle Recovery services

In the event your vehicle was stolen:

- ▶ Report the incident to the police.
The police will issue a numbered incident report.
- ▶ Pass this number on to the Mercedes-Benz Response Center along with your password issued to you when you subscribed to the service.

The Response Center will then attempt to covertly contact the vehicle's Tele Aid system. Once the vehicle is located, the Response Center will contact the local law enforcement and you. The vehicle's location will only be provided to law enforcement.



When the anti-theft alarm or the tow-away alarm stays on for more than 30 seconds, a call is initiated automatically to the Response Center, see "Anti-theft alarm system" (▷ page 92) and tow-away alarm (▷ page 94).

Garage door opener*

The integrated remote control is capable of operating up to three separately controlled devices. It provides a convenient way to replace up to three hand-held remote controls used to operate devices such as garage door openers, gate openers, or other devices compatible with HomeLink® or some other systems.

Before the integrated remote control can be used, it must be programmed to the garage door opener, gate operator or other device you wish to operate. See the following instructions for programming information.

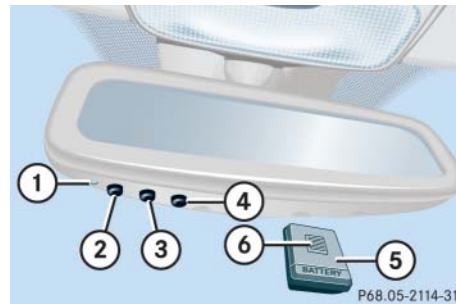

Interior rear view mirror with integrated remote control

- ① Indicator lamp
- ② ③ ④ Signal transmitter button

Needed for programming (not part of vehicle equipment):

- ⑤ Hand-held remote control of garage door opener, gate operator or other device
- ⑥ Hand-held remote control button

Warning!

Before programming the integrated remote control to a garage door opener or gate operator, make sure people and objects are out of the way of the device to prevent potential harm or damage. When programming a garage door opener, the door moves up or down. When programming a gate operator, the gate opens or closes.

Do not use the integrated remote control with any garage door opener that lacks safety stop and reverse features as required by U.S. federal safety standards (this includes any garage door opener model manufactured before April 1, 1982).

A garage door that cannot detect an object - signaling the door to stop and reverse - does not meet current U.S. federal safety standards.

When programming a garage door opener, park the vehicle outside the garage.

Do not run the engine while programming the integrated remote control. Inhalation of exhaust gas is hazardous to your health. All exhaust gas contains carbon monoxide, and inhaling it can cause unconsciousness and possible death.

Programming the integrated remote control

Step 1:

- ▶ Switch on the ignition (▷ page 36).

Step 2:

- ▶ If you have previously programmed an signal transmitter button and wish to retain its programming, proceed to step 3.

If you are programming the integrated remote control for the first time, press and hold the two outer signal transmitter buttons ② and ④ and release them only when the indicator lamp ① begins to flash after approximately 20 seconds (do not hold the button for longer than 30 seconds). This procedure erases any previous settings for all three channels and initializes the memory.



Useful features

- ▷▷ If you later wish to program a second and/or third hand-held transmitter to the remaining two signal transmitter buttons, do not repeat this step and begin directly with step 3.

Step 3:

- ▶ Hold the end of the hand-held remote control ⑤ of the device you wish to train approximately 2 to 5 in (5 to 12 cm) away from the signal transmitter button (②, ③ or ④) to be programmed, while keeping the indicator lamp ① in view.

Step 4:

- ▶ Using both hands, simultaneously press the hand-held remote control button ⑥ and the desired signal transmitter button (②, ③ or ④). Do not release the buttons until step 5 is completed.

The indicator lamp ① will flash, first slowly and then rapidly.



The indicator lamp ① flashes immediately the first time the signal transmitter button is programmed. If this button has already been programmed, the indicator lamp will only start flashing after 20 seconds.

Step 5:

- ▶ After the indicator lamp ① changes from a slow to a rapidly flashing light, release the hand-held remote control button and the signal transmitter button.

Step 6:

- ▶ Press and hold the just-trained signal transmitter button (②, ③ or ④) and observe the indicator lamp ①.

If the indicator lamp ① stays on constantly, programming is complete and your device should activate when the respective signal transmitter button (②, ③ or ④) is pressed and released.



If the indicator lamp ① flashes rapidly for about 2 seconds and then turns to a constant light, continue with programming steps 8 through 12 as your garage door opener may be equipped with the “rolling code” feature.

Step 7:

- ▶ To program the remaining two signal transmitter buttons, repeat the steps above starting with step 3.

Rolling code programming

To train a garage door opener (or other rolling code devices) with the rolling code feature, follow these instructions after completing the “Programming” portion (steps 1 through 6) of this text. (A second person may make the following training procedures quicker and easier.)

Step 8:

- ▶ Locate “training” button on the garage door opener motor head unit.

Exact location and color of the button may vary by garage door opener brand. Depending on manufacturer, the “training” button may also be referred to as “learn” or “smart” button. If there is difficulty locating the transmitting button, refer to the garage door opener operator’s manual.

Step 9:

- ▶ Press the “training” button on the garage door opener motor head unit.

The “training light” is activated.

You have 30 seconds to initiate the following two steps.

Step 10:

- ▶ Return to the vehicle and firmly press, hold for 2 seconds and release the programmed signal transmitter button (②, ③ or ④).

Step 11:

- ▶ Press, hold for 2 seconds and release same signal transmitter button a second time to complete the training process.



Useful features



Some garage door openers (or other rolling code equipped devices) may require you to press, hold for 2 seconds and release the same signal transmitter button a third time to complete the training process.

Step 12:

- ▶ Confirm the garage door operation by pressing the programmed signal transmitter button (②, ③ or ④).

Step 13:

- ▶ To program the remaining two signal transmitter buttons, repeat the steps above starting with step 3.

Gate operator/Canadian programming

Canadian radio-frequency laws require transmitter signals to “time-out” (or quit) after several seconds of transmission which may not be long enough for the integrated signal transmitter to pick up the signal during programming. Similar to this Canadian law, some U.S. gate operators are designed to “time-out” in the same manner.

If you live in Canada or if you are having difficulties programming a gate operator (regardless of where you live) by using the programming procedures, replace step 4 with the following:

Step 4:

- ▶ Press and hold the signal transmitter button (②, ③ or ④). Do not release this button until it has been successfully trained.

- ▶ While still holding down the signal transmitter button (②, ③ or ④), “cycle” your hand-held remote control button (⑥) as follows: Press and hold button (⑥) for 2 seconds, then release it for 2 seconds, and again press and hold it for 2 seconds. Repeat this sequence on the hand-held remote control until the frequency signal has been learned. Upon successful training, the indicator lamp (①) will flash slowly and then rapidly after several seconds.
- ▶ Proceed with programming step 5 and step 6 to complete.



Upon completion of programming the integrated remote control, make sure you retain the hand-held remote control that came with the garage door opener, gate operator or other device. You may need it for use in other vehicles, for future programming of an integrated remote control, or simply for continued use as a hand-held remote control to operate the respective device in other situations.

Reprogramming a single signal transmitter button

To program a device using a signal transmitter button previously trained, follow these steps:

- ▶ Switch on the ignition (▷ page 36).
- ▶ Press and hold the desired signal transmitter button (②, ③ or ④). Do not release the button.
- ▶ The indicator lamp ① will begin to flash after 20 seconds. Without releasing the signal transmitter button, proceed with programming starting with step 3.

Operation of integrated remote control

- ▶ Switch on the ignition (▷ page 36).
- ▶ Select and press the appropriate integrated signal transmitter button (②, ③ or ④) to activate the remote controlled device.

The integrated remote control transmitter continues to send the signal as long as the button is pressed – up to 20 seconds.

Useful features

Erasing the integrated remote control memory

- ▶ Switch on the ignition (▷ page 36).
- ▶ Simultaneously press and hold down the outer signal transmitter buttons ② and ④, for approximately 20 seconds, until the indicator lamp ① flashes rapidly. Do not hold for longer than 30 seconds.

The codes of all three channels are erased.



If you sell your vehicle, erase the codes of all three channels.

Programming tips

If you are having difficulty programming the integrated remote control, here are some helpful tips:

- Check the frequency of the hand-held remote control ⑤ (typically located on the reverse side of the remote). The integrated remote control is compatible with radio-frequency devices operating between 288-399 MHz.
- Put a new battery in the hand-held remote control ⑤. This will increase the likelihood of the hand-held remote control sending a faster and more accurate signal to the integrated remote control.
- While performing step 3, hold the hand-held remote control ⑥ at different lengths and angles from the signal transmitter button (②, ③ or ④) you are programming. Attempt varying angles at the distance of 2 to 5 inches (5 to 12 cm) away or the same angle at varying distances.
- If another hand-held remote control is available for the same device, try the programming steps again using that other hand-held remote control. Make sure new batteries are in the hand-held remote control before beginning the procedure.
- Straighten the antenna wire from the garage door opener assembly. This may help improve transmitting and/or receiving signals.



Certain types of garage door openers are incompatible with the integrated remote control. If you should experience further difficulties with programming the integrated remote control, contact an authorized Mercedes-Benz Center, or call Mercedes-Benz Customer Assistance Center (in the USA only) at 1-800-FOR-MERCEdes, or Customer Service (in Canada) at 1-800-387-0100.



USA only:
This device complies with Part 15 of the FCC Rules. Operation is subject to the following two conditions:

- (1) This device may not cause harmful interference, and
- (2) this device must accept any interference received, including interference that may cause undesired operation.

Any unauthorized modification to this device could void the user's authority to operate the equipment.



Canada only:
This device complies with RSS-210 of Industry Canada. Operation is subject to the following two conditions:

- (1) This device may not cause interference, and
- (2) this device must accept any interference received, including interference that may cause undesired operation of the device.

Any unauthorized modification to this device could void the user's authority to operate the equipment.

The first 1000 miles (1500 km)

Driving instructions

At the gas station

Engine compartment

Tires and wheels

Winter driving

Maintenance

Vehicle care



The first 1 000 miles (1 500 km)

In the “Operation” section you will find detailed information on operating, maintaining and caring for your vehicle.

The more cautiously you treat your vehicle during the break-in period, the more satisfied you will be with its performance later on.

- Drive your vehicle during the first 1 000 miles (1 500 km) at varying but moderate vehicle and engine speeds.
- During this period, avoid heavy loads (full throttle driving) and excessive engine speeds (no more than $\frac{2}{3}$ of maximum rpm in each gear).
- Shift gears in a timely manner.
- Avoid accelerating by kickdown.
- Do not attempt to slow the vehicle down by shifting to a lower gear using the gear selector lever.
- Select positions **3**, **2** or **1** only when driving at moderate speeds (for hill driving).
- Select mode **C** as the preferred shift program (▷ page 172) for the first 1 000 miles (1 500 km).

After 1 000 miles (1 500 km), you may gradually increase vehicle and engine speeds to the permissible maximum.



Additional instructions for AMG vehicles:

- During the first 1 000 miles (1 500 km), do not exceed a speed of 85 mph (140 km/h).
- During this period, avoid engine speeds above 4500 rpm in each gear.

All of the above instructions, as may apply to your vehicle type, also apply when driving the first 1 000 miles (1 500 km) after the engine or the rear differential has been replaced.



Always obey applicable speed limits.

▼ Driving instructions

Drive sensibly – save fuel

Fuel consumption, to a great extent, depends on driving habits and operating conditions.

To save fuel you should:

- Keep tires at the recommended tire inflation pressures.
- Remove unnecessary loads.
- Allow engine to warm up under low load use.
- Avoid frequent acceleration and deceleration.
- Have all maintenance work performed at the intervals specified in the Maintenance Booklet and as required by the Maintenance System (U.S. vehicles) or FSS (Canada vehicles). Contact an authorized Mercedes-Benz Center.

Fuel consumption is also increased by driving in cold weather, in stop-and-go traffic, on short trips and in hilly area.

Drinking and driving

Warning!



Drinking and driving and/or taking drugs and driving are very dangerous combinations. Even a small amount of alcohol or drugs can affect your reflexes, perceptions and judgment.

The possibility of a serious or even fatal accident are greatly increased when you drink or take drugs and drive.

Do not drink or take drugs and drive or allow anyone to drive who has been drinking or taking drugs.

Pedals

Warning!



Keep driver's foot area clear at all times. Objects stored in this area may impair pedal movement.

Power assistance

Warning!



With the engine not running, there is no power assistance for the brake and steering systems. In this case, it is important to keep in mind that a considerably higher degree of effort is necessary to brake and steer the vehicle.

Driving instructions

Brakes

Warning!



After driving in heavy rain for some time without applying the brakes or through water deep enough to wet brake components, the first braking action may be somewhat reduced and increased pedal pressure may be necessary to obtain expected braking effect. Maintain a safe distance from vehicles in front.

Resting your foot on the brake pedal will cause excessive and premature wear of the brake pads.

It can also result in the brakes overheating, thereby significantly reducing their effectiveness. It may not be possible to stop the vehicle in sufficient time to avoid an accident.

To help prevent brake disk corrosion after driving on wet road surfaces (particularly salted roads), it is advisable to brake the vehicle with considerable force prior to parking. The heat generated serves to dry the brakes.

If your brake system is normally only subject to moderate loads, you should occasionally test the effectiveness of the brakes by applying above-normal braking pressure at higher speeds. This will also enhance the grip of the brake pads.

Warning!



Make sure not to endanger any other road users when carrying out these braking maneuvers.

Refer to the description of the Brake Assist System (BAS) (▷ page 88).

If the parking brake is released and the brake warning lamp in the instrument cluster stays on, the brake fluid level in the reservoir is too low.

Brake pad wear or a leak in the system may be the reason for low brake fluid in the reservoir.

Have the brake system inspected immediately. Contact an authorized Mercedes-Benz Center.

All checks and service work on the brake system should be carried out by qualified technicians only. Contact an authorized Mercedes-Benz Center.

Only install brake pads and brake fluid recommended by Mercedes-Benz.

Warning!

If other than recommended brake pads are installed, or other than recommended brake fluid is used, the braking properties of the vehicle can be degraded to an extent that safe braking is substantially impaired. This could result in an accident.



When driving down long and steep grades, relieve the load on the brakes by shifting into a lower gear to use the engine's braking power. This helps prevent overheating of the brakes and reduces brake pad wear.

After hard braking, it is advisable to drive on for some time, rather than immediately park, so that the air stream can cool down the brakes faster.

High-performance brake system (CLK 55 AMG only)

The high-performance brake system is designed to operate under the extremely high operating demands required to accommodate the performance capabilities of the vehicle. The brakes may produce a squeaking-type noise depending on the

- vehicle speed
- brake force applied
- ambient conditions, e.g. temperature and humidity

As with any brake system, the wear of individual brake system components such as brake pads or discs strongly depends on your driving style and the conditions under which you operate the vehicle. Thus, a driving style calling for high demand braking will cause your vehicle's brakes to wear more quickly.

Warning!

New vehicle brake pads and discs, and replacement brake pads and discs may take several hundred miles of driving until they provide optimum braking efficiency. Until that time, you may need to use increased brake pedal pressure while braking. Please be aware of this and adjust your driving and braking accordingly during this break-in period.

Excessive high demand braking will cause correspondingly high brake wear. Please be attentive to the brake warning lamp in the instrument cluster and brake condition messages in the multifunction display. Especially for high performance driving, it is important to maintain the brake system and have it checked regularly.

Driving instructions

Driving off

Apply the brakes to test them briefly after driving off. Perform this procedure only when the road is clear of other traffic.

Warm up the engine gradually. Do not place full load on the engine until the operating temperature has been reached.

When starting off on a slippery surface, do not allow a drive wheel to spin for an extended period with the ESP® switched off. Doing so may cause serious damage to the drivetrain which is not covered by the Mercedes-Benz Limited Warranty.



Simultaneously depressing the accelerator pedal and applying the brake reduces engine performance and causes premature brake wear and drivetrain wear.

Parking



Set the parking brake whenever parking or leaving the vehicle. In addition, move gear selector lever to position **P**. When parking on hills, turn front wheels towards the road curb.

Warning!



Do not park this vehicle in areas where combustible materials such as grass, hay or leaves can come into contact with the hot exhaust system, as these materials could be ignited and cause a vehicle fire.

Warning!



To reduce the risk of personal injury as a result of inadvertent vehicle movement, before turning off the engine and leaving the vehicle always:

- Keep right foot firmly on brake pedal.
- Firmly depress parking brake pedal.
- Move the gear selector lever to position **P**.
- Slowly release brake pedal.
- When parked on an incline, turn front wheels towards the road curb.
- Turn the SmartKey in the starter switch to position **0** and remove the SmartKey from the starter switch, or press KEYLESS-GO* start/stop button (vehicles with KEYLESS-GO*).
- Take the SmartKey or the SmartKey with KEYLESS-GO* with you and lock vehicle when leaving.

Tires

Warning!



If you feel a sudden significant vibration or ride disturbance, or you suspect that possible damage to your vehicle has occurred, you should turn on the hazard warning flashers, carefully slow down, and drive with caution to an area which is a safe distance from the road.

Inspect the tires and the vehicle underbody for possible damage. If the vehicle or tires appear unsafe, have the vehicle towed to the nearest Mercedes-Benz Center or tire dealer for repairs.

Treadwear indicators (TWI) are required by law. These indicators are located in six places on the tread circumference and become visible at a tread depth of approximately $1/16$ in (1.6 mm), at which point the tire is considered worn and should be replaced.

The treadwear indicator appears as a solid band across the tread.

Warning!



Although the applicable federal motor vehicle safety laws consider a tire to be worn when the treadwear indicators (TWI) become visible at approximately $1/16$ in (1.6 mm), we recommend that you do not allow your tires to wear down to that level. As tread depth approaches $1/8$ in (3 mm), the adhesion properties on a wet road are sharply reduced.

Depending upon the weather and/or road surface (conditions), the tire traction varies widely.

Specified tire inflation pressures must be maintained. This applies particularly if the tires are subject to extreme operating conditions (e.g. high speeds, heavy loads, high ambient temperatures).

Warning!



Do not drive with a flat tire. A flat tire affects the ability to steer or brake the vehicle. You may lose control of the vehicle. Continued driving with a flat tire or driving at high speed with a flat tire will cause excessive heat build-up and possibly a fire.

Hydroplaning

Depending on the depth of the water layer on the road, hydroplaning may occur, even at low speeds and with new tires. Reduce vehicle speed, avoid track grooves in the road and apply brakes cautiously in the rain.

Driving instructions

Tire traction

The safe speed on a wet, snow covered or icy road is always lower than on a dry road.

You should pay particular attention to the condition of the road whenever the outside temperatures are close to the freezing point.

Warning!



If ice has formed on the road, tire traction will be substantially reduced. Under such weather conditions, drive, steer and brake with extreme caution.

Mercedes-Benz recommends winter tires (▷ page 359) with a minimum tread depth of approximately $\frac{1}{6}$ in (4 mm) on all four wheels for the winter season to ensure normal balanced handling characteristics. On packed snow, they can reduce your stopping distance compared to summer tires. Stopping distance, however, is still considerably greater than when the road is not covered with snow or ice. Exercise appropriate caution.



Avoid spinning of a drive wheel. This may cause serious damage to the drivetrain which is not covered by the Mercedes-Benz Limited Warranty.

Tire speed rating

Regardless of the tire speed rating, local speed limits should be obeyed. Use prudent driving speeds appropriate to prevailing conditions.

Warning!



Even when permitted by law, never operate a vehicle at speeds greater than the maximum speed rating of the tires.

Exceeding the maximum speed for which tires are rated can lead to sudden tire failure, causing loss of vehicle control and possibly resulting in an accident and/or personal injury and possible death, for you and for others.

CLK 350, CLK 500

Your vehicle is factory equipped with “W”-rated tires, which have a speed rating of 168 mph (270 km/h).

An electronic speed limiter prevents your vehicle from exceeding a speed of 130 mph (210 km/h).

CLK 55 AMG

Your vehicle is factory equipped with “Y”-rated tires, which have a speed rating of 186 mph (300 km/h).

An electronic speed limiter prevents your vehicle from exceeding a speed of 155 mph (250 km/h).



For information on tire speed rating for winter tires, see “Winter tires” (▷ page 359).

For additional general information on tire speed markings on the sidewall, see “Tire speed rating” (▷ page 346).

Winter driving instructions

The most important rule for slippery or icy roads is to drive sensibly and to avoid abrupt acceleration, braking and steering maneuvers. Do not use the cruise control system under such conditions.

When the vehicle is in danger of skidding, move gear selector lever to position **N**. Try to keep the vehicle under control by corrective steering action.



For information on driving with snow chains, see “Snow chains” (▷ page 360).

Warning!

On slippery road surfaces, never downshift in order to obtain braking action. This could result in drive wheel slip and reduced vehicle control. Your vehicle’s ABS will not prevent this type of control loss.

Road salts and chemicals can adversely affect braking efficiency. Increased pedal force may become necessary to produce the normal braking effect.

Depressing the brake pedal periodically when traveling at length on salt-strewn roads can bring road-salt-impaired braking efficiency back to normal.

If the vehicle is parked after being driven on salt-treated roads, the braking efficiency should be tested as soon as possible after driving is resumed.

Warning!

Make sure not to endanger any other road users when carrying out these braking maneuvers.

Driving instructions

Warning!



If the vehicle becomes stuck in snow, make sure snow is kept clear of the exhaust pipe and from around the vehicle with the engine running. Otherwise, deadly carbon monoxide (CO) gases may enter vehicle interior resulting in unconsciousness and death.

To assure sufficient fresh air ventilation, open a window slightly on the side of the vehicle not facing the wind.

Warning!



The outside temperature indicator is not designed to serve as an ice-warning device and is therefore unsuitable for that purpose. Indicated temperatures just above the freezing point do not guarantee that the road surface is free of ice.

For more information, see “Winter driving” (▷ page 359).

Standing water



Do not drive through flooded areas or water of unknown depth. Before driving through water, determine its depth. Never accelerate before driving into water. The bow wave could force water into the engine and auxiliary equipment, thus damaging them.

If you must drive through standing water, drive slowly to prevent water from entering the passenger compartment or the engine compartment. Water in these areas could cause damage to electrical components or wiring of the engine or transmission, or could result in water being ingested by the engine through the air intake, causing severe internal engine damage. Any such damage is not covered by the Mercedes-Benz Limited Warranty.

Passenger compartment

Warning!



Always fasten items being carried as securely as possible.

In an accident, during hard braking or sudden maneuvers, loose items will be thrown around inside the vehicle, and cause injury to vehicle occupants unless the items are securely fastened in the vehicle.

The trunk is the preferred place to carry objects.

Driving abroad

Abroad, there is an extensive Mercedes-Benz service network at your disposal. If you plan to drive into areas which are not listed in the index of your Mercedes-Benz Center directory, you should request pertinent information from an authorized Mercedes-Benz Center.

Control and operation of radio transmitters

COMAND*, radio and telephone*

Warning!



Please do not forget that your primary responsibility is to drive the vehicle safely. Only operate the COMAND (Cockpit Management and Data System), radio or telephone¹ if road, weather and traffic conditions permit.

Bear in mind that at a speed of just 30 mph (approximately 50 km/h), your vehicle is covering a distance of 44 feet (approximately 14 m) every second.

¹ Observe all legal requirements.

Telephones* and two-way radios

Warning!



Never operate radio transmitters equipped with a built-in or attached antenna (i.e. without being connected to an external antenna) from inside the vehicle while the engine is running. Doing so could lead to a malfunction of the vehicle's electronic system, possibly resulting in an accident and/or serious personal injury.

Radio transmitters, such as a portable telephone or a citizens band unit should only be used inside the vehicle if they are connected to an antenna that is installed on the outside of the vehicle.

Refer to the radio transmitter operation instructions regarding use of an external antenna.

Driving instructions

Catalytic converter

Your Mercedes-Benz is equipped with monolithic-type catalytic converters, an important element in conjunction with the oxygen sensors to achieve substantial control of the pollutants in the exhaust emissions. Keep your vehicle in proper operating condition by following our recommended maintenance instructions as outlined in your Maintenance Booklet.



To prevent damage to the catalytic converters, only use premium unleaded gasoline in this vehicle.

Any noticeable irregularities in engine operation should be repaired promptly. Otherwise, excessive unburned fuel may reach the catalytic converter, causing it to overheat and potentially start a fire.

Warning!



As with any vehicle, do not idle, park or operate this vehicle in areas where combustible materials such as grass, hay, or leaves can come into contact with the hot exhaust system, as these materials could be ignited and cause a vehicle fire.

Emission control

Certain systems of the engine serve to keep the toxic components of the exhaust gases within permissible limits required by law.

These systems, of course, will function properly only when maintained strictly according to factory specifications. Any adjustments to the engine should therefore be carried out only by qualified Mercedes-Benz Center authorized technicians.

Engine adjustments should not be altered in any way. Moreover, the specified service jobs must be carried out regularly according to Mercedes-Benz servicing requirements. For details refer to the Maintenance Booklet.

Warning!

Inhalation of exhaust gas is hazardous to your health. All exhaust gas contains carbon monoxide (CO), and inhaling it can cause unconsciousness and lead to death.

Do not run the engine in confined areas (such as a garage) which are not properly ventilated. If you think that exhaust gas fumes are entering the vehicle while driving, have the cause determined and corrected immediately. If you must drive under these conditions, drive with at least one window fully open at all times.

Coolant temperature

During severe operating conditions and stop-and-go city traffic, the coolant temperature may rise close to approximately 248°F (120°C).

The engine should not be operated with the coolant temperature over 248°F (120°C). Doing so may cause serious engine damage which is not covered by the Mercedes-Benz Limited Warranty.

Warning!

- Driving when your engine is badly overheated can cause some fluids, which may have leaked into the engine compartment, to catch fire. You could be seriously burned.
- Steam from an overheated engine can cause serious burns and can occur just by opening the hood. Stay away from the engine if you see or hear steam coming from it.

Turn off the engine, get out of the vehicle and do not stand near the vehicle until the engine has cooled down.

At the gas station

Refueling

Warning!



Gasoline is highly flammable and poisonous. It burns violently and can cause serious injury. Whenever you are around gasoline, avoid inhaling fumes and skin contact, extinguish all smoking materials. Never allow sparks, flame or smoking materials near gasoline!

Failure to remove the fuel cap slowly could result in personal injury.

The fuel filler flap is located on the right-hand side of the vehicle towards the rear. Locking/unlocking the vehicle with the SmartKey or the SmartKey with KEYLESS-GO* automatically locks/unlocks the fuel filler flap.



- ① To open the fuel filler flap
- ② To insert the fuel filler cap

- ▶ Turn the engine off
 - by turning the SmartKey to position **0**. Remove the SmartKey from the starter switch.
 - by pressing the KEYLESS-GO* start/stop button. Open the driver's door (with driver's door open, starter switch is now in position **0**, same as with SmartKey removed from starter switch).

- ▶ Open the fuel filler flap by pushing at the point indicated by the arrow ①. The fuel filler flap springs open.
- ▶ Turn fuel cap counterclockwise and hold on to it until possible pressure is released.
- ▶ Take off cap and set it in direction of arrow ② in the recess on the fuel filler flap.

To prevent fuel vapors from escaping into open air, fully insert filler nozzle unit.

- ▶ Only fill your tank until the filler nozzle unit cuts out – **do not top up or overfill.**

Warning!

Overfilling of the fuel tank may create pressure in the system which could cause a gas discharge. This could cause the gas to spray back out when removing the fuel pump nozzle, which could cause personal injury.

- ▶ Replace fuel cap by turning it clockwise until it audibly engages.
- ▶ Close fuel filler flap.





Only use premium unleaded gasoline with a minimum Posted Octane Rating of 91 (average of 96 RON / 86 MON).

Information on gasoline quality can normally be found on the fuel pump.

For more information on gasoline, see “Premium unleaded gasoline” (▷ page 482) or the Factory Approved Service Products pamphlet.



Leaving the engine running and the fuel cap open can cause the  malfunction indicator lamp (USA only) or the  malfunction indicator lamp (Canada only) to illuminate.

More information can be found in the “Practical hints” section (▷ page 376).

At the gas station

Check regularly and before a long trip



Engine compartment (CLK 500, example)

- ① Coolant level
- ② Brake fluid (fuse box cover removed)
- ③ Windshield washer and headlamp cleaning system*



Opening the hood, see (▷ page 321).

Coolant

For normal replenishing, use water (potable water quality). For more information, see “Coolant” (▷ page 327) and see “Fuels, coolants, lubricants, etc.” (▷ page 479).

Brake fluid

Removing fuse box cover (▷ page 463).



If you find that the brake fluid in the brake fluid reservoir has fallen to the minimum mark or below, have the brake system checked for brake pad thickness and leaks immediately. Notify an authorized Mercedes-Benz Center immediately. Do not add brake fluid as this will not solve the problem. For more information, see also “Practical hints” (▷ page 375).

Windshield washer and headlamp cleaning system*

For more information on filling up the washer reservoir, see “Windshield washer system and headlamp cleaning system*” (▷ page 329).

Engine oil level

For more information on engine oil, see “Engine oil” (▷ page 322).

Vehicle lighting

Check function and cleanliness. For more information on replacing light bulbs, see “Replacing bulbs” (▷ page 438).

For more information, see “Exterior lamp switch” (▷ page 52).

Tire inflation pressure

For more information, see “Recommended tire inflation pressure” (▷ page 339).

▼ Engine compartment

Hood

Warning!



Do not pull the release lever while the vehicle is in motion. Otherwise the hood could be forced open by passing air flow.

Opening

The hood lock release lever is located to the left of the steering wheel under the dashboard.



① Hood lock release lever

- ▶ Pull lever ① downwards.
The hood is unlocked.



To avoid damage to the windshield wipers or hood, never open the hood if the wiper arms are folded forward away from the windshield.

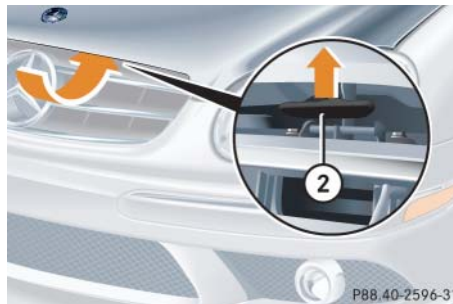

② Lever for opening the hood

- ▶ Push lever ② on the hood upwards.
- ▶ Pull up on the hood and then release it.

The hood will be automatically held open at shoulder height by gas-filled struts.

Warning!



To help prevent personal injury, stay clear of moving parts when the hood is open and the engine is running. Make sure the hood is properly closed before driving. When closing the hood, use extreme caution not to catch hands or fingers.

The radiator fan may continue to run for approximately 30 seconds or even restart after the engine has been turned off. Stay clear of fan blades.



Engine compartment



Warning!



If you see flames or smoke coming from the engine compartment, or if the coolant temperature gauge indicates that the engine is overheated, do not open the hood. Move away from vehicle and do not open the hood until the engine has cooled. If necessary, call the fire department.

Warning!



The engine is equipped with a transistorized ignition system. Because of the high voltage it is dangerous to touch any components (ignition coils, spark plug sockets, diagnostic socket) of the ignition system

- with the engine running
- while starting the engine
- if ignition is “on” and the engine is turned manually

Closing

Warning!



Be careful that you do not close the hood on anyone.

- ▶ Let the hood drop from a height of approximately 1 ft (30 cm).

The hood will lock audibly.

- ▶ Check to make sure the hood is fully closed.

If you can raise the hood at a point above the headlamps, then it is not properly closed. Open it again and let it drop with somewhat greater force.

Engine oil

The amount of oil your engine needs will depend on a number of factors, including driving style. Higher oil consumption can occur when

- the vehicle is new
- the vehicle is driven frequently at higher engine speeds

Engine oil consumption checks should only be made after the vehicle break-in period.



Do not use any special lubricant additives, as these may damage the drive assemblies. Using special additives not approved by Mercedes-Benz may cause damage not covered by the Mercedes-Benz Limited Warranty. More information on this subject is available at any Mercedes-Benz Center.

Checking engine oil level with the control system



When checking the oil level

- the vehicle must be parked on level ground
- with the engine at operating temperature, the vehicle must have been stationary for at least 5 minutes with the engine turned off
- with the engine not at operating temperature yet, the vehicle must have been stationary for at least 30 minutes with the engine turned off

To check the engine oil level via the multifunction display, do the following:

- ▶ Switch on the ignition (▷ page 34).

The standard display (▷ page 144) should appear in the multifunction display.



- ▶ Press button  or  on the multifunction steering wheel until the following message is seen in the multifunction display:



One of the following messages will subsequently appear in the multifunction display:

- Engine oil level ok
- Add 1.0 qt.
to reach max. oil level
(Canada: 1.0 liter)
- Add 1.5 qt.
to reach max. oil level
(Canada: 1.5 liter)
- Add 2.0 qt.
to reach max. oil level
(Canada: 2.0 liter)



If you want to interrupt the checking procedure, press the  or  button on the multifunction steering wheel.

- ▶ If necessary, add engine oil.

For adding engine oil, see (▷ page 325).

For more information on engine oil, see the “Technical data” section (▷ page 479) and (▷ page 481).

Other display messages

If the SmartKey is not turned to position **2** in the starter switch, the following message will appear:

Turn on ignition
to see engine oil level

- ▶ Switch on the ignition (▷ page 36).

Engine compartment

If you see the message:

Observe waiting time

- ▶ If engine is at operating temperature, wait 5 minutes before repeating check procedure.
- ▶ If engine is not at operating temperature yet, wait 30 minutes before repeating check procedure.

If you see the message:

Engine oil level

Not when engine on

- ▶ Turn off the engine.
- ▶ If the engine is at operating temperature, wait 5 minutes before checking oil.
- ▶ If the engine is not at operating temperature yet, you must wait 30 minutes before checking oil.

If there is excess engine oil with the engine at operating temperature, the following message will appear:

Engine oil level

Reduce oil level

- ▶ Have excess oil siphoned or drained off. Contact an authorized Mercedes-Benz Center.



Excess oil must be siphoned or drained off. It could cause damage to the engine and catalytic converter not covered by the Mercedes-Benz Limited Warranty.

For more information on messages in the multifunction display concerning engine oil, see the “Practical hints” section (▷ page 401).

Checking engine oil level with the oil dipstick, CLK 350

When checking the oil level

- the vehicle must be parked on level ground.
- with the engine at operating temperature, the vehicle must have been stationary for at least 5 minutes with the engine turned off.
- with the engine not at operating temperature yet, the vehicle must have been stationary for at least 30 minutes with the engine turned off.

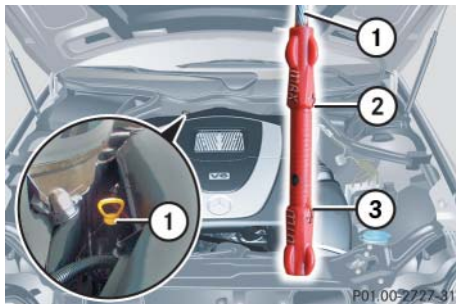

- ① Oil dipstick
- ② Upper (max) mark
- ③ Lower (min) mark

To check the engine oil level with the oil dipstick, do the following:

- ▶ Open the hood (▷ page 321).
- ▶ Pull out oil dipstick ①.
- ▶ Wipe oil dipstick ① clean.
- ▶ Fully insert oil dipstick ① into the dipstick guide tube.

- ▶ Pull out oil dipstick ① again after approximately 3 seconds to obtain accurate reading.

The oil level is correct when it is between the lower (min) mark ③ and upper (max) mark ② of oil dipstick ①.



The filling quantity between the upper and lower marks on the oil dipstick is approximately 2.1 US qt. (2.0 l).

- ▶ If necessary, add engine oil.

For adding engine oil, see “Adding engine oil” (▷ page 325).

For more information on engine oil, see “Fuels, coolants, lubricants, etc.” (▷ page 479).

For more information on messages in the multifunction display concerning engine oil, see the “Practical hints” section (▷ page 401).

Adding engine oil



Only use approved engine oils and oil filters required for vehicles with Maintenance System (U.S. vehicles) or FSS (Canada vehicles). For a listing of approved engine oils and oil filters, refer to the Factory Approved Service Products pamphlet in your vehicle literature portfolio, or contact an authorized Mercedes-Benz Center.

Using engine oils and oil filters of specification other than those expressly required for the Maintenance System (U.S. vehicles) or FSS (Canada vehicles), or changing of oil and oil filter at change intervals longer than those called for by the Maintenance System (U.S. vehicles) or FSS (Canada vehicles) will result in engine damage not covered by the Mercedes-Benz Limited Warranty.

Engine compartment



CLK 350

① Filler cap



CLK 500, CLK 55 AMG

① Filler cap

- ▶ Unscrew filler cap ① from filler neck.
- ▶ Add engine oil as required. Be careful not to overfill with oil.

Be careful not to spill any oil when adding. Avoid environmental damage caused by oil entering the ground or water.



Excess oil must be siphoned or drained off. It could cause damage to the engine and catalytic converter not covered by the Mercedes-Benz Limited Warranty.

- ▶ Screw filler cap ① back on filler neck.

More information on engine oil can be found in the “Technical data” section (▷ page 479) and (▷ page 481).

Transmission fluid level

The transmission fluid level does not need to be checked. If you notice transmission fluid loss or gear shifting malfunctions, have an authorized Mercedes-Benz Center check the automatic transmission.

Coolant

The engine coolant is a mixture of water and anticorrosion/antifreeze. To check the coolant level, the vehicle must be parked on level ground and the engine must be cool.

The coolant expansion tank is located on the passenger side of the engine compartment.

Warning!



In order to avoid any possibly serious burns:

- Use extreme caution when opening the hood if there are any signs of steam or coolant leaking from the cooling system, or if the coolant temperature gauge indicates that the coolant is overheated.
- Do not remove pressure cap on coolant reservoir if the coolant temperature is above 158°F (70°C). Allow the coolant to cool down before removing cap. The coolant reservoir contains hot fluid and is under pressure.

- Using a rag, slowly open the cap approximately $1/2$ turn to relieve excess pressure. If opened immediately, scalding hot fluid and steam will be blown out under pressure.
- Do not spill antifreeze on hot engine parts. Antifreeze contains ethylene glycol which may burn if it comes into contact with hot engine parts.

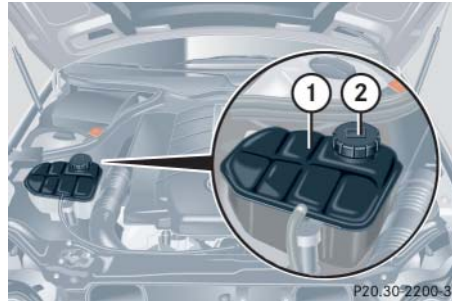

- ① Coolant expansion tank
- ② Cap

- ▶ Using a rag, turn cap ② slowly approximately one half turn to the left to release any excess pressure.
- ▶ Continue turning the cap ② to the left and remove it.

The coolant level is correct if the level

- for cold coolant: reaches the marking (plastic bridge) inside the reservoir
- for warm coolant: is approx. 0.6 in (1.5 cm) higher
- ▶ Add coolant as required.
- ▶ Replace and tighten cap ②.

More information on coolant can be found in the “Technical data” section (▷ page 484).

Engine compartment

Battery





Your vehicle's battery is located in the engine compartment on the right-hand side (▷ page 453).



The battery should always be sufficiently charged in order to achieve its rated service life. Refer to Maintenance Booklet for battery maintenance intervals.

If you use your vehicle mostly for short-distance trips, you will need to have the battery charge checked more frequently.

When replacing the battery, always use batteries approved by Mercedes-Benz.

If you do not intend to operate your vehicle for an extended period of time, consult an authorized Mercedes-Benz Center about steps you need to observe.

	Observe all safety instructions and precautions when handling automotive batteries.
	Risk of explosion.
	Keep flames or sparks away from battery. Do not smoke.
	Battery acid is caustic. Do not allow it to come into contact with skin, eyes or clothing. In case it does, immediately flush affected area with clean water and seek medical help if necessary.

	Wear eye protection.
	Keep children away.
	Follow the instructions in this Operator's Manual.

Batteries contain materials that can harm the environment if disposed of improperly. Recycling of batteries is the preferred method of disposal. Many states require sellers of batteries to accept old batteries for recycling.

Windshield washer system and headlamp cleaning system*

The windshield washer reservoir is located in the engine compartment.

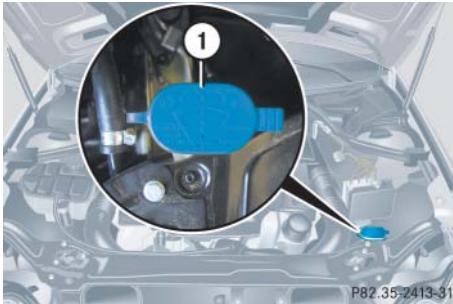

① Washer fluid reservoir cap

Fluid for the windshield washer system and the headlamp cleaning system is supplied from the windshield washer reservoir. It has a capacity of approx. 6.4 US qt (6 l).

During all seasons, add MB Windshield Washer Concentrate “S” to water. Premix the windshield washer fluid in a suitable container.

Warning!



Washer solvent/antifreeze is highly flammable. Do not spill washer solvent/antifreeze on hot engine parts, because it may ignite and burn. You could be seriously burned.

- ▶ Refill the reservoir with MB Windshield Washer Concentrate “S” and water (or commercially available premixed windshield washer solvent/antifreeze, depending on ambient temperatures).

Always use washer solvent/antifreeze where temperatures may fall below the freezing point. Failure to do so could result in damage to the washer system/reservoir.



Only use washer fluid which is suitable for plastic lenses. Improper washer fluid can damage the plastic lenses of the headlamps.

For more information, see “Windshield washer system and headlamp cleaning system*” (▷ page 486).

Tires and wheels

See an authorized Mercedes-Benz Center for information on tested and recommended rims and tires for summer and winter operation. They can also offer advice concerning tire service and purchase.

Warning!



Replace rims or tires with the same designation, manufacturer and type as shown on the original part. See an authorized Mercedes-Benz Center for further information. If incorrectly sized rims and tires are mounted:

- The wheel brakes or suspension components can be damaged.
- The operating clearance of the wheels and the tires may no longer be correct.

Warning!



Worn, old tires can cause accidents. If the tire tread is badly worn, or if the tires have sustained damage, replace them.

When replacing rims, only use Genuine Mercedes-Benz wheel bolts specified for the particular rim type. Failure to do so can result in the bolts loosening and possibly an accident.

Retreaded tires are not tested or recommended by Mercedes-Benz, since previous damage cannot always be recognized on retreads. The operating safety of the vehicle cannot be assured when such tires are used.

Important guidelines

- Only use sets of tires and rims of the same type and make.
- Tires must be of the correct size for the rim.
- Break in new tires for approximately 60 miles (100 km) at moderate speeds.
- Regularly check the tires and rims for damage. Dented or bent rims can cause tire inflation pressure loss and damage to the tire beads.
- If vehicle is heavily loaded, check tire inflation pressure and correct as required.
- Do not allow your tires to wear down too far. Adhesion properties on wet roads are sharply reduced at tread depths under $\frac{1}{8}$ in (3 mm).
- When replacing individual tires, you should mount new tires on the front wheels first (on vehicles with same-sized wheels all around).

Tire care and maintenance

Warning!



Regularly check the tires for damage. Damaged tires can cause tire inflation pressure loss. As a result, you could lose control of your vehicle.

Worn, old tires can cause accidents. If the tire tread is badly worn, or if the tires have sustained damage, replace them.

Regularly check your tire inflation pressure at least once a month. For more information on checking tire inflation pressure see “Recommended tire inflation pressure” (▷ page 339).

Tire inspection

Every time you check your tire inflation pressure, you should also inspect your tires for the following:

- excessive treadwear (▷ page 332)
- cord or fabric showing through the tire’s rubber
- bumps, bulges, cuts, cracks or splits in the tread or side of the tire

Replace the tire if you find any of the above conditions.

Make sure you also inspect the spare tire periodically for condition and inflation. Spare tires will age and become worn over time even if never used, and thus should be inspected and replaced when necessary.

Life of tire

The service life of a tire is dependent upon varying factors including but not limited to:

- Driving style
- Tire inflation pressure
- Distance driven

Warning!



Tires and spare tire should be replaced after six years, regardless of the remaining tread.

Tires and wheels

Tread depth

Do not allow your tires to wear down too far. Adhesion properties on wet roads are sharply reduced at tread depths under $\frac{1}{8}$ in (3 mm).

Treadwear indicators (TWI) are required by law. These indicators are located in six places on the tread circumference and become visible at a tread depth of approximately $\frac{1}{16}$ in (1.6 mm), at which point the tire is considered worn and should be replaced.

Recommended minimum tire tread depth:

- Summer tires $\frac{1}{8}$ in (3 mm)
- Winter tires $\frac{1}{6}$ in (4 mm)

Warning!



Although the applicable federal motor safety laws consider a tire to be worn when the treadwear indicators (TWI) become visible at approximately $\frac{1}{16}$ in (1.6 mm), we recommend that you do not allow your tires

to wear down to that level. As tread depth approaches $\frac{1}{8}$ in (3 mm), the adhesion properties on a wet road are sharply reduced.

Depending upon the weather and/or road surface (conditions), the tire traction varies widely.

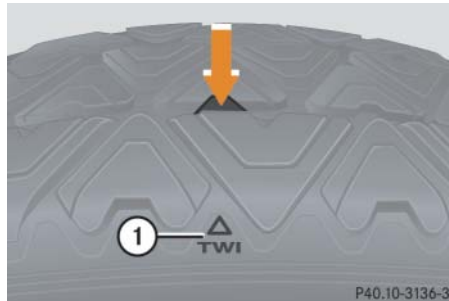

① TWI (Tread Wear Indicator)

The treadwear indicator appears as a solid band across the tread.

Storing tires



Keep unmounted tires in a cool, dry place with as little exposure to light as possible. Protect tires from contact with oil, grease and gasoline.

Cleaning tires



Never use a round nozzle to power wash tires. The intense jet of water can result in damage to the tire.

Always replace a damaged tire.

Direction of rotation

Unidirectional tires offer added advantages, such as better hydroplaning performance. To benefit, however, you must make sure the tires rotate in the direction specified.

An arrow on the sidewall indicates the intended direction of rotation (spinning) of the tire.



Spare wheels may be mounted against the direction of rotation (spinning) even with a unidirectional tire for temporary use only until the regular drive wheel has been repaired or replaced. Always observe and follow applicable temporary use restrictions and speed limitations indicated on the spare wheel.

Loading the vehicle

Two labels on your vehicle show how much weight it may properly carry.

- The Tire and Loading Information placard (Example A) or the Vehicle Tire Information placard (Example B) can be found on the driver's door B-pillar. This placard tells you important information about the number of people that can be in the vehicle and the total weight that can be carried in the vehicle. It also contains information on the proper size and recommended tire inflation pressures for the original equipment tires on your vehicle.
- The Certification label, also found on the driver's door B-pillar tells you about the gross weight capacity of your vehicle, called the Gross Vehicle Weight Rating (GVWR). The GVWR includes the weight of the vehicle, all occupants, fuel and cargo. The Certification label also tells you about

the front and rear axle weight capacity, called the Gross Axle Weight Rating (GAWR). The GAWR is the total allowable weight that can be carried by a single axle (front or rear). Never exceed the GVWR or GAWR for either the front axle or rear axle.

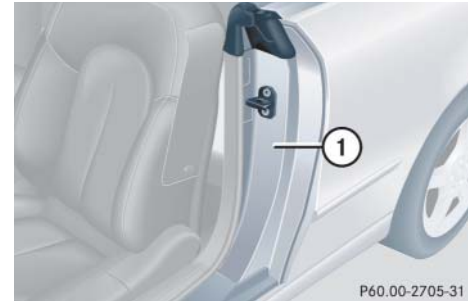

① Driver's door B-pillar

Following is a discussion on how to work with the information contained on the two placards with regards to loading your vehicle.

Tires and wheels

Tire and Loading Information

Warning!



Do not overload the tires by exceeding the specified load limit or vehicle capacity weight as indicated on the placard on the driver's door B-pillar. Overloading the tires can overheat them, possibly causing a blowout. Overloading the tires can also result in handling or steering problems, or brake failure.

Your vehicle is equipped with either the Tire and Loading Information placard (Example A) or the Vehicle Tire Information placard (Example B).



Data shown on placard examples are for illustration purposes only. Load limit data is specific to each vehicle and may vary from data shown in the illustrations below. Refer to placard on vehicle for actual data specific to your vehicle.

Placard (Example A)

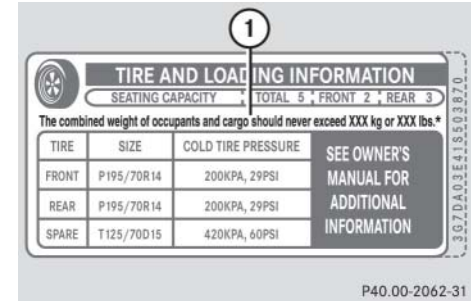

① Load limit information on the Tire and Loading Information placard

The placard showing the load limit information is located on the driver's door B-pillar. If your vehicle is equipped with the Tire and Loading Information placard (Example A), locate the statement "The combined weight of occupants and cargo should never exceed XXX kilograms or XXX lbs." on this placard. The combined weight of all occupants, cargo / luggage and trailer tongue load (if applicable) should never exceed the weight referenced in that statement.

Placard (Example B)

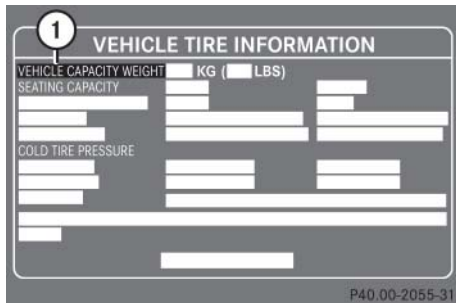

- ① Load limit information on the Vehicle Tire Information placard

The placard showing the load limit information is located on the driver’s door B-pillar. If your vehicle is equipped with the Vehicle Tire Information placard (Example B), locate the heading “Vehicle Capacity Weight” on this placard. The combined weight of all occupants, cargo/luggage and trailer tongue (if applicable) should never exceed the weight listed next to vehicle capacity weight.

Seating capacity

The seating capacity gives you important information on the number of occupants that can be in the vehicle. Observe front and rear seating capacity. Your vehicle is equipped with either placard Example A or placard Example B located on the driver’s door B-pillar (▷ page 333).



Data shown on placard examples are for illustration purposes only. Seating data is specific to each vehicle and may vary from data shown in the illustrations below. Refer to placard on vehicle for actual data specific to your vehicle.

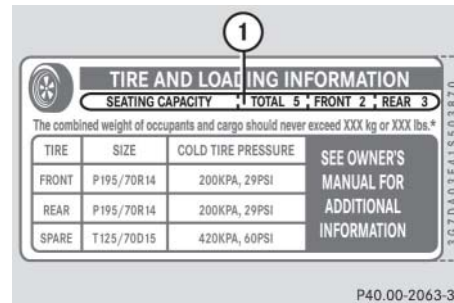

Placard (Example A)

- ① Seating capacity

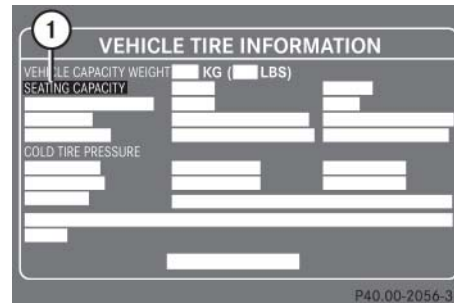

Placard (Example B)

- ① Seating capacity

Tires and wheels

Steps for determining correct load limit

The following steps have been developed as required of all manufacturers under Title 49, Code of U.S. Federal Regulations, Part 575 pursuant to the “National Traffic and Motor Vehicle Safety Act of 1966”.

Step 1 (Vehicles equipped with placard Example A)

- ▶ Locate the statement “The combined weight of occupants and cargo should never exceed XXX kg or XXX lbs.” on your vehicle’s placard.

Step 1 (Vehicles equipped with placard Example B)

- ▶ Locate the heading “Vehicle Capacity Weight” on your vehicle’s placard.

Step 2

- ▶ Determine the combined weight of the driver and passengers that will be riding in your vehicle.

Step 3

- ▶ Subtract the combined weight of the driver and passengers from XXX kilograms or XXX lbs.

Step 4

- ▶ The resulting figure equals the available amount of cargo and luggage load capacity. For example, if the “XXX” amount equals 1400 lbs and there will be five 150 lbs passengers in your vehicle, the amount of available cargo and luggage load capacity is 650 lbs. $(1400 - 750 (5 \times 150) = 650 \text{ lbs})$

Step 5

- ▶ Determine the combined weight of luggage and cargo being loaded on the vehicle. That weight may not safely exceed the available cargo and luggage load capacity calculated in step 4.

Step 6 (if applicable)

- ▶ If your vehicle will be towing a trailer, load from your trailer will be transferred to your vehicle. Consult this manual to determine how this reduces the available cargo and luggage load capacity of your vehicle (▷ page 338).

The following table shows examples on how to calculate total and cargo load capacities with varying seating configurations and number and size of occupants. The following examples use a load limit of 1500 lbs. **This is for illustration purposes only.** Make sure you are using the actual load limit for your vehicle stated on the vehicle’s placard (▷ page 334).

Example	Combined weight limit of occupants and cargo from placard	Number of occupants (driver and passengers)	Seating configuration	Occupants weight	Combined weight of all occupants	Available cargo/luggage and trailer tongue weight (total load limit or vehicle capacity weight from placard minus combined weight of all occupants)
1	1500 lbs	4	front: 2 rear: 2	Occupant 1: 150 lbs Occupant 2: 180 lbs Occupant 3: 160 lbs Occupant 4: 140 lbs	630 lbs	1500 lbs - 630 lbs = 870 lbs
2	1500 lbs	3	front: 1 rear: 2	Occupant 1: 200 lbs Occupant 2: 190 lbs Occupant 3: 150 lbs	540 lbs	1500 lbs - 540 lbs = 960 lbs
3	1500 lbs	1	front: 1	Occupant 1: 150 lbs	150 lbs	1500 lbs - 150 lbs = 1350 lbs

The higher the weight of all occupants, the less cargo and luggage load capacity is available.

For more information, see “Trailer tongue load” (> page 338).

Tires and wheels

Certification label

Even after careful determination of the combined weight of all occupants, cargo and the trailer tongue load (if applicable) (▷ page 338) as to not exceed the permissible load limit, you must make sure that your vehicle never exceeds the Gross Vehicle Weight Rating (GVWR) and the Gross Axle Weight Rating (GAWR) for either the front or rear axle. You can obtain the GVWR and GAWR from the Certification label. The Certification Label can be found on the driver's door B-pillar, see "Technical data" (▷ page 468).

Gross Vehicle Weight Rating (GVWR): The total weight of the vehicle, all occupants, all cargo, and the trailer tongue load (▷ page 338) must never exceed the GVWR.

Gross Axle Weight Rating (GAWR): The total allowable weight that can be carried by a single axle (front or rear).

To assure that your vehicle does not exceed the maximum permissible weight limits (GVWR and GAWR for front and rear axle), have the loaded vehicle (including driver, passengers and all cargo and, if applicable, trailer fully loaded) weighed on a suitable commercial scale.

Trailer tongue load

The tongue load of any trailer is an important weight to measure because it affects the load you can carry in your vehicle. If a trailer is towed, the tongue load must be added to the weight of all occupants riding and any cargo you are carrying in the vehicle. The tongue load typically is ten percent of the trailer weight and everything loaded in it.

Your Mercedes-Benz has been designed primarily to carry passengers and their cargo. Mercedes-Benz does not recommend trailer towing with your vehicle.

Recommended tire inflation pressure

Warning!



Follow recommended tire inflation pressures.

Do not underinflate tires. Underinflated tires wear excessively and /or unevenly, adversely affect handling and fuel economy, and are more likely to fail from being overheated.

Do not overinflate tires. Overinflated tires can adversely affect handling and ride comfort, wear unevenly, increase stopping distance, and result in sudden deflation (blowout) because they are more likely to become punctured or damaged by road debris, potholes etc.

Your vehicle is equipped with either the Tire and Loading Information placard (Example A) or the Vehicle Tire Information placard (Example B) located on the driver's door B-pillar (▷ page 333).

The tire inflation pressure should be checked regularly and should only be adjusted on cold tires. The tires can be considered cold if the vehicle has been parked for at least three hours or driven less than one mile (1.6 km).

Follow recommended cold tire inflation pressures listed on placard.

Keeping the tires properly inflated provides the best handling, tread life and riding comfort.

In addition to the tire placard on the driver's door B-pillar, also consult the fuel filler flap for any additional information pertaining to special driving situations. For more information, see "Important notes on tire inflation pressure" (▷ page 340).



Data shown on placard examples are for illustration purposes only. Tire data is specific to each vehicle and may vary from data shown in the illustrations below. Refer to placard on vehicle for actual data specific to your vehicle.

Placard (Example A)

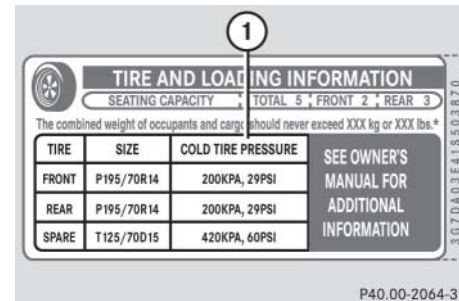

① Tire and Loading Information placard with recommended cold tire inflation pressures

Placard (Example A) lists the recommended cold tire inflation pressures for maximum loaded vehicle weight. The tire inflation pressures listed apply to the tires installed as original equipment.

Tires and wheels

Placard (Example B)

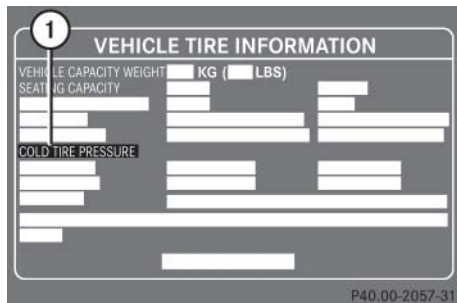

- ① Vehicle Tire Information placard with recommended cold tire inflation pressures

Placard (Example B) lists the recommended cold tire inflation pressures for maximum loaded vehicle weight. The tire inflation pressures listed apply to the tires installed as original equipment.



Placard (Example B) may list recommended cold tire inflation pressures for different vehicle loads.

Important notes on tire inflation pressure

Warning!



If the tire inflation pressure repeatedly drops:

- Check the tires for punctures from foreign objects.
- Check to see whether air is leaking from the valves or from around the rim.

Tire temperature and tire inflation pressure are also increased while driving, depending on the driving speed and the tire load.

If you will be driving your vehicle at high speeds of 100 mph (160 km/h) or higher, where it is legal and conditions allow, consult the placard on the inside of the fuel filler flap on how to adjust the cold tire inflation pressure. If you do not adjust the tire inflation pressure, excessive heat can build up and result in sudden tire failure.

Be sure to readjust the tire inflation pressure for normal driving speeds. You should wait until the tires are cold before adjusting the tire inflation pressure.

Some vehicles may have supplemental tire pressure information for vehicle loads less than the maximum loaded vehicle condition. If such information is provided, it can be found on the placard located on the inside of the fuel filler flap.

Tire inflation pressure changes by approximately 1.5 psi (0.1 bar) per 18°F (10°C) of air temperature change. Keep this in mind when checking tire inflation pressure where the temperature is different from the outside temperature.

Checking tire inflation pressure

Regularly check your tire inflation pressure at least once a month.

Check and adjust the tire inflation pressure when the tires are cold. The tires can be considered cold if the vehicle has been parked for at least three hours or driven less than one mile (1.6 km).

If you check the tire inflation pressure when the tires are warm (the vehicle has been driven for several miles or sitting less than three hours), the reading will be approximately 4 psi (0.3 bar) higher than the cold reading. This is normal. Do not let air out to match the specified cold tire inflation pressure. Otherwise, the tire will be underinflated.

Warning!



Follow recommended tire inflation pressures.

Do not underinflate tires. Underinflated tires wear excessively and / or unevenly, adversely affect handling and fuel economy, and are more likely to fail from being overheated.

Do not overinflate tires. Overinflated tires can adversely affect handling and ride comfort, wear unevenly, increase stopping distance, and result in sudden deflation (blowout) because they are more likely to become punctured or damaged by road debris, potholes etc.

Do not overload the tires by exceeding the specified load limit or vehicle capacity weight as indicated on the placard on the driver's door B-pillar. Overloading the tires can overheat them, possibly causing a blowout.

Checking tire inflation pressure manually

Follow the steps below to achieve correct tire inflation pressure:

- ▶ Remove the cap from the valve on one tire.
- ▶ Firmly press a tire gauge onto the valve.
- ▶ Read tire inflation pressure on tire gauge and check against the recommended tire inflation pressure on the placard on the driver's door B-pillar (▷ page 339). If necessary, add air to achieve the recommended tire inflation pressure.



If you have overfilled the tire, release tire inflation pressure by pushing the metal stem of the valve with e.g. a tip of a pen. Then recheck the tire inflation pressure with the tire gauge.



Tires and wheels

- ▷▷ Install the valve cap.
- ▶ Repeat this procedure for each tire.

Run Flat Indicator*

While the vehicle is being driven, the Run Flat Indicator monitors the set tire inflation pressures by evaluating each wheel's rotational speed. This allows the system to detect a significant loss of pressure in a tire. If a wheel's rotational speed changes due to falling tire inflation pressure, you will see a corresponding warning message in the multifunction display.

The Run Flat Indicator may function in a restricted manner or with a delay if:

- snow chains are mounted to the vehicle
- winter road conditions prevail
- you are driving on a loose surface (e.g. sand or gravel)
- you are driving in a very sporty manner (involving rapid acceleration or high speeds in curves)

Warning!



When the multifunction display shows the message **Low pres. mode Check tire Max. speed 50 mph**, one or more of your tires is significantly under-inflated. You should stop and check your tires as soon as possible, and inflate them to the proper tire inflation pressure as indicated on the vehicle's tire information placard. Driving on a significantly under-inflated tire causes the tire to overheat and can lead to tire failure. Under-inflation also reduces fuel efficiency and tire tread life, and may affect the vehicle's handling and stopping ability. Each tire, including the spare, should be checked monthly when cold and set to the recommended tire inflation pressure as specified in the vehicle placard and owner's manual.



The recommended tire inflation pressures for your vehicle can be found on the tire placard located on the driver's door B-pillar (▷ page 333). The tire inflation pressures are not listed in the owner's manual.

Warning!

The Run Flat Indicator does not indicate a warning for wrongly selected tire inflation pressures. Always adjust tire inflation pressure according to the placard on the driver's door B-pillar or fuel filler flap.

The Run Flat Indicator does not replace regular checks of the tire inflation pressures since a gradual pressure loss in all four tires cannot be detected by the Run Flat Indicator.

The Run Flat Indicator is not able to issue a warning due to a sudden dramatic loss of tire inflation pressure (e.g. tire blowout caused by a foreign object). In this case bring the vehicle to a halt by carefully applying the brakes and avoiding abrupt steering maneuvers.

Reactivating the Run Flat Indicator

The tire inflation pressure monitor must be reactivated in the following situations:

- If you have changed the tire inflation pressure
- If you have replaced the wheels or tires
- If you have installed new wheels or tires
- ▶ Using the tire placard on the driver's door B-pillar or, if available, the inside of the fuel filler flap, make sure the tire inflation pressure of all four tires is correct.



Warning!

The Run Flat Indicator can only warn you in a reliable manner if you have set the correct tire inflation pressures for each tire.

If an incorrect tire inflation pressure was set, the system will monitor the pressure according to the incorrect value.

- ▶ Switch on the ignition (▷ page 34).

Make sure the standard display menu appears in the multifunction display (▷ page 144).

- ▶ Press button  or  repeatedly until the following message appears in the multifunction display:

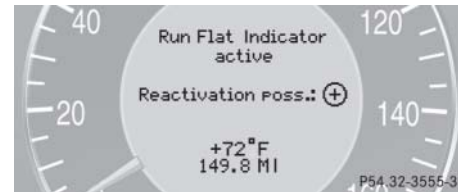

- ▶ Press button .

The following message will appear in the multifunction display:

Tire pres. now
OK?
No Yes

Tires and wheels

If you wish to confirm activation:

- ▶ Press button .

The following message will appear in the multifunction display:

Run Flat Indicator
reactivated

After a certain “learning phase”, the Run Flat Indicator checks the set pressure values for all four tires.

If you wish to cancel activation:

- ▶ Press button .

or

- ▶ Wait until the message

Tire pres. now
OK?
No Yes
disappears.

Potential problems associated with underinflated and overinflated tires

Underinflated tire inflation pressure

Underinflated tires can:

- cause excessive and uneven tire wear
- adversely affect fuel economy
- lead to tire failure from being overheated
- adversely affect handling characteristics

Warning!



Follow recommended tire inflation pressures.

Do not underinflate tires. Underinflated tires wear excessively and / or unevenly, adversely affect handling and fuel economy, and are more likely to fail from being overheated.

Overinflated tire inflation pressure

Overinflated tires can:

- adversely affect handling characteristics
- cause uneven tire wear
- be more prone to damage from road hazards
- adversely affect ride comfort
- increase stopping distance

Warning!



Follow recommended tire inflation pressures.

Do not overinflate tires. Overinflated tires can adversely affect handling and ride comfort, wear unevenly, increase stopping distance, and result in sudden deflation (blowout) because they are more likely to become punctured or damaged by road debris, potholes etc.

MOExtended system*

The *MOExtended* system allows you to continue driving your vehicle even if there is a total loss of pressure in one or more tires.

You may only use the *MOExtended* system in conjunction with the Run Flat Indicator* (▷ page 342).

For information on driving in case of pressure loss in one or more tires (emergency mode), see the “Practical hints” section (▷ page 452).

Tire labeling

Besides tire name (sales designation) and manufacturer name, a number of markings can be found on a tire.

Following are some explanations for the markings on your vehicle’s tires:

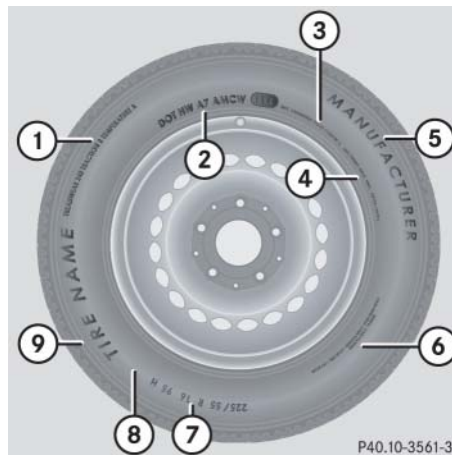

- ① Uniform Quality Grading Standards (▷ page 353)
- ② DOT, Tire Identification Number (TIN) (▷ page 350)
- ③ Maximum tire load (▷ page 351)
- ④ Maximum tire inflation pressure (▷ page 352)
- ⑤ Manufacturer
- ⑥ Tire ply material (▷ page 354)
- ⑦ Tire size designation, load and speed rating (▷ page 346)
- ⑧ Load identification (▷ page 349)
- ⑨ Tire name



For illustration purposes only. Actual data on tires are specific to each vehicle and may vary from data shown in above illustration.

For more information, see “Rims and tires” (▷ page 471).

Tires and wheels

Tire size designation, load and speed rating

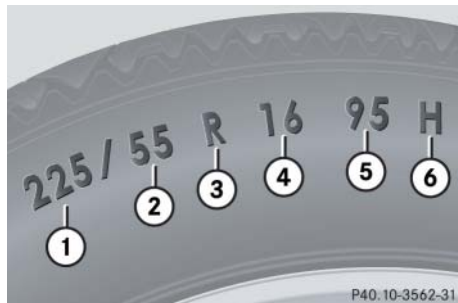

- ① Tire width
- ② Aspect ratio in %
- ③ Radial tire code
- ④ Rim diameter
- ⑤ Tire load rating
- ⑥ Tire speed rating



For illustration purposes only. Actual data on tires are specific to each vehicle and may vary from data shown in above illustration.

General:

Depending on the design standards used, the tire size molded into the sidewall may have no letter or a letter preceding the tire size designation.

No letter preceding the size designation (as illustrated above): Passenger car tire based on European design standards.

Letter “P” preceding the size designation: Passenger car tire based on U.S. design standards.

Letter “LT” preceding the size designation: Light Truck tire based on U.S. design standards.

Letter “T” preceding the size designation: Temporary spare tires which are high pressure compact spares designed for temporary emergency use only.

Tire width

The tire width ① (▷ page 346) indicates the nominal tire width in mm.

Aspect ratio

The aspect ratio ② (▷ page 346) is the dimensional relationship between tire section height and section width and is expressed in percentage. The aspect ratio is arrived at by dividing section height by section width.

Tire code

The tire code ③ (▷ page 346) indicates the tire construction type. The “R” stands for radial tire type. Letter “D” means diagonal or bias ply construction; letter “B” means belted-bias ply construction.

At the tire manufacturer’s option, any tire with a speed capability above 149 mph (240 km/h) can include a “ZR” in the size designation (for example: 245/40 ZR 18). For additional information, see “Tire speed rating” (▷ page 348).

Rim diameter

The rim diameter ④ (▷ page 346) is the diameter of the bead seat, not the diameter of the rim edge. Rim diameter is indicated in inches (in).

Tire load rating

The tire load rating ⑤ (▷ page 346) is a numerical code associated with the maximum load a tire can support.

For example, a load rating of 91 corresponds to a maximum load of 1356 lbs (615 kg) the tire is designed to support. See also “Maximum tire load” (▷ page 351) where the maximum load associated with the load index is indicated in kilograms and lbs.

Warning!

The tire load rating must always be at least half of the GAWR (▷ page 355) of your vehicle. Otherwise, tire failure may be the result which may cause an accident and/or serious personal injury to you or others.

Always replace rims and tires with the same designation, manufacturer and type as shown on the original part.

Warning!

Do not overload the tires by exceeding the specified load limit or vehicle capacity weight as indicated on the placard located on the driver’s door B-pillar. Overloading the tires can overheat them, possibly causing a blowout. Overloading the tires can also result in handling or steering problems, or brake failure.

For additional information on tire load rating, see “Load identification” (▷ page 349).



Tire load rating ⑤ (▷ page 346) and Tire speed rating ⑥ (▷ page 346) are also referred to as “service description”.

Tires and wheels

Tire speed rating

The tire speed rating ⑥ (▷ page 346) indicates the approved maximum speed for the tire.

Warning!



Even when permitted by law, never operate a vehicle at speeds greater than the maximum speed rating of the tires.

Exceeding the maximum speed for which tires are rated can lead to sudden tire failure, causing loss of vehicle control and possibly resulting in an accident and/or personal injury and possible death, for you and for others.



Tire load rating ⑤ (▷ page 346) and Tire speed rating ⑥ (▷ page 346) are also referred to as “service description”.

Summer tires

Index	Speed rating
Q	up to 100 mph (160 km/h)
R	up to 106 mph (170 km/h)
S	up to 112 mph (180 km/h)
T	up to 118 mph (190 km/h)
H	up to 130 mph (210 km/h)
V	up to 149 mph (240 km/h)
W	up to 168 mph (270 km/h)
Y	up to 186 mph (300 km/h)
(Y)	above 186 mph (300 km/h)
ZR	above 149 mph (240 km/h)

- At the tire manufacturer’s option, any tire with a speed capability above 149 mph (240 km/h) can include a “ZR” in the size designation (for example: 245/40 ZR18). To determine the maximum speed capability of the tire, the service description for the tire must be referred to. The service description

is comprised of the tire load rating ⑤ (▷ page 346) and the tire speed rating ⑥ (▷ page 346).

If your tire includes “ZR” in the size designation and no service description ⑤ and ⑥ (▷ page 346) is given, the tire manufacturer must be consulted for the maximum speed capability.

If a service description ⑤ and ⑥ (▷ page 346) is given, the speed capability is limited by the speed symbol in the service description.

Example: 245/40 ZR18 97Y.

In this example, “97Y” is the service description. The letter “Y” designates the speed rating and the speed capability of the tire is limited to 186 mph (300 km/h).

- Any tire with a speed capability above 186 mph (300 km/h) must include a “ZR” in the size designation AND the service description must be placed in parenthesis. Example: 275/40 ZR 18 (99Y). The “(Y)” speed rating in parenthesis designates the maximum speed capability of the tire as being above 186 mph (300 km/h). Consult the tire manufacturer for the actual maximum permissible speed of the tire.

All-season and winter tires

Index	Speed rating
Q M+S ¹	up to 100 mph (160 km/h)
T M+S ¹	up to 118 mph (190 km/h)
H M+S ¹	up to 130 mph (210 km/h)
V M+S ¹	up to 149 mph (240 km/h)

¹ or M+S  for winter tires

i

Not all M+S rated tires provide special winter performance. Make sure the tires you use show M+S and the mountain/snowflake  marking on the tire sidewall. These tires meet specific snow traction performance requirements of the Rubber Manufacturers Association (RMA) and the Rubber Association of Canada (RAC) and have been designed specifically for use in snow conditions.

Load identification



① Load identification

i

For illustration purposes only. Actual data on tires are specific to each vehicle and may vary from data shown in above illustration.

Tires and wheels

In addition to tire load rating, special load information may be molded into the tire sidewall following the letter designating the tire speed rating ① (▷ page 349).

No specification given: absence of any text (like in above example) indicates a standard load (SL) tire.

XL or Extra Load: designates an extra load (or reinforced) tire.

Light Load: designates a light load tire.

C, D, E: designates load range associated with the maximum load a tire can carry at a specified pressure.

DOT, Tire Identification Number (TIN)

U.S. tire regulations require each new tire manufacturer or tire retreader to mold a TIN into or onto a sidewall of each tire produced.

The TIN is a unique identifier which facilitates efforts by tire manufacturers to notify purchasers in recall situations or other safety matters concerning tires and gives purchasers the means to easily identify such tires.

The TIN is comprised of “Manufacturer’s identification mark”, “Tire size”, “Tire type code” and “Date of manufacture”.

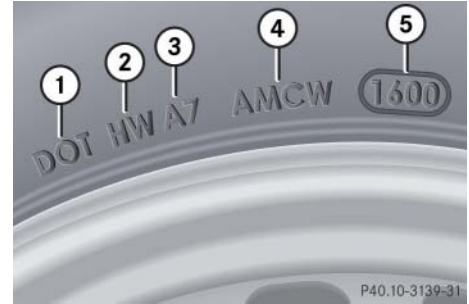

- ① DOT
- ② Manufacturer’s identification mark
- ③ Tire size
- ④ Tire type code (at the option of the tire manufacturer)
- ⑤ Date of manufacture



For illustration purposes only. Actual data on tires are specific to each vehicle and may vary from data shown in above illustration.

DOT (Department of Transportation)

A tire branding symbol ① (▷ page 350) which denotes the tire meets requirements of the U.S. Department of Transportation.

Manufacturer's identification mark

The manufacturer's identification mark ② (▷ page 350) denotes the tire manufacturer.

New tires have a mark with two symbols.

Retreaded tires have a mark with four symbols. For more information on retreaded tires, see (▷ page 330).

Tire size

The code ③ (▷ page 350) indicates the tire size.

Tire type code

The code ④ (▷ page 350) may, at the option of the manufacturer, be used as a descriptive code for identifying significant characteristics of the tire.

Date of manufacture

The date of manufacture ⑤ (▷ page 350) identifies the week and year of manufacture.

The first two figures identify the week, starting with "01" to represent the first full week of the calendar year. The second two figures represent the year.

For example, "3202" represents the 32nd week of 2002.

Maximum tire load

① Maximum tire load rating



For illustration purposes only. Actual data on tires are specific to each vehicle and may vary from data shown in above illustration.

The maximum tire load is the maximum weight the tires are designed to support.

Tires and wheels

Warning!



Do not overload the tires by exceeding the specified load limit or vehicle capacity weight as indicated on the placard located on the driver's door B-pillar. Overloading the tires can overheat them, possibly causing a blowout. Overloading the tires can also result in handling or steering problems, or brake failure.

For more information on tire load rating (▷ page 347).

For information on calculating total and cargo load capacities (▷ page 336).

Maximum tire inflation pressure



- ① Maximum permissible tire inflation pressure



For illustration purposes only. Actual data on tires are specific to each vehicle and may vary from data shown in above illustration.

This is the maximum permissible tire inflation pressure for the tire.

Always follow the recommended tire inflation pressure (▷ page 339) for proper tire inflation.

Warning!



Never exceed the max. tire inflation pressure. Follow recommended tire inflation pressures.

Do not underinflate tires. Underinflated tires wear excessively and / or unevenly, adversely affect handling and fuel economy, and are more likely to fail from being overheated.

Do not overinflate tires. Overinflated tires can adversely affect handling and ride comfort, wear unevenly, increase stopping distance, and result in sudden deflation (blowout) because they are more likely to become punctured or damaged by road debris, potholes etc.

Uniform Tire Quality Grading Standards (U.S. vehicles)

Tire manufacturers are required to grade tires based on three performance factors: treadwear, traction and temperature resistance.

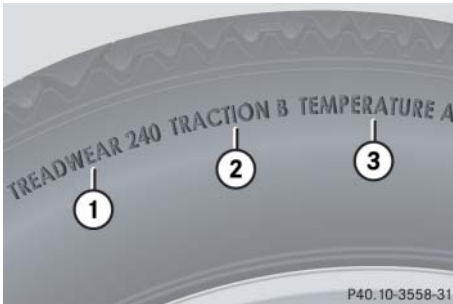

- ① Treadwear
- ② Traction
- ③ Temperature resistance



For illustration purposes only. Actual data on tires are specific to each vehicle and may vary from data shown in above illustration.

Quality grades can be found, where applicable, on the tire sidewall between tread shoulder and maximum section width. For example:

Treadwear	Traction	Temperature
200	AA	A

All passenger car tires must conform to federal safety requirements in addition to these grades.

Treadwear

The treadwear grade is a comparative rating based on the wear rate of the tire when tested under controlled conditions on a specified government test course. For example, a tire graded 150 would wear one and one-half ($1\frac{1}{2}$) times as well on the government course as a tire graded 100. The relative performance of tires depends upon the actual conditions of their use, however, and may depart significantly from the norm due to variations in driving habits, service practices and differences in road characteristics and climate.

Traction

The traction grades, from highest to lowest, are AA, A, B, and C. Those grades represent the tire's ability to stop on wet pavement as measured under controlled conditions on specified government test surfaces of asphalt and concrete. A tire marked C may have poor traction performance.

Tires and wheels

Warning!



The traction grade assigned to this tire is based on straight-ahead braking traction tests, and does not include acceleration, cornering, hydroplaning, or peak traction characteristics.

Temperature

The temperature grades are A (the highest), B, and C, representing the tire's resistance to the generation of heat and its ability to dissipate heat when tested under controlled conditions on a specified indoor laboratory test wheel. Sustained high temperature can cause the material of the tire to degenerate and reduce tire life, and excessive temperature can lead to sudden tire failure. The grade C corresponds to a level of performance which all passenger car tires must meet under the Federal Motor Vehicle Safety Standard No. 109. Grades B and A represent higher levels of performance on the laboratory test wheel than the minimum required by law.

Warning!



The temperature grade for this tire is established for a tire that is properly inflated and not overloaded. Excessive speed, underinflation, or excessive loading, either separately or in combination, can cause excessive heat build-up and possible tire failure.

Tire ply material



- ① Plies in sidewall
- ② Plies under tread



For illustration purposes only. Actual data on tires are specific to each vehicle and may vary from data shown in above illustration.

This marking tells you about the type of cord and number of plies in the sidewall and under the tread.

Tire and loading terminology

Accessory weight

The combined weight (in excess of those standard items which may be replaced) of automatic transmission, power steering, power brakes, power windows, power seats, radio, and heater, to the extent that these items are available as factory-installed equipment (whether installed or not).

Air pressure

The amount of air inside the tire pressing outward on each square inch of the tire. Air pressure is expressed in pounds per square inch (psi), or kilopascal (kPa) or bars.

Aspect ratio

Dimensional relationship between tire section height and section width expressed in percentage.

Bar

Another metric unit for air pressure. There are 14.5038 pounds per square inch (psi) to 1 bar; there are 100 kilopascals (kPa) to 1 bar.

Bead

The tire bead contains steel wires wrapped by steel cords that hold the tire onto the rim.

Cold tire inflation pressure

Tire inflation pressure when your vehicle has been sitting for at least three hours or driven no more than one mile (1.6 km).

Curb weight

The weight of a motor vehicle with standard equipment including the maximum capacity of fuel, oil, and coolant, and, if so equipped, air conditioning and additional optional equipment, but without passengers and cargo.

DOT (Department of Transportation)

A tire branding symbol which denotes the tire meets requirements of the U.S. Department of Transportation.

GAWR (Gross Axle Weight Rating)

The GAWR is the maximum permissible axle weight. The gross vehicle weight on each axle must never exceed the GAWR for the front and rear axle indicated on the certification label located on the driver's door B-pillar.

GVW (Gross Vehicle Weight)

The GVW comprises the weight of the vehicle including fuel, tools, spare wheel, installed accessories, passengers and cargo and, if applicable, trailer tongue load. The GVW must never exceed the GVWR indicated on the certification label located on the driver's door B-pillar.

Tires and wheels

GVWR (Gross Vehicle Weight Rating)

This is the maximum permissible vehicle weight of the fully loaded vehicle (weight of the vehicle including all options, passengers, fuel, and cargo and, if applicable, trailer tongue load). It is indicated on certification label located on the driver's door B-pillar.

Kilopascal (kPa)

The metric unit for air pressure. There are 6.9 kPa to 1 psi; another metric unit for air pressure is bars. There are 100 kilopascals (kPa) to 1 bar.

Maximum load rating

The maximum load in kilograms and pounds that can be carried by the tire.

Maximum loaded vehicle weight

The sum of curb weight, accessory weight, vehicle capacity weight and production options weight.

Maximum tire inflation pressure

This number is the greatest amount of air pressure that should ever be put in the tire under normal driving conditions.

Normal occupant weight

The number of occupants the vehicle is designed to seat, multiplied by 68 kilograms (150 lbs).

Occupant distribution

The distribution of occupants in a vehicle at their designated seating positions.

Production options weight

The combined weight of those installed regular production options weighing over 5 lbs (2.3 kilograms) in excess of those standard items which they replace, not previously considered in curb weight or accessory weight, including heavy duty brakes, ride levelers, roof rack, heavy duty battery, and special trim.

PSI (Pounds per square inch)

A standard unit of measure for air pressure -> bar, kilopascal (kPa).

Recommended tire inflation pressure

Recommended tire inflation pressure listed on placard located on driver's door B-pillar for normal driving conditions. Provides best handling, tread life and riding comfort.

Rim

A metal support for a tire or a tire and tube assembly upon which the tire beads are seated.

Sidewall

The portion of a tire between the tread and the bead.

TIN (Tire Identification Number)

Unique identifier which facilitates efforts by tire manufacturers to notify purchasers in recall situations or other safety matters concerning tires and gives purchases the means to easily identify such tires. The TIN is comprised of “Manufacturer’s identification mark”, “Tire size”, “Tire type code” and “Date of manufacture”.

Tire load rating

Numerical code associated with the maximum load a tire can support.

Tire ply composition and material used

This indicates the number of plies or the number of layers of rubber-coated fabric in the tire tread and sidewall. Tire manufacturers also must indicate the ply materials in the tire and sidewall, which include steel, nylon, polyester, and others.

Tire speed rating

Part of tire designation; indicates the speed range for which a tire is approved.

Traction

Force exerted by the vehicle on the road via the tires. The amount of grip provided.

Tread

The portion of a tire that comes into contact with the road.

Treadwear indicators

Narrow bands, sometimes called “wear bars” that show across the tread of a tire when only $1/16$ in (1.6 mm) of tread remains.

Uniform Tire Quality Grading Standards

A tire information system that provides consumers with ratings for a tire's traction, temperature and treadwear. Ratings are determined by tire manufacturers using government testing procedures. The ratings are molded into the sidewall of the tire.

Vehicle capacity weight

Rated cargo and luggage load plus 68 kilograms (150 lbs) times the vehicle’s designated seating capacity.

Vehicle maximum load on the tire

Load on an individual tire that is determined by distributing to each axle its share of the maximum loaded vehicle weight and dividing it by two.

Tires and wheels

Rotating tires

Warning!



Rotate front and rear wheels only if the tires are of the same dimension.

If your vehicle is equipped with mixed-size tires (different tire dimensions front vs. rear), tire rotation is not possible.

Tire rotation can be performed on vehicles with tires of the same dimension all around. If your vehicle is equipped with tires of the same dimension all around, tires can be rotated, observing a front-to-rear rotation pattern that will maintain the intended rotation (spinning) direction of the tire (▷ page 333).

In some cases, such as when your vehicle is equipped with mixed-size tires (different tire dimension front vs. rear), tire rotation is not possible.

If applicable to your vehicle's tire configuration, tires can be rotated according to the tire manufacturer's recommended intervals in the tire manufacturer's warranty pamphlet located in your vehicle literature portfolio. If none is available, tires should be rotated every 3000 to 6000 miles (5000 to 10000 km), or sooner if necessary, according to the degree of tire wear. The same rotation (spinning) direction must be maintained (▷ page 333).

Rotate tires before the characteristic tire wear pattern becomes visible (shoulder wear on front tires and tread center wear on rear tires).

Thoroughly clean the mounting face of wheels and brake disks, i.e. the inner side of the wheels/tires, during each rotation. Check for and ensure proper tire inflation pressure.

Warning!



Have the tightening torque checked after changing a wheel. Wheels could become loose if not tightened with a torque of 80 lb-ft (110 Nm).

Only use Genuine Mercedes-Benz wheel bolts specified for your vehicle's rims.

For information on wheel change, see the "Practical hints" section (▷ page 413) and (▷ page 446).

▼ Winter driving

Before the onset of winter, have your vehicle winterized at an authorized Mercedes-Benz Center. This service includes:

- Check of anticorrosion and antifreeze concentration.
- Addition of cleaning concentrate to the water of the windshield and headlamp cleaning system. Add MB Concentrate “S” to a premixed windshield washer solvent / antifreeze which is formulated for temperatures below freezing point (▷ page 486).
- Battery test. Battery capacity drops with decreasing ambient temperature. A well charged battery helps to make sure that the engine can be started even at low ambient temperatures.
- Tire change.

Winter tires

Always use winter tires at temperatures below 45°F (7°C) and whenever wintry road conditions prevail. Not all M+S rated tires provide special winter performance. Make sure the tires you use show the mountain/snowflake  marking on the tire sidewall. These tires meet specific snow traction performance requirements of the Rubber Manufacturers Association (RMA) and The Rubber Association of Canada (RAC) and have been designed specifically for use in snow conditions. Use of winter tires is the only way to achieve the maximum effectiveness of the ABS and the ESP® in winter operation.

For safe handling, make sure that all mounted winter tires are of the same make and have the same tread design.

Warning!



Winter tires with a tread depth under $\frac{1}{6}$ in (4 mm) must be replaced. They are no longer suitable for winter operation.

Always observe the speed rating of the winter tires installed on your vehicle. If the maximum speed for which your tires are rated is below the speed rating of your vehicle, you must place a notice to this effect where it will be seen by the driver. Such notices are available at your tire dealer or any authorized Mercedes-Benz Center.

Winter driving

Warning!



If you use your spare tire when winter tires are fitted on the other wheels, be aware that the difference in tire characteristics may very well impair turning stability and that overall driving stability may be reduced. Adapt your driving style accordingly.

Have the spare tire replaced with a winter tire at the nearest authorized Mercedes-Benz Center.

Block heater (Canada only)

The engine is equipped with a block heater.

The electrical cable may be installed at an authorized Mercedes-Benz Center.

Snow chains

Snow chains should only be driven on snow-covered roads at speeds not to exceed 30 mph (50 km/h). Remove chains as soon as possible when driving on roads without snow.



When driving with snow chains, you may wish to deactivate the ESP® (▷ page 90) before setting the vehicle in motion. This will improve the vehicle's traction.

Please observe the following guidelines when using snow chains:

- Using snow chains is not permissible with all wheel/tire combinations.
- Snow chains should only be used on the rear wheels. Follow the manufacturer's mounting instructions.

- Only use snow chains that are approved by Mercedes-Benz. Any authorized Mercedes-Benz Center will be glad to advise you on this subject.
- Use of snow chains may be prohibited depending on location. Always check local and state laws before installing snow chains.



Some tire sizes do not leave adequate clearance for snow chains. To help avoid serious damage to your vehicle or tires, use of snow chains is not permitted with the following tire sizes:

- 245/40 R17 91W
- 245/40 R17 91W MO*Extended*
- T 125/80 R17 99M

▼ Maintenance

We strongly recommend that you have your vehicle serviced by an authorized Mercedes-Benz Center, in accordance with the Maintenance Booklet at the times called for by the maintenance service indicator.

Failure to have the vehicle maintained in accordance with the Maintenance Booklet and maintenance service indicator at the designated times/mileage will result in vehicle damage not covered by the Mercedes-Benz Limited Warranty.

Maintenance service indicator message

The maintenance service indicator message will notify you when your next maintenance service is due.

Starting approximately 1 month before your next maintenance service is due, one of the following messages will appear in the multifunction display while you are driving or when you switch on the ignition (example service A):

Service A in XXXXX miles (km)

Service A in XXX days

Service A due now

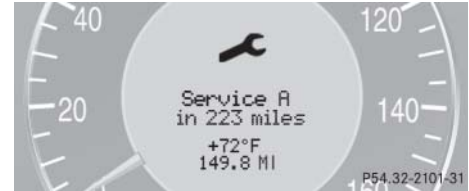

The type of maintenance service due is indicated in the multifunction display:



Basic service (A)



Extended service (B)



Vehicles equipped with FSS (Flexible Service System) only (Canada vehicles): The interval between maintenance services depends on your driving habits. A gentle driving style, moderate engine speeds and the avoidance of short-distance trips will lengthen the interval between services.

Maintenance

Clearing the maintenance service indicator message

The maintenance service indicator message is automatically cleared after approximately 30 seconds when you switch on the ignition or when reaching the maintenance service threshold while driving.

You can also clear it yourself.

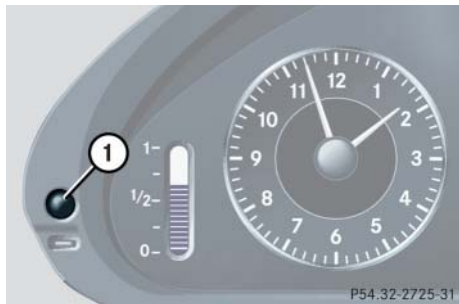

① Reset button

- ▶ Press reset button ① on the instrument cluster.

The maintenance service indicator message is cleared and the standard display appears in the multifunction display (▷ page 144).

Maintenance service term exceeded

If you have exceeded the suggested maintenance service term, you will see the following message in the multifunction display:

Service A exceeded by XXXXX miles (km)







Service A exceeded by XXX days

In addition, a signal sounds when the message appears.

Any authorized Mercedes-Benz Center will reset the maintenance service indicator following a completed maintenance service.

Calling up the maintenance service indicator display

You can call up the maintenance service indicator display at any time to check when the next maintenance service is due.

- ▶ Switch on the ignition (▷ page 36).
- ▶ Press button  or  on the multifunction steering wheel repeatedly until the standard display appears in the multifunction display (▷ page 144).
- ▶ Press button  or  until the maintenance service indicator display with the service symbol  or  and the service deadline appears in the multifunction display.



If the battery is disconnected, the days of disconnection will not be included in the count shown by the maintenance service indicator. To arrive at the true maintenance service deadline, you will need to subtract these days from the days shown in the maintenance service indicator message or maintenance service indicator display.

Do not confuse the maintenance service indicator with the engine oil level indicator .

Resetting the maintenance service indicator

In the event that the maintenance service on your vehicle is not carried out by an authorized Mercedes-Benz Center, you can have the maintenance service indicator reset. The automotive maintenance facility carrying out the maintenance service will find the information for resetting the maintenance service indicator in the maintenance-relevant information for your vehicle. Such information is available from either your authorized Mercedes-Benz Center or directly from Mercedes-Benz.



If the maintenance service indicator was inadvertently reset, have an authorized Mercedes-Benz Center correct it.

Only reset if the proper maintenance service has been performed. Resetting the system without performing the proper service as called for by the maintenance service indicator will result in engine damage and/or other vehicle damage not covered by the Mercedes-Benz Limited Warranty.

Cleaning and care of vehicle

Warning!



Many cleaning products can be hazardous. Some are poisonous, others are flammable. Always follow the instructions on the particular container. Always open your vehicle's doors or windows when cleaning the inside.

Never use fluids or solvents that are not designed for cleaning your vehicle.

Always lock away cleaning products and keep them out of reach of children.

While in operation, even while parked, your vehicle is subject to varying external influences which, if gone unchecked, can attack the paintwork as well as the underbody and cause lasting damage.

Such damage is caused not only by extreme and varying climatic conditions, but also by:

- Air pollution
- Road salt
- Tar
- Gravel and stone chipping

To avoid paint damage, you should immediately remove:

- Grease and oil
- Fuel
- Coolant
- Brake fluid
- Bird droppings
- Insects
- Tree resins, etc.

Frequent washing reduces and /or eliminates the aggressiveness and potency of the above adverse influences.

More frequent washings are necessary to deal with unfavorable conditions:

- near the ocean
- in industrial areas (smoke, exhaust emissions)
- during winter operation

You should check your vehicle from time to time for stone chipping or other damage. Any damage should be repaired as soon as possible to prevent corrosion.

In doing so, do not neglect the underbody of the vehicle. A prerequisite for a thorough check is a washing of the underbody followed by a thorough inspection. Damaged areas need to be re-undercoated.

Your vehicle has been treated at the factory with a wax-base rustproofing in the body cavities which will last for the lifetime of the vehicle. Post-production treatment is neither necessary nor recommended by Mercedes-Benz because of the possibility of incompatibility between materials used in the production process and others applied later.

We have selected car-care products and compiled recommendations which are specially matched to our vehicles and which always reflect the latest technology. You can obtain Mercedes-Benz approved car-care products at an authorized Mercedes-Benz Center.

Scratches, corrosive deposits, corrosion or damage due to negligent or incorrect care cannot always be removed or repaired with the car-care products recommended here. In such cases it is best to seek aid at an authorized Mercedes-Benz Center.

The following topics deal with the cleaning and care of your vehicle and give important “how-to” information as well as references to Mercedes-Benz approved car-care products.

Power washer



Follow the instructions provided by the power washer manufacturer on maintaining a distance between the vehicle and the nozzle of the power washer.

Never use a round nozzle to power-wash tires. The intense jet of water can result in damage to the tire.

Always replace a damaged tire.

Always keep the jet of water moving across the surface. Do not aim directly at electrical parts, electrical connectors, seals, or other rubber parts.



Vehicles with KEYLESS-GO*:
If a door handle is hit by a strong jet of water, and a SmartKey with KEYLESS-GO* is in close proximity, i.e. within approximately 3 ft (approximately 1 m), the vehicle could be inadvertently locked or unlocked.

Tar stains

Quickly remove tar stains before they dry and become more difficult to remove. A tar remover is recommended.

Paintwork, painted body components



Affixing stickers, adhesive tape or similar materials to painted body components may damage the paintwork.

Mercedes-Benz approved Paint Care should be applied when water drops on the paint surface do not “bead up”. This should normally be done every 3 to 5 months, depending on the climate and washing detergent used.

Mercedes-Benz approved Paint Cleaner should be applied if the paint surface shows signs of embedded dirt (i.e. loss of gloss).

Do not apply any of these products or wax if your vehicle is parked in the sun or if the hood is still hot.



Vehicle care

- ▷▷ Use the appropriate MB-Touch-Up Stick for quick and provisional repairs of minor paint damage (i.e. chips from stones, vehicle doors, etc.).

Engine cleaning

Prior to cleaning the engine compartment, make sure to protect electrical components and connectors from contact with water and cleaning agents.

Corrosion protection, such as MB Anticorrosion Wax, should be applied to the engine compartment after every engine cleaning. Before applying, all control linkage bushings and joints should be lubricated. The poly-V-belt and all pulleys should be protected from any wax.

Vehicle washing

In the winter, thoroughly remove all traces of road salt as soon as possible.

When washing the vehicle underbody, do not forget to clean the inner sides of the wheels.



Vehicles with KEYLESS-GO*:
If a door handle is hit by a strong jet of water, and a SmartKey with KEYLESS-GO* is in close proximity, i.e. within approximately 3 ft (approximately 1 m), the vehicle could be inadvertently locked or unlocked.

Hand-wash

Do not use hot water or wash your vehicle in direct sunlight.

- ▶ Only use a mild car wash detergent, such as Mercedes-Benz approved Car Shampoo.
- ▶ Thoroughly spray the vehicle with a diffused jet of water.
Direct only a very weak spray towards the ventilation intake.
- ▶ Use plenty of water and rinse the sponge and chamois frequently.
- ▶ Rinse with clean water and thoroughly dry with a chamois.
Do not allow cleaning agents to dry on the finish.

Automatic car wash

You can have your car washed in an automatic car wash from the start. Automatic car washes without brushes are preferable.

If the vehicle is very dirty, prewash it before running it through the automatic car wash.



Due to the width of the vehicle, fold in exterior rear view mirrors prior to running the vehicle through an automatic car wash to prevent damage to the mirrors.

Make sure that the combination switch is set to **0** (▷ page 53). Otherwise, the rain sensor could activate and cause the wipers to move unintentionally. This may lead to vehicle damage.



After running the vehicle through an automatic car wash, wipe any wax off of the windshield (▷ page 370). This will prevent smears and reduce wiping noise which can be caused by residual wax on the windshield.

When leaving the car wash, make sure that the mirrors are folded out. Otherwise they may vibrate.

Soft top

Clean soft top with soft top raised and locked. Lower the soft top into the storage compartment only if the soft top is completely dry. If the soft top is kept in the storage compartment for a lengthy period, raise it and air out with the windows open about every 4 months.

Light colored soft tops should be cleaned frequently to prevent spots and dirt from setting in, which could stain and discolor the soft top material permanently.



Remove bird droppings immediately. The organic acid damages the material and causes the soft top to leak.

Never use a power washer to clean the soft top, as you may damage the soft top material.

Do not use sharp-edged instruments for the removal of ice and snow.

Never use hot-wax when you run the vehicle through an automatic car wash, as you may damage the soft top material.



Depending on the operation mode of the car wash, there is the possibility of water drops entering the vehicle's interior. This is not an indication of a defect or malfunction in the soft top.

Vehicle care

Dry cleaning:

- ▶ Brush the dry top with a soft-bristled brush.

Brush top always from front to rear.

Wet cleaning:

- ▶ Brush the top with a soft-bristled brush.

Wash with clear water or with a mild detergent and an ample supply of luke-warm water by wiping with a soft-bristled brush or sponge from front to rear. Then rinse thoroughly with clear water.

Wash the top only when heavily soiled.

If only parts of the top have been washed, wet the entire top and allow it to air-dry before lowering it into the storage compartment.



In general, regular spraying or cleaning with clear water is sufficient to keep the soft top clean.

For cleaning soft top or wind screen never use:

- gasoline
- thinner
- tar and stain removers
- glass cleaner
- similar organic solvents

They will cause damage which is not covered by the Mercedes-Benz Limited Warranty.

Ornamental moldings

For regular cleaning and care of ornamental moldings, use a damp cloth.



Do not use chrome cleaner on ornamental moldings. Although ornamental moldings may have chrome appearance, they could be made of anodized aluminum that will be damaged when cleaned with chrome cleaner. Instead, use a damp cloth to clean those ornamental moldings.

For very dirty ornamental moldings of which you are sure are chrome-plated, use a chrome cleaner. If in doubt whether an ornamental molding is chrome-plated, contact an authorized Mercedes-Benz Center.

Headlamps, tail lamps, side markers, turn signal lenses

- ▶ Use a mild car wash detergent, such as Mercedes-Benz approved Car Shampoo, with plenty of water.



Only use window cleaning solutions that are suitable for plastic lamp lenses. Window cleaning solutions which are not suitable may damage the plastic lamp lenses of the headlamps. Therefore, do not use abrasives, solvents or cleaners that contain solvents.

Never apply strong force and only use a soft, non-scratching cloth when cleaning the lenses. Do not attempt to wipe dirty lenses with a dry cloth or sponge.

Otherwise you may scratch or damage the lens surface.

Cleaning the Parktronic system* (Canada only) sensors

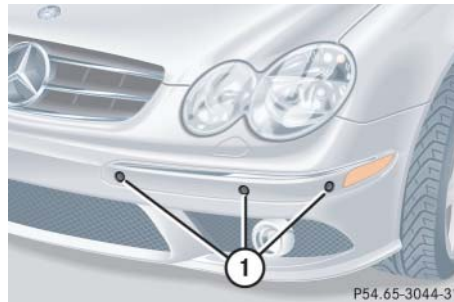

- ① Parktronic system* sensors in front bumper
- ▶ Use a mild car wash detergent, such as Mercedes-Benz approved Car Shampoo, with plenty of water and a soft, non-scratching cloth to clean sensors ① on the bumpers.



Do not apply strong pressure to the sensor covers. Applying strong pressure may damage the sensor covers.

Follow the instructions provided by the power washer manufacturer on maintaining a distance between the vehicle and the nozzle of the power washer.



To prevent scratches, never apply strong force and only use a soft, non-scratching cloth when cleaning the sensors. Do not attempt to wipe dirty sensors with a dry cloth or sponge.

Vehicle care

Cleaning the windows and the wiper blades

Warning!



For safety reasons, switch off wipers and remove SmartKey from starter switch (vehicles with KEYLESS-GO*: Make sure the vehicle's on-board electronics have status **0**) before cleaning the windshield and/or the wiper blades. Otherwise, the wiper motor could suddenly turn on and cause injury.

- ▶ Fold the wiper arms forward until they snap into place.
- ▶ Clean the wiper blade inserts with a clean cloth and detergent solution.
- ▶ Use a soft, clean cloth and a mild window cleaning solution on all outside and inside glass surfaces.

An automotive glass cleaner is recommended.



Fold the windshield wiper arms back onto the windshield before turning the SmartKey in the starter switch or pressing the KEYLESS-GO start/stop button (vehicles with KEYLESS-GO*).

Hold on to the wiper when folding the wiper arm back. If released, the force of the impact from the tensioning spring could crack the windshield.



To clean the window interior, do not use a dry cloth, abrasives, solvents or cleaners containing solvents. Do not touch the inside of the front, rear or side windows with hard objects such as an ice scraper or ring. Doing so may damage the windows.

Light alloy wheels

If possible, clean wheels once a week.

- ▶ Use Mercedes-Benz approved Wheel Care, a soft bristle brush and a strong spray of water for cleaning the light alloy wheels.



Only use acid-free cleaning materials. Acid may cause corrosion or damage the clear coat.



The vehicle should not be parked for an extended period of time immediately after it has been cleaned, especially not after the wheel rims have been cleaned with wheel rim cleaner. Wheel rim cleaners can lead to increased corrosion of the brake disks and brake pads. Therefore, the vehicle's brake system should always be warmed-up before it is parked after cleaning. To do so, please drive your vehicle for several minutes to allow the brakes to dry.

When applying Mercedes-Benz approved Tire Care and Mercedes-Benz approved Wheel Care products, take care not to spray them on the brake disks.

Plastic and rubber parts

- ▶ Use a gentle dishwashing detergent or mild detergent for delicate fabrics as a washing solution.



Do not use oil or wax on these parts.

Instrument cluster and cup holders

- ▶ Use a gentle dishwashing detergent or mild detergent for delicate fabrics as a washing solution.
- ▶ Wipe with a cloth moistened in a lukewarm solution.



To prevent scratches, do not use scouring agents.

Hard plastic trim items

- ▶ Use Mercedes-Benz approved Interior Care, a soft, lint-free cloth and apply with light pressure.



To prevent scratches, do not use scouring agents.

Steering wheel and gear selector lever

- ▶ Wipe with a damp cloth and dry thoroughly or clean with Mercedes-Benz approved Leather Care.

Carpets

- ▶ Use Mercedes-Benz approved Carpet and Fabric Care for cleaning the carpets.

Headliner and shelf below rear window

- ▶ Use a soft bristle brush or a dry-shampoo cleaner in case of excessive dirt.

Seat belts

- ▶ Only use clear, lukewarm water and soap.



The webbing must not be treated with chemical cleaning agents. Do not dry the webbing at temperatures above 176°F (80°C) or in direct sunlight.

Warning!



Do not bleach or dye seat belts as this may severely weaken them. In a crash they may not be able to provide adequate protection.

Vehicle care

Upholstery

Using aftermarket seat covers or wearing clothing that have the tendency to give off coloring (e.g. when wet, etc.) may cause the upholstery to become permanently discolored. By lining the seats with a proper intermediate cover, contact-discoloration will be prevented.

Leather upholstery

- ▶ Wipe leather upholstery with a damp cloth and dry thoroughly or clean with Mercedes-Benz approved Leather Care.

Exercise particular care when cleaning perforated leather as its underside should not become wet.

Nubuck leather upholstery (only for CLK 55 AMG)

The nubuck leather upholstery is treated with a protective coating.

- ▶ Wipe nubuck leather upholstery with damp microfiber cloth to remove dust and other light stains.
- ▶ Carefully dab nubuck leather upholstery with a dry microfiber cloth to remove oil stains.



Do not use Mercedes-Benz approved Leather Care or any solvents to clean nubuck leather upholstery.

Avoid hard scrubbing on nubuck leather upholstery.

Wood trims

- ▶ Dampen cloth using water and use damp cloth to clean wood trims in your vehicle.



Do not use solvents like tar remover or wheel cleaner nor polishes or waxes as these may be abrasive.

Practical hints

What to do if ...?

Where will I find...?

Unlocking/locking in an emergency

Opening/closing in an emergency

Resetting activated head restraints

Replacing SmartKey batteries

Replacing bulbs

Replacing wiper blades

Flat tire

Battery

Jump starting

Towing the vehicle

Fuses



What to do if ...?

Lamps in instrument cluster

General information:

If any of the following bulbs in the instrument cluster fails to come on during the

bulb self-check when switching on the ignition, have the respective bulb checked and replaced if necessary.

Problem	Possible cause/consequence	Suggested solution
 The yellow ABS indicator lamp comes on while driving.	<p>The ABS has detected a malfunction and has switched off. The BAS and the ESP® are also switched off (see messages in display).</p> <p>The brake system is still functioning normally but without the ABS available.</p> <p>If the ABS control unit is malfunctioning, other systems such as the navigation system* or the automatic transmission may also be malfunctioning.</p>	<ul style="list-style-type: none"> ▶ Continue driving with added caution. Wheels will lock during hard braking, reducing steering capability. ▶ Read and observe messages in the multifunction display (▷ page 383). ▶ Have the system checked at an authorized Mercedes-Benz Center as soon as possible. <p>Failure to follow these instructions increases the risk of an accident.</p>
	<p>The charging voltage has fallen below 10 volts and the ABS has switched off.</p> <p>The battery might not be charged sufficiently.</p>	<ul style="list-style-type: none"> ▶ Switch off electrical consumers that are currently not needed, e.g. seat heating*. ▶ If necessary, have the generator (alternator) and battery checked. <p>When the voltage is above this value again, the ABS is operational again.</p>

Problem		Possible cause/consequence	Suggested solution
BRAKE 	(USA only)	The red brake warning lamp comes on while driving and you hear a warning sound.	▶ Release the parking brake (▷ page 50).
	(Canada only)	The red brake warning lamp comes on while driving.	
		There is insufficient brake fluid in the reservoir.	▶ Risk of accident! Carefully stop the vehicle and notify an authorized Mercedes-Benz Center. Do not add brake fluid! This will not solve the problem.

Warning!





Driving with the brake warning lamp illuminated can result in an accident. Have your brake system checked immediately if the brake warning lamp stays on. Do not add brake fluid before checking the brake system.



Overfilling the brake fluid reservoir can result in spilling brake fluid on hot engine parts and the brake fluid catching fire. You can be seriously burned.



If you find that the brake fluid in the brake fluid reservoir has fallen to the minimum mark or below, have the brake system checked for brake pad thickness and leaks.

What to do if ...?

Problem		Possible cause/consequence	Suggested solution
 (USA only)  (Canada only)	The yellow engine malfunction indicator lamp comes on while driving.	There is a malfunction in: <ul style="list-style-type: none"> • The fuel management system • The ignition system • The emission control system • Systems which affect emissions Such malfunctions may result in excessive emissions values and may switch the engine to its Limp-Home Mode (emergency operation).	<ul style="list-style-type: none"> ▶ Have the vehicle checked as soon as possible by an authorized Mercedes-Benz Center. An on-board diagnostic connector is used by the service station to link the vehicle to the shop diagnostics system. It allows the accurate identification of system malfunctions through the readout of diagnostic trouble codes. It is located in the front left area of the footwell next to the parking brake pedal.
		A loss of pressure has been detected in the fuel system. The fuel cap may not be closed properly or the fuel system may be leaky.	<ul style="list-style-type: none"> ▶ Check the fuel cap (▷ page 318). If it is not closed properly: <ul style="list-style-type: none"> ▶ Close the fuel cap. If it is closed properly: <ul style="list-style-type: none"> ▶ Have the fuel system checked by an authorized Mercedes-Benz Center.
		Your fuel tank is empty.	<ul style="list-style-type: none"> ▶ After refuelling, start turn off and restart the engine three or four times in succession. The Limp-Home mode is canceled. You do not need to have your vehicle checked.

Problem	Possible cause/consequence	Suggested solution
 <p>The red coolant warning lamp comes on when the engine is running.</p>	There is insufficient coolant in the reservoir.	▶ Add coolant to prevent engine from overheating (▷ page 327).
	If this warning lamp comes on frequently, there is a leak in the cooling system.	▶ Have the cooling system checked.
	If the coolant level is correct, the electric radiator fan may be broken.	▶ If the coolant temperature is below 257 °F (125 °C), you can continue driving to the nearest authorized Mercedes-Benz Center. ▶ Avoid high engine loads (e.g. driving uphill) and stop-and-go driving.
 <p>The red coolant warning lamp comes on while driving and you hear a warning sound.</p>	The coolant temperature has exceeded 257 °F (125 °C).	▶ Stop as soon as possible and allow the engine and coolant to cool down.

Warning!









Driving when your engine is badly overheated can cause some fluids which may have leaked into the engine compartment to catch fire. You could be seriously burned.

Steam from an overheated engine can cause serious burns and can occur just by opening the hood. Stay away from the engine if you see or hear steam coming from it.

Turn off the engine, get out of the vehicle and do not stand near the vehicle until the engine has cooled down.

What to do if ...?

Problem	Possible cause/consequence	Suggested solution
 The yellow ESP® warning lamp comes on while driving.	The ESP® is deactivated. Risk of accident! Adapt your speed and driving to the prevailing road conditions.	<ul style="list-style-type: none"> ▶ Switch the ESP® back on (▷ page 91). If the ESP® cannot be switched back on, have the system checked at an authorized Mercedes-Benz Center as soon as possible.
 The yellow ESP® warning lamp flashes while driving.	The ESP® or traction control has come into operation because of detected traction loss in at least one tire.	<ul style="list-style-type: none"> ▶ When driving off, apply as little throttle as possible. ▶ While driving, ease up on the accelerator. ▶ Adapt your speed and driving to the prevailing road and weather conditions. ▶ Do not deactivate the ESP®. Exceptions: (▷ page 90). Failure to follow these instructions increases the risk of accidents.

Problem	Possible cause/consequence	Suggested solution
 The yellow fuel tank reserve warning lamp comes on while driving.	The fuel level has gone below the reserve mark.	<ul style="list-style-type: none"> ▶ Refuel at the next gas station (▷ page 318).
 The yellow roll bar warning lamp comes on or flickers when the engine is running.	The roll bar system is malfunctioning.	<ul style="list-style-type: none"> ▶ Release the roll bars manually. ▶ Have the system checked at an authorized Mercedes-Benz Center as soon as possible.
 The red seat belt telltale comes on after starting the engine with all doors closed.	The seat belt telltale reminds you and your passengers to fasten your seat belts before driving off.	<ul style="list-style-type: none"> ▶ Fasten your seat belts.
 The red seat belt telltale flashes and you additionally hear an intermittent warning signal with increasing intensity for a maximum of 60 seconds when the vehicle's speed exceeds 15 mph (25 km/h).	<p>You and/or your front passenger have forgotten to fasten your seat belts.</p> <p>There are items placed on the front passenger seat and therefore the system senses the front passenger seat as being occupied.</p>	<ul style="list-style-type: none"> ▶ Fasten your seat belts. ▶ Remove the items from the front passenger seat and put them in a safe place.

What to do if ...?

Problem	Possible cause/consequence	Suggested solution
SRS The red SRS indicator lamp comes on while driving.	There is a malfunction in the restraint systems. The air bags or emergency tensioning devices (ETDs) could deploy unexpectedly or fail to deploy in an accident.	► Drive with added caution to the nearest authorized Mercedes-Benz Center.

Warning!



In the event a malfunction of the SRS is indicated as outlined above, the SRS may not be operational. For your safety, we strongly recommend that you visit an authorized Mercedes-Benz Center immediately to have the system checked; otherwise the SRS may not be deployed when needed in an accident, which could result in serious or fatal injury, or it might deploy unexpectedly and unnecessarily which could also result in an accident and/or injury to you or to others.

Lamp in center console

Problem	Possible cause/consequence	Suggested solution
 <p>The front passenger front air bag off indicator lamp illuminates and remains illuminated with the weight of a typical adult or someone larger than a small individual on the front passenger seat.</p>	<p>The system is malfunctioning.</p>	<ul style="list-style-type: none"> ▶ Have the system checked as soon as possible by an authorized Mercedes-Benz Center. ▶ Read and observe messages in the multifunction display and follow corrective steps (▷ page 389).

Warning!



If the  indicator lamp illuminates and remains illuminated with the weight of a typical adult or someone larger than a small individual on the front passenger seat, do not have any passenger use the front passenger seat until the system has been repaired.

What to do if ...?

Problem	Possible cause/consequence	Suggested solution
 <p>The front passenger front air bag off indicator lamp does not illuminate and/or does not remain illuminated with the weight of a typical 12-month-old child in a standard child restraint or less on the front passenger seat.</p>	<p>The system is malfunctioning.</p>	<ul style="list-style-type: none"> ▶ Make sure that there is nothing between seat cushion and child seat and check installation of the child seat. ▶ Make sure that no objects applying supplemental weight onto the seat are present. ▶ If the front passenger front air bag off indicator lamp remains out, have the system checked as soon as possible by an authorized Mercedes-Benz Center. Do not transport a child on the front passenger seat until the system has been repaired. ▶ Read and observe messages in the multifunction display and follow corrective steps (▷ page 389).

Warning!



If the  indicator lamp does not illuminate or remains out with the

weight of a typical 12-month-old child in a standard child restraint or less on the front passenger seat, do not transport a child on the front passenger seat until the system has been repaired.

Vehicle status messages in the multifunction display





Warning and malfunction messages appear in the multifunction display located in the instrument cluster.





Certain warning and malfunction messages are accompanied by an audible signal.

Address these messages accordingly and follow the additional instructions given in this Operator's Manual.

Selecting the vehicle status message memory menu in the control system (▷ page 146) displays both cleared and uncleared messages.

High-priority messages appear in the multifunction display in red color.

Certain messages of high priority cannot be cleared from the multifunction display using the reset button (▷ page 136) or button , , , or  on the steering wheel.

Other messages of high priority and messages of less immediate priority can be cleared from the multifunction display using the reset button (▷ page 136) or button , , , or  on the steering wheel. They are then stored in the vehicle status message memory (▷ page 146). Remember that clearing a message will only make the message disappear. Clearing a message will not correct the condition that caused the message to appear.

Warning!



All categories of messages contain important information which should be taken note of and, where a malfunction is indicated, addressed as soon as possible at an authorized Mercedes-Benz Center.

Failure to repair condition noted may cause damage not covered by the Mercedes-Benz Limited Warranty, or result in property damage or personal injury.

Warning!



No messages will be displayed if either the instrument cluster or the multifunction display is inoperative.

Contact your nearest authorized Mercedes-Benz Center.

What to do if ...?



Switching on the ignition causes all instrument cluster lamps (except low beam headlamp indicator lamp, high beam headlamp indicator lamp, and turn signal indicator lamps unless activated) as well as the multifunction display to come on. Make sure the lamps and the multifunction display are in working order before starting your journey.

On the pages that follow, you will find a compilation of the most important warning and malfunction messages that may appear in the display.

For your convenience the messages are divided into two sections:

- Text messages (▷ page 385)
- Symbol messages (▷ page 395)

Text messages

Display message	Possible cause/consequence	Possible solution
<p>ABS</p> <p>malfunction Visit workshop</p>	<p>The ABS has detected a malfunction and has switched off. The ESP® and the BAS are also deactivated.</p> <p>The brake system is still functioning normally but without the ABS available.</p>	<ul style="list-style-type: none"> ▶ Continue driving with added caution. Wheels will lock during hard braking, reducing steering capability. ▶ Have the system checked at an authorized Mercedes-Benz Center as soon as possible. <p>Failure to follow these instructions increases the risk of an accident.</p>
<p>Display malfunction Visit workshop</p>	<p>The ABS or the ABS display is malfunctioning.</p>	<ul style="list-style-type: none"> ▶ Continue driving with added caution. Wheels will lock during hard braking, reducing steering capability. ▶ Have the system checked at an authorized Mercedes-Benz Center as soon as possible. <p>Failure to follow these instructions increases the risk of an accident.</p>

What to do if ...?

Display message	Possible cause/consequence	Possible solution
ABS Anti-lock braking system inoperative	<p>The charging voltage has fallen below 10 volts and the ABS has switched off.</p> <p>The brake system is still functioning normally but without the ABS available.</p>	<ul style="list-style-type: none">▶ When the voltage is above this value again, the ABS is operational again.▶ Continue driving with added caution. Wheels will lock during hard braking, reducing steering capability.▶ Have the system checked at an authorized Mercedes-Benz Center as soon as possible. <p>Failure to follow these instructions increases the risk of an accident.</p>



Display message	Possible cause/consequence	Possible solution
<p>ESP unavailable See Operator's Manual</p>	<p>The ESP® was deactivated because of a malfunction or interrupted power supply. The BAS and the Run Flat Indicator* are also deactivated.</p> <p>The ABS might not be operational.</p> <p>The brake system is still functioning normally but without the systems specified above.</p> <p>If the yellow ESP® warning lamp  flashes while driving and this message appears, the electronic traction system has switched off to prevent overheating of the drive wheel brakes.</p> <p>The self-diagnosis has not been completed yet.</p> <p>The ESP®, BAS and the Run Flat Indicator* are temporarily deactivated.</p> <p>The brake system is still functioning normally but without the systems specified above.</p>	<ul style="list-style-type: none"> ▶ Continue driving with added caution. ▶ Visit an authorized Mercedes-Benz Center as soon as possible. <p>Failure to follow these instructions increases the risk of an accident.</p> <p>As soon as the brakes have cooled off, the electronic traction system switches on again.</p> <p>The display will clear after driving a short distance at more than 12 mph (20 km/h).</p>

What to do if ...?

Display message	Possible cause/consequence	Possible solution
ESP unavailable See Operator's Manual	<p>The charging voltage has fallen below 10 volts. The battery might not be charged sufficiently.</p> <p>The ESP®, BAS and the Run Flat Indicator* are deactivated.</p> <p>The brake system is still functioning normally but without the systems specified above.</p>	<ul style="list-style-type: none"> ▶ Continue driving with added caution. ▶ If necessary, have the generator and battery checked. <p>When the voltage is above this value again, the ESP® is operational again.</p>
malfunction Visit workshop	<p>The ESP® is deactivated because of a malfunction.</p> <p>The ESP®, BAS and the Run Flat Indicator* are deactivated.</p> <p>The brake system is still functioning normally but without the systems specified above.</p>	<ul style="list-style-type: none"> ▶ Continue driving with added caution. ▶ Visit an authorized Mercedes-Benz Center as soon as possible. <p>Failure to follow these instructions increases the risk of an accident.</p>
Display malfunction Visit workshop	<p>The ESP® or the ESP® display is malfunctioning.</p>	<ul style="list-style-type: none"> ▶ Continue driving with added caution. ▶ Visit an authorized Mercedes-Benz Center as soon as possible. <p>Failure to follow these instructions increases the risk of an accident.</p>

Display message	Possible cause/consequence	Possible solution
<p>Front passenger air bag activated see Oper.'s Man.</p>	<p>Front passenger front air bag is activated while driving even though a child, small individual, or object below the system's weight threshold is on the front passenger seat, or the front passenger seat is empty. Objects on the seat or forces acting on the seat may make the system sense supplemental weight.</p>	<p>Stop the vehicle in a safe location as soon as possible and check the front passenger seat for the following:</p> <ul style="list-style-type: none"> ▶ Switch off the ignition (▷ page 34). ▶ Remove child and child restraint from front passenger seat and properly secure the child in rear seat employing the child restraint if necessary. ▶ Make sure that no objects applying supplemental weight onto the seat are present. The system may recognize such supplemental weight and sense that an occupant on the front passenger seat is of a greater weight than actually present. ▶ Keep the seat unoccupied, close the front passenger door and switch on the ignition (▷ page 34). <p>(Continued on next page)</p>

What to do if ...?

Display message	Possible cause/ consequence	Possible solution
Front passenger air bag activated see Oper.'s Man.		<p>Monitor the  indicator lamp on the center console (▷ page 27) and the multifunction display in the instrument cluster (▷ page 24) for the following:</p> <p>With the seat unoccupied and the ignition turned on,</p> <ul style="list-style-type: none"> the  indicator lamp on the center console should illuminate and remain illuminated, indicating that the OCS (▷ page 78) has deactivated the air bag. the message Front passenger air bag activated see Oper.'s Man. or the message Front passenger air bag deactivated see Oper.'s Man. should not appear in the multifunction display at any time the seat is unoccupied. Wait at last 60 seconds for the system to complete the necessary check cycles and to make sure neither message appears in the multifunction display. <p>If above conditions are met, you can occupy the front passenger seat again. Depending on the front passenger classification sensed by the OCS (▷ page 78), the  indicator lamp will remain illuminated or go out.</p> <p>If above conditions are not met, the system is not working properly. Have the system checked as soon as possible by an authorized Mercedes-Benz Center.</p>

Warning!









If the  indicator lamp remains

on even after performing the above corrective steps, do not have any children 12 years old and under and other small individuals

use the front passenger seat until the system has been repaired.



Display message	Possible cause/consequence	Possible solution
Front passenger air bag deactivated see Oper.'s Man.	Front passenger front air bag is deactivated while driving even though an adult or someone larger than a small individual is occupying the front passenger seat. Forces acting on the seat may make the system sense a decrease in weight.	Stop the vehicle in a safe location as soon as possible and check the front passenger seat for the following: <ul style="list-style-type: none">▶ Switch off the ignition (▷ page 34).▶ Have the front passenger vacate the seat and exit the vehicle.▶ Keep the seat unoccupied, close the front passenger door and switch on the ignition (▷ page 34). (Continued on next page)

What to do if ...?

Display message	Possible cause/ consequence	Possible solution
Front passenger air bag deactivated see Oper.'s Man.		<p>Monitor the   indicator lamp on the center console (▷ page 27) and the multifunction display in the instrument cluster (▷ page 24) for the following:</p> <p>With the seat unoccupied and the ignition turned on,</p> <ul style="list-style-type: none"> the   indicator lamp on the center console should illuminate and remain illuminated, indicating that the OCS (▷ page 78) has deactivated the air bag. the message Front passenger air bag activated see Oper.'s Man. or the message Front passenger air bag deactivated see Oper.'s Man. should not appear in the multifunction display at any time the seat is unoccupied. Wait at last 60 seconds for the system to complete the necessary check cycles and to make sure neither message appears in the multifunction display. <p>If above conditions are met, you can occupy the front passenger seat again. Depending on the front passenger classification sensed by the OCS (▷ page 78), the   indicator lamp will remain illuminated or go out.</p> <p>If above conditions are not met, the system is not working properly. Have the system checked as soon as possible by an authorized Mercedes-Benz Center.</p>

Warning!



If the   indicator lamp remains

illuminated with an adult occupant on the front passenger seat even after performing the above corrective steps, do not have any

passenger use the front passenger seat until the system has been repaired.

Display message	Possible cause/consequence	Possible solution
<p>P</p> <p>Selector lever in park position</p>	<p>You have turned off the engine with the KEYLESS-GO* start/stop button in gear selector lever position N and opened the driver's door.</p> <p>or</p> <p>You have attempted to switch off the engine with the KEYLESS-GO* start/stop button while the gear selector lever was in position R or D.</p>	<p>► Place the gear selector lever in position P.</p>
<p>Please shift to N or P</p>	<p>You have attempted to start the engine with the KEYLESS-GO* start/stop button while the gear selector lever was in position R or D.</p>	<p>► Place the gear selector lever in position P or N.</p>

What to do if ...?

Display message	Possible cause/consequence	Possible solution
Run Flat Indicator inactive	Run Flat Indicator* is malfunctioning.	▶ Have the Run Flat Indicator* checked by an authorized Mercedes-Benz Center.
Check tires Then reactivate Run Flat Indicator	There was a warning message about a loss in the tire inflation pressure and the Run Flat Indicator* has not been reactivated yet.	▶ Make sure that the correct tire inflation pressure is set for each tire. ▶ Then reactivate the Run Flat Indicator*.
Run Flat Indicator unavailable	The Run Flat Indicator* has been switched off due to an error.	▶ Have the Run Flat Indicator* checked by an authorized Mercedes-Benz Center.

Warning!







Do not drive with a flat tire. A flat tire affects the ability to steer or brake the vehicle. You may lose control of the vehicle. Continued driving with a flat tire will cause excessive heat build-up and possibly a fire.

Symbol messages

Display symbol	Display message	Possible cause/consequence	Possible solution
	Visit workshop	The battery is no longer charging. Possible causes: <ul style="list-style-type: none"> • broken poly-V-belt • alternator malfunctioning 	<ul style="list-style-type: none"> ▶ Stop immediately in a safe location or as soon as it is safe to do so and check the poly-V-belt. If it is broken: <ul style="list-style-type: none"> ▶ Do not continue to drive. Otherwise the engine will overheat due to an inoperative water pump which may result in damage to the engine. Notify an authorized Mercedes-Benz Center. If it is intact: <ul style="list-style-type: none"> ▶ Drive immediately to the nearest authorized Mercedes-Benz Center.
	Low voltage Charge battery	The battery has insufficient voltage.	▶ Start the engine (▷ page 48).
	Low voltage Switch off consumers	The battery has insufficient voltage.	▶ Turn off unnecessary electrical consumers.

What to do if ...?

Display symbol	Display message	Possible cause/consequence	Possible solution
	Brake wear Visit workshop	The brake pads have reached their wear limit.	▶ Have the brake pads replaced as soon as possible.
 (USA only)  (Canada only)	Release parking brake	You are driving with the parking brake set.	▶ Release the parking brake (▷ page 50).
	Brake fluid Visit workshop	There is insufficient brake fluid in the reservoir.	▶ Risk of accident! Stop the vehicle in a safe location as soon as possible and notify an authorized Mercedes-Benz Center. Do not add brake fluid! This will not solve the problem.

Warning!





Driving with the message “Brake fluid Visit workshop” displayed can result in an accident. Have your brake system checked immediately. Do not add brake fluid before checking the brake system. Overfilling the brake fluid reservoir can result in spilling brake fluid on hot engine parts and the brake fluid catching fire. You can be seriously burned.



If you find that the brake fluid in the brake fluid reservoir has fallen to the minimum mark or below, have the brake system checked for brake pad thickness and leaks.



Brake pad thickness must be visually checked by a qualified technician at the intervals specified in the Maintenance Booklet.

Display symbol	Display message	Possible cause/consequence	Possible solution
	Visit workshop	There may be a malfunction in the <ul style="list-style-type: none"> • fuel injection system • ignition system • exhaust system • fuel system 	▶ Have the measuring system checked by an authorized Mercedes-Benz Center.
	Coolant Check level	The coolant level is too low.	▶ Add coolant (▷ page 327). ▶ If you have to add coolant frequently, have the cooling system checked by an authorized Mercedes-Benz Center.

Warning!



Do not spill antifreeze on hot engine parts. Antifreeze contains ethylene glycol which may burn if it comes into contact with hot engine parts. You can be seriously burned.



Do not ignore the low engine coolant level warning. Extended driving with the message and symbol displayed may cause serious engine damage not covered by the Mercedes-Benz Limited Warranty.

Do not drive without sufficient amount of coolant in the cooling system. The engine will overheat, causing major engine damage.

What to do if ...?

Display symbol	Display message	Possible cause/consequence	Possible solution
	Coolant Stop, engine off	The coolant is too hot.	<ul style="list-style-type: none"> ▶ Stop the vehicle in a safe location or as soon as it is safe to do so and turn off the engine. ▶ Only start the engine again after the message disappears. You could otherwise damage the engine.

Warning!



Driving when your engine is badly overheated can cause some fluids which may have leaked into the engine compartment to catch fire. You could be seriously burned.

Steam from an overheated engine can cause serious burns and can occur just by opening the hood. Stay away from the engine if you see or hear steam coming from it.

Turn off the engine, get out of the vehicle and do not stand near the vehicle until the engine has cooled down.





During severe operating conditions and stop-and-go city traffic, the coolant temperature may rise close to 248°F (120°C).



The engine should not be operated with the coolant temperature above 248°F (120°C). Doing so may cause serious engine damage which is not covered by the Mercedes-Benz Limited Warranty.

Display symbol	Display message	Possible cause/consequence	Possible solution
	Coolant Stop, engine off	The poly-V-belt could be broken.	<ul style="list-style-type: none"> ▶ Stop the vehicle in a safe location or as soon as it is safe to do so and immediately turn off the engine. ▶ Check the poly-V-belt. <p>If it is broken:</p> <ul style="list-style-type: none"> ▶ Do not continue to drive. Otherwise the engine will overheat due to an inoperative water pump which may result in damage to the engine. Notify an authorized Mercedes-Benz Center. <p>If it is intact:</p> <ul style="list-style-type: none"> ▶ Do not continue to drive the vehicle with this message displayed. Doing so could result in serious engine damage that is not covered by the Mercedes-Benz Limited Warranty. ▶ Drive immediately to the nearest authorized Mercedes-Benz Center.
	Coolant Visit workshop	The cooling fan for the coolant is malfunctioning.	<ul style="list-style-type: none"> ▶ Observe the coolant temperature display. ▶ Have the fan replaced as soon as possible.

What to do if ...?

Display symbol	Display message	Possible cause/consequence	Possible solution
	Check gas cap See Oper.'s Man.	A loss of pressure has been detected in the fuel system. The fuel cap may not be closed properly or the fuel system may be leaky.	<ul style="list-style-type: none"> ▶ Check the fuel cap (▷ page 318). If it is not closed properly: <ul style="list-style-type: none"> ▶ Close the fuel cap. If it is closed properly: <ul style="list-style-type: none"> ▶ Have the fuel system checked by an authorized Mercedes-Benz Center.
	Display malfunction Visit workshop	<p>The instrument cluster display is malfunctioning.</p> <p>The displays for several systems have malfunctioned. Some systems themselves may also have malfunctioned.</p>	<ul style="list-style-type: none"> ▶ Continue driving with added caution. ▶ Visit an authorized Mercedes-Benz Center as soon as possible. ▶ Have the electronic systems checked by an authorized Mercedes-Benz Center.
	Display defective Visit workshop	<p>Certain electronic systems are unable to relay information to the control system. The following systems may have failed:</p> <ul style="list-style-type: none"> • Coolant temperature display • Tachometer • Cruise control display 	<ul style="list-style-type: none"> ▶ Have the electronic systems checked by an authorized Mercedes-Benz Center.
	Doors open	You are attempting to drive with one or more doors open.	<ul style="list-style-type: none"> ▶ Close the doors.

Display symbol	Display message	Possible cause/consequence	Possible solution
	<p>USA only: Add 1 qt. engine oil at next refueling</p> <p>Canada only: Add 1 liter engine oil at next refueling</p>	The engine oil level is too low.	▶ Add engine oil (▷ page 325) and check the engine oil level (▷ page 323).
	<p>Engine oil level Reduce oil level</p>	You have added too much engine oil. There is a risk of damaging the engine or the catalytic converter.	▶ Have oil siphoned or drained off. Observe all legal requirements with respect to its disposal.
	<p>Engine oil level Stop, engine off</p>	There is no oil in the engine. There is a danger of engine damage.	<p>▶ Carefully bring the vehicle to a halt as soon as possible.</p> <p>▶ Turn off the engine.</p> <p>▶ Add engine oil (▷ page 325) and check the engine oil level (▷ page 323).</p>

What to do if ...?

Display symbol	Display message	Possible cause/consequence	Possible solution
	Engine oil level Visit workshop	The engine oil has dropped to a critical level.	<ul style="list-style-type: none"> ▶ Check the engine oil level (▷ page 323) and add oil as required (▷ page 325). ▶ If you must add engine oil frequently, have the engine checked for possible leaks.
		The measuring system is malfunctioning.	<ul style="list-style-type: none"> ▶ Have the measuring system checked by an authorized Mercedes-Benz Center.



When the message Add 1 qt. engine oil at next refueling (Canada: 1 liter) appears while the engine is running and at operating temperature, the engine oil level has dropped to approximately the minimum level.

When this occurs, the warning will first come on intermittently and then stay on if the oil level drops further.



Visually check for oil leaks. If no obvious oil leaks are noted, drive to the nearest service station where the engine oil should be topped to the required level with an approved oil specified in the Factory Approved Service Products pamphlet.



The engine oil level warnings should not be ignored. Extended driving with the symbol displayed could result in serious engine damage that is not covered by the Mercedes-Benz Limited Warranty.

Display symbol	Display message	Possible cause/consequence	Possible solution	
	Reserve fuel	The fuel level has dropped below the reserve mark.	▶ Refuel at the next gas station (▷ page 318).	
	Hood open	You are driving with the hood open.	▶ Close the hood (▷ page 322).	
	Remove key	You have forgotten to remove the SmartKey.	▶ Remove the SmartKey from the starter switch.	
	Replace key	No additional code available for SmartKey or SmartKey with KEYLESS-GO*.	▶ Visit an authorized Mercedes-Benz Center as soon as possible.	
	Key Check battery	The SmartKey with KEYLESS-GO* batteries are discharged.	▶ Change the batteries (▷ page 435).	
	Key not recognized		The SmartKey with KEYLESS-GO* is not recognized while the engine is running because <ul style="list-style-type: none"> • the SmartKey is not in the vehicle • there is strong radio-frequency interference 	▶ Stop the vehicle as soon as it is safe to do so. ▶ Search for the SmartKey. Otherwise the vehicle cannot be centrally locked nor can the engine be started again after the engine has been stopped.
			The SmartKey with KEYLESS-GO* is momentarily not recognized.	▶ Change the position of the SmartKey in the vehicle. ▶ Operate the vehicle with the SmartKey in the starter switch if necessary.
Keyless Go Check system	The KEYLESS-GO* system is malfunctioning.	▶ Visit an authorized Mercedes-Benz Center as soon as possible.		

What to do if ...?

Display symbol	Display message	Possible cause/consequence	Possible solution
	Key recognized in vehicle	A SmartKey with KEYLESS-GO* left in the vehicle was recognized while locking the vehicle from the outside.	▶ Take the SmartKey out of the vehicle.
	Key do not forget key	This display appears (for a maximum of 60 seconds) if the driver's door is opened with the engine shut off and no SmartKey in the starter switch. Message is only a reminder.	▶ Insert SmartKey in the starter switch. ▶ Take the SmartKey with KEYLESS-GO* with you when leaving the vehicle.
	Active Light System currently unavailable	The Bi-Xenon cornering lamps system is malfunctioning.	▶ Visit an authorized Mercedes-Benz Center as soon as possible.
	Active Light System malfunction Drive to workshop	The Bi-Xenon cornering lamps system is malfunctioning.	▶ Visit an authorized Mercedes-Benz Center as soon as possible.
	Active Light System Substitute bulb on	The active headlamps are malfunctioning. Another light is being used.	▶ Visit an authorized Mercedes-Benz Center as soon as possible.
	3rd brake lamp	The high mounted brake lamp is malfunctioning.	▶ Visit an authorized Mercedes-Benz Center as soon as possible.
	Brake lamp Drive to workshop	Stop lamp illumination is delayed or lamp is permanently on.	▶ Visit an authorized Mercedes-Benz Center as soon as possible.
	Brake lamp, left	The left brake lamp is malfunctioning.	▶ Visit an authorized Mercedes-Benz Center as soon as possible.

Display symbol	Display message	Possible cause/consequence	Possible solution
	Brake lamp, right	The right brake lamp is malfunctioning.	▶ Visit an authorized Mercedes-Benz Center as soon as possible.
	Display malfunction Visit workshop	The display for the lamps or the system is malfunctioning.	▶ Visit an authorized Mercedes-Benz Center as soon as possible.
	Front foglamp, left	The left front fog lamp is malfunctioning.	▶ Replace the bulb as soon as possible.
	Front foglamp, right	The right front fog lamp is malfunctioning.	▶ Replace the bulb as soon as possible.
	High beam, left	The left high beam lamp is malfunctioning.	▶ Replace the bulb as soon as possible.
	High beam, right	The right high beam lamp is malfunctioning.	▶ Replace the bulb as soon as possible.
	Lamp sensor Drive to workshop	The lamp sensor is malfunctioning. The headlamps switch on automatically.	▶ In the control system, set lamp operation to manual (▷ page 156). ▶ Switch on headlamps using the exterior lamp switch. ▶ Visit an authorized Mercedes-Benz Center as soon as possible.
	License plate lamp, left	The left license plate lamp is malfunctioning.	▶ Replace the bulb as soon as possible.
License plate lamp, right	The right license plate lamp is malfunctioning.	▶ Replace the bulb as soon as possible.	





What to do if ...?

Display symbol	Display message	Possible cause/consequence	Possible solution
	Low beam, left	The left low beam lamp is malfunctioning.	Halogen headlamp: ▶ Replace the bulb as soon as possible. Bi-Xenon* headlamp: ▶ Visit an authorized Mercedes-Benz Center as soon as possible.
	Low beam, right	The right low beam lamp is malfunctioning.	Halogen headlamp: ▶ Replace the bulb as soon as possible. Bi-Xenon* headlamp: ▶ Visit an authorized Mercedes-Benz Center as soon as possible.
	Parking lamp front left	The left front parking lamp is malfunctioning.	▶ Visit an authorized Mercedes-Benz Center as soon as possible.
	Parking lamp front right	The right front parking lamp is malfunctioning.	▶ Visit an authorized Mercedes-Benz Center as soon as possible.
	Rear foglamp back-up lamp on	The foglamp is malfunctioning. A back-up bulb is being used.	▶ Visit an authorized Mercedes-Benz Center as soon as possible.
	Reverse lamp, left	The left backup lamp is malfunctioning.	▶ Replace the bulb as soon as possible.
	Reverse lamp, right	The right backup lamp is malfunctioning.	▶ Replace the bulb as soon as possible.

Display symbol	Display message	Possible cause/consequence	Possible solution
	Side marker lamp front left	The front left side marker lamp is malfunctioning.	▶ Visit an authorized Mercedes-Benz Center as soon as possible.
	Side marker lamp front right	The front right side marker lamp is malfunctioning.	▶ Visit an authorized Mercedes-Benz Center as soon as possible.
	Tail lamp left back-up lamp on	The left tail lamp is malfunctioning. A back-up bulb is being used.	▶ Visit an authorized Mercedes-Benz Center as soon as possible.
	Tail lamp right back-up lamp on	The right tail lamp is malfunctioning. A back-up bulb is being used.	▶ Visit an authorized Mercedes-Benz Center as soon as possible.
	Turn off lamps	Lamps have been turned on although the SmartKey in the starter switch is in position 0 .	▶ Turn off the headlamps.
	Turn signal, front left	The left front turn signal lamp is malfunctioning.	▶ Replace the bulb as soon as possible.
	Turn signal, front right	The right front turn signal lamp is malfunctioning.	▶ Replace the bulb as soon as possible.
	Turn signal, left mirror	The left turn signal in the side mirror is malfunctioning. This message will only appear if all light emitting diodes have stopped working.	▶ Have the LEDs replaced as soon as possible.

What to do if ...?

Display symbol	Display message	Possible cause/consequence	Possible solution
	Turn signal, right mirror	The right turn signal in the side mirror is malfunctioning. This message will only appear if all light emitting diodes have stopped working.	▶ Have the LEDs replaced as soon as possible.
	Turn signal rear left back-up lamp on	The left rear turn signal lamp is malfunctioning. A back-up bulb is being used.	▶ Replace the bulb as soon as possible.
	Turn signal rear right back-up lamp on	The right rear turn signal lamp is malfunctioning. A back-up bulb is being used.	▶ Replace the bulb as soon as possible.
	Please engage roll-over bar	The roll bar is malfunctioning.	▶ Have the system checked at an authorized Mercedes-Benz Center as soon as possible.
	Please release roll-over bar	The roll bar is malfunctioning.	▶ Operate the roll bars manually (▷ page 423). ▶ Have the system checked at an authorized Mercedes-Benz Center as soon as possible.

Display symbol	Display message	Possible cause/consequence	Possible solution
	Lock driver's seat	The driver seat backrest is not engaged.	Fold back and push the seat backrest until the seat cushion and seat backrest audibly engage into the driving position.
	Lock front passenger seat	The passenger seat backrest is not engaged.	Fold back and push the seat backrest until the seat cushion and seat backrest audibly engage into the driving position.
	Seat belt system Drive to workshop	The seat belt system is malfunctioning.	► Visit an authorized Mercedes-Benz Center as soon as possible.
	Tele Aid malfunction Drive to workshop	One or more main functions of the Tele Aid system are malfunctioning.	► Have the Tele Aid system checked by an authorized Mercedes-Benz Center.
	Restraint system defective Drive to workshop	The system is malfunctioning.	► Drive with added caution to the nearest authorized Mercedes-Benz Center.

Warning!





In the event a malfunction of the SRS is indicated as outlined above, the SRS may not be operational.

For your safety, we strongly recommend that you visit an authorized Mercedes-Benz

Center immediately to have the system checked; otherwise the SRS may not be deploy when needed in an accident, which could result in serious or fatal injury, or it might deploy unexpectedly and unnecessarily which could also result in injury.

What to do if ...?

Display symbol	Display message	Possible cause/consequence	Possible solution
	Lock top	The soft top is not properly locked.	▶ Lock the soft top again (▷ page 259).
	Top being opened	The soft top is not completely open or closed. The hydraulics are losing pressure.	▶ Open or close the soft top all the way.
	Top Visit workshop	The soft top is malfunctioning.	▶ Have the system checked at an authorized Mercedes-Benz Center as soon as possible.
	Start engine to operate top	The on-board voltage is too low.	▶ Start the engine.
	Top locked as vehicle is moving	You have attempted to open or close the soft top while driving.	▶ Pull over to the side of the road and repeat soft top operation while the vehicle is stationary.
	Steering oil Visit workshop	The steering gear oil level is too low. There is a danger of steering gear damage.	▶ Have the system checked by an authorized Mercedes-Benz Center.





Warning!





If the level of steering gear oil in reservoir is too low, the steering power assistance could fail. Much greater effort will then be needed to turn the steering wheel.

Do not add steering oil without checking the steering system.

Do not drive the vehicle. Have the system checked at an authorized Mercedes-Benz Center as soon as possible.

Display symbol	Display message	Possible cause/consequence	Possible solution
	Function Unavailable	This display appears if button  or  on the multifunction steering wheel is pressed and the vehicle is not equipped with a telephone.	
	Tire pressure Check tires	The Run Flat Indicator* indicates that the pressure is too low in one or more tires.	<ul style="list-style-type: none"> ▶ Carefully bring the vehicle to a halt, avoiding abrupt steering and braking maneuvers. Observe the traffic situation around you. ▶ Check and adjust tire inflation pressure as required (▷ page 341). ▶ If necessary, change the wheel (▷ page 446). ▶ Reactivate the Run Flat Indicator* after adjusting the tire inflation pressure values (▷ page 343).

What to do if ...?

Display symbol	Display message	Possible cause/consequence	Possible solution
	Trunk open	This message will appear whenever the trunk is open.	▶ Close the trunk.
	Close trunk lid	This message will appear when the soft top is operated with the trunk open.	▶ Close the trunk.
	Trunk partitioner Please close	This message will appear when the soft top is operated with the luggage cover open.	▶ Fold down and latch luggage cover (▷ page 262).
	Washer fluid Check level	The fluid level has dropped to about $\frac{1}{3}$ of total reservoir capacity.	▶ Add washer fluid (▷ page 329).

▼ Where will I find...?

First aid kit

The first aid kit is located in the trunk on the right side secured by a hook and loop fastener.



- ① First aid kit
- ② Hook and loop fastener

- ▶ Loosen hook and loop fastener ②.
- ▶ Remove first aid kit ①.



Check expiration dates and contents for completeness at least once a year and replace missing/expired items.

Vehicle tool kit

The vehicle tool kit is stored in the compartment underneath the trunk floor.

The following is included:

- Towing eye bolt
- Wheel wrench
- Alignment bolt
- Vehicle jack
- Collapsible wheel chock
- Spare fuses
- Fuse extractor
- Straps for soft top emergency operation
- A pair of gloves

The spare wheel bolts are fixed at the Minispare wheel.



Hex wrench:

You will find the hex wrench for manually operating the roll bars (▷ page 423) or the soft top (▷ page 425) at the lower edge of the storage well casing.

Where will I find...?

Removing the vehicle tool kit

- ▶ Lift up trunk floor cover and engage trunk floor handle in upper edge of trunk.

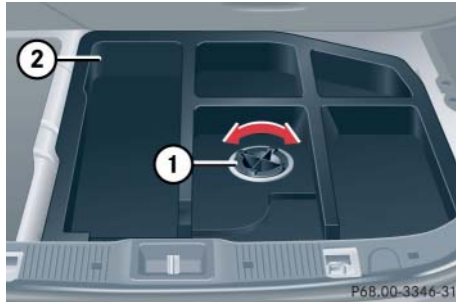

- ① Retaining screw
- ② Storage well casing

- ▶ Loosen retaining screw ① in the middle of storage well casing ② by turning it counterclockwise.
- ▶ Remove storage well casing ②.



- ③ Arrow
- ④ Minispare wheel
- ⑤ Vehicle tool kit storage well casing
- ⑥ Vehicle tool kit

- ▶ Remove vehicle tool kit ⑥.

Storing the vehicle tool kit

- ▶ Place vehicle tool kit ⑥ in vehicle tool kit storage well casing ⑤.
- ▶ Place storage well casing ② over the vehicle tool kit storage well casing ⑤ and turn retaining screw ① clockwise as far as it will go to secure the Minispare wheel.



Arrow ③ on vehicle tool kit storage well casing ⑤ must point in the direction of travel. Otherwise you cannot place the storage well casing ② on top and secure the Minispare wheel with retaining screw ①.

- ▶ Disengage trunk floor handle in upper edge of trunk and lower trunk floor cover.



To prevent damage, always disengage trunk floor handle from upper edge of trunk and lower trunk floor before closing the trunk.

Vehicle jack

Warning!



The jack is designed exclusively for jacking up the vehicle at the jack take-up brackets built into both sides of the vehicle. To help avoid personal injury, use the jack only to lift the vehicle during a wheel change. Never get beneath the vehicle while it is supported by the jack. Keep hands and feet away from the area under the lifted vehicle. Always firmly set parking brake and block wheels before raising vehicle with jack.

Do not disengage parking brake while the vehicle is raised. Be certain that the jack is always vertical (plumb line) when in use, especially on hills. Always try to use the jack on a level surface. Make sure the jack arm is fully seated in the jack take-up bracket. Always lower the vehicle onto sufficient capacity jackstands before working under the vehicle.

The vehicle jack is located in the storage compartment underneath the trunk floor.

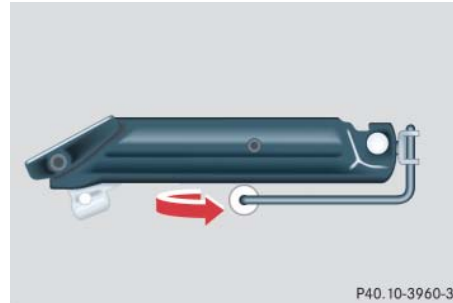

P40.10-3960-31

Storage position

- ▶ Remove vehicle jack from its compartment.
- ▶ Turn crank handle in direction of arrow as far as it will go.

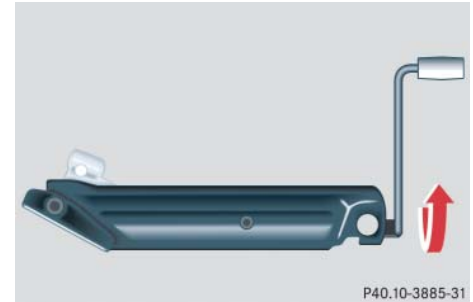

P40.10-3885-31

Operational position

- ▶ Turn crank handle clockwise.

Before storing the vehicle jack in its compartment:

- It should be fully collapsed
- The handle must be folded in (storage position)

Where will I find...?

Setting up the collapsible wheel chock

The collapsible wheel chock serves to additionally secure the vehicle, e.g. while changing the wheel.

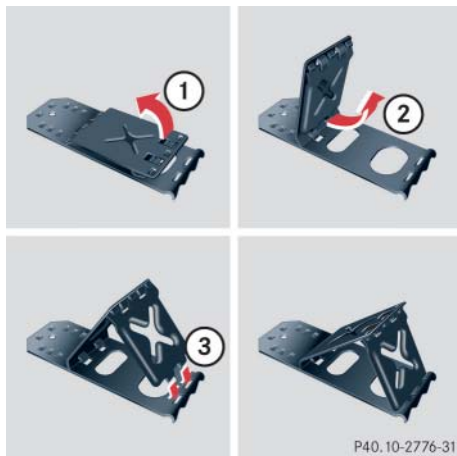

- ① Tilt the plate upward
- ② Fold the lower plate outward
- ③ Insert the plate

- ▶ Tilt both plates upward ①.
- ▶ Fold the lower plate outward ②.
- ▶ Guide the tabs of the lower plate all the way into the openings of the base plate ③.

Minispare wheel

The Minispare wheel is located in the storage compartment underneath the trunk floor.

Removing the Minispare wheel

- ▶ Lift up trunk floor cover and engage trunk floor handle in upper edge of trunk.
- ▶ Loosen the retaining screw in the middle of storage well casing by turning it counterclockwise (▷ page 414).
- ▶ Remove the storage well casing (▷ page 414).



- ① Vehicle tool kit
Wheel wrench
Jack
 - ② Arrow
 - ③ Minispare wheel, Wheel bolts for
Minispare wheel
 - ④ Vehicle tool kit storage well casing
- ▶ Remove vehicle tool kit storage well casing ④.
 - ▶ Remove Minispare wheel ③.

Storing the Minispare wheel

- ▶ Place Minispare wheel ③ in wheel well.
- ▶ Place vehicle tool kit storage well casing ④ over the Minispare wheel.
Make sure arrow ② on vehicle tool kit storage well casing ④ points in the direction of travel.
- ▶ Place storage well casing (▷ page 414) over the vehicle tool kit storage well casing ④ and turn the retaining screw (▷ page 414) clockwise as far it will go to secure the Minispare wheel.



Arrow ② on vehicle tool kit storage well casing ④ must point in the direction of travel. Otherwise you cannot place the storage well casing (▷ page 414) on top and secure the Minispare wheel with the retaining screw (▷ page 414).

- ▶ Disengage trunk floor handle in upper edge of trunk and lower trunk floor cover.



To prevent damage, always disengage trunk floor handle from upper edge of trunk and lower trunk floor before closing the trunk.

Warning!



The dimensions of the Minispare wheel are different from those of the road wheels. As a result, the vehicle handling characteristics change when driving with a Minispare wheel mounted.

The Minispare wheel should only be used temporarily, and should be replaced with a regular road wheel as quickly as possible.

Do not switch off the ESP® when a Minispare wheel is mounted.

Where will I find...?

In case of a flat tire, you may temporarily use the Minispare wheel when observing the following restrictions:

- Do not exceed a vehicle speed of 50 mph (80 km/h).
- Drive to the nearest tire repair facility to have the flat tire repaired or replaced as appropriate.
- Do not operate vehicle with more than one Minispare wheel mounted.

For more information, see “Rims and tires” (> page 471).

Spare wheel bolts

The spare wheel bolts are fixed at the Minispare wheel.

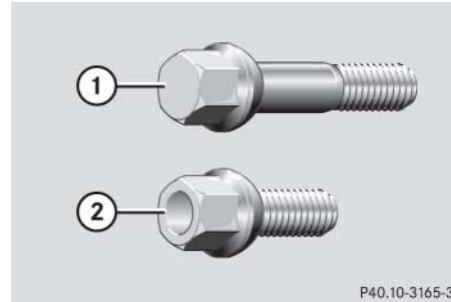

- ① Wheel bolt for light alloy rims
- ② Wheel bolt for Minispare wheel (located in trunk with spare wheel)



Wheel bolts ② must be used when mounting the Minispare wheel, or other steel rims. The use of any wheel bolts other than wheel bolts ② for the Minispare wheel will physically damage the vehicle's brakes.

Warning!



Make sure to use the original length wheel bolts when remounting the original wheel after it has been repaired.

Unlocking/locking in an emergency

▼ **Unlocking/locking in an emergency**

Unlocking the vehicle

If you are unable to unlock the vehicle with the SmartKey or KEYLESS-GO*, open the driver's door and the trunk using the mechanical key.



Unlocking and opening the driver's door and/or the trunk with the mechanical key will trigger the anti-theft alarm system.

To cancel the alarm, do one of the following:

- Press button or on the SmartKey.
- Insert the SmartKey in the starter switch.

Vehicles with KEYLESS-GO*:

- Pull the outside door handle.
- Press the KEYLESS-GO* start/stop button (▷ page 35).



- ① Mechanical key locking tab
- ② Mechanical key

- ▶ Move locking tab ① in direction of arrow.
- ▶ Slide mechanical key ② out of the housing.

Unlocking the driver's door

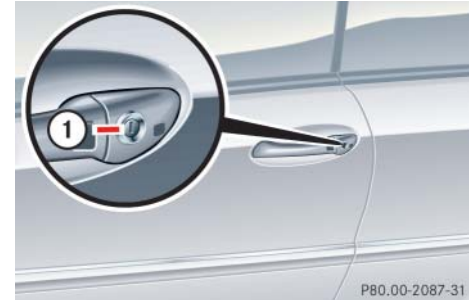

- ① Unlocking

- ▶ Insert the mechanical key into the driver's door lock until it stops.
- ▶ Turn the mechanical key counterclockwise to position ①.

The driver's door is unlocked.

Unlocking/locking in an emergency

Unlocking the trunk

A minimum height clearance of 5.41 ft (1.65 m) is required to open the trunk lid.

The trunk lid lock is located next to the handle above the rear license plate recess.

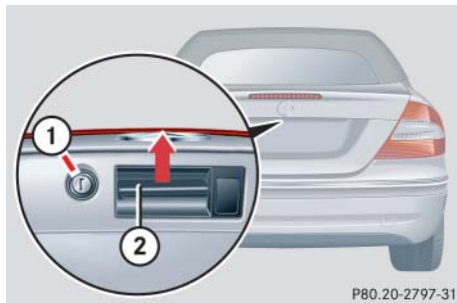

- ① Unlocking in an emergency
- ② Handle

- ▶ Insert the mechanical key into the trunk lid lock until it stops.
- ▶ Turn the mechanical key counterclockwise to position ① and hold it in this position.
- ▶ Pull the trunk lid handle ② and lift the trunk lid.

The trunk opens.



The trunk lid swings open upwards automatically. Always make sure there is sufficient overhead clearance.

- ▶ Turn the mechanical key back and remove it from the trunk lid lock.

Locking the vehicle

If you cannot lock the vehicle with the SmartKey or SmartKey with KEYLESS-GO*, do the following:

- ▶ Close the passenger door and the trunk.
- ▶ Press the central locking switch in the center console (▷ page 118).
- ▶ Check to see whether the locking knob on the passenger door has moved down.
- ▶ If necessary, push it down manually.
- ▶ Remove the mechanical key out of the SmartKey (▷ page 419).
- ▶ Check whether the trunk is locked.
- ▶ If necessary, lock the trunk with the mechanical key (▷ page 116).

Except for the driver's door, the vehicle should now be locked.

Unlocking/locking in an emergency

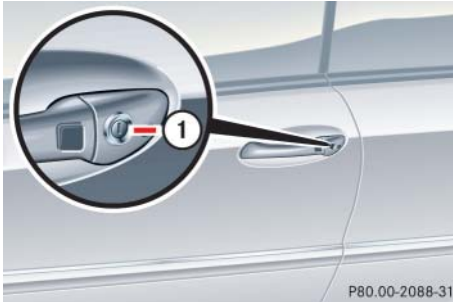

① Locking

- ▶ Insert the mechanical key into the driver's door lock until it stops.
- ▶ Turn the mechanical key clockwise to position ①.

The driver's door is locked.

Fuel filler flap

In case the central locking system does not release the fuel filler flap, you can open it manually.

Warning!



If you operate the emergency release button, be careful of the sharp edges so that you do not injure yourself.

The release button is on the right-hand side of the luggage compartment behind the side trim.

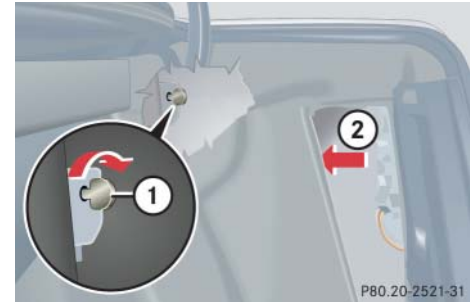

- ▶ Open trunk lid.
- ▶ Remove the side trim from the right-hand side of the luggage compartment.
- ▶ Reach inside through opening ② in direction of arrow.
- ▶ Turn release knob ① clockwise (arrow) as far as will go.

The fuel filler flap is released and can be opened from outside.

- ▶ Open the fuel filler flap from outside.

Unlocking/locking in an emergency

Manually unlocking the gear selector lever

In case of power failure, the gear selector lever can be manually unlocked, e.g. to tow the vehicle.



The gear selector lever is locked again when moving it to position **P**.

Center armrest design A

- ▶ Open the storage compartment under the center armrest (▷ page 281).

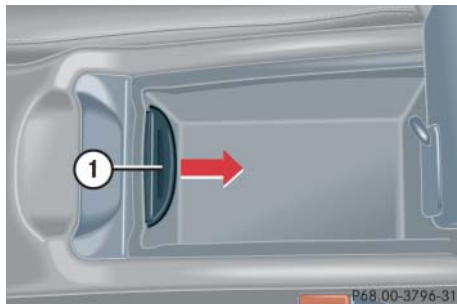

- ▶ Take out storage box ①.

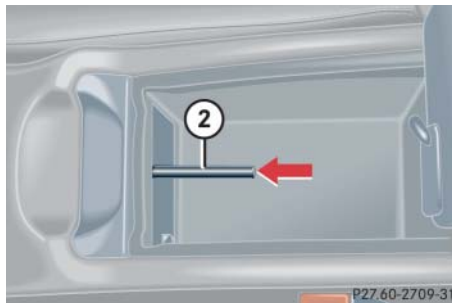

- ▶ Insert a tool ② (e.g. flat blade screwdriver) into the opening.
- ▶ Perform the following two steps simultaneously:
 - ▶ Press tool ② forward in the direction of the arrow.
 - ▶ Move selector lever from position **P**.
- ▶ Reinstall the storage box ① after removing the tool ② from the opening.

Center armrest design B

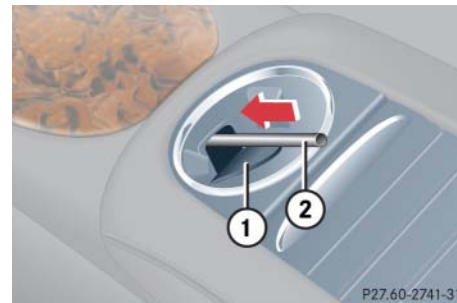

- ▶ Pull the tab ① of the covering back in direction of the center armrest compartment.
- ▶ Insert a tool ② (e.g. flat blade screwdriver) into the opening.
- ▶ Perform the following two steps simultaneously:
 - ▶ Push tool ② down- and forward in the direction of the arrow.
 - ▶ Move gear selector lever from position **P**.
- ▶ Remove the tool ② from the opening.
- ▶ Push the tab ① of the covering back.

Opening/closing in an emergency

▼ Opening/closing in an emergency

Operating roll bars manually

Releasing roll bars manually

If the roll bar system is malfunctioning, you can release the roll bars manually.

Warning!



If the yellow roll bar warning lamp  in the clock does not go out after starting the engine, or if it comes on while driving, then the roll bar system is not operating properly and may not activate in an accident. In this case, raise the roll bars manually before continuing to drive.

For safety reasons drive only with the roll bars raised until the malfunction is repaired. Have your vehicle checked at an authorized Mercedes-Benz Center.

- ▶ Close the soft top (▷ page 257).



With the roll bars released, the soft top cannot be operated using the soft top switch and the rear head restraints cannot be lowered using the rear head restraint lowering switch.

- ▶ Open the trunk (▷ page 108).
- ▶ Fold back the luggage cover (▷ page 262).
- ▶ Take hex wrench out of its storage location in the storage well casing (▷ page 413).

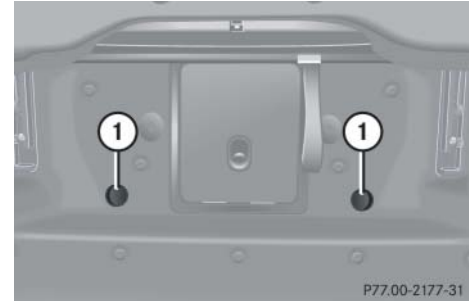

- ① Perforation
- ▶ Push hex wrench through perforation ① in trim of rear wall in trunk.

Warning!



Make sure no one is located in the roll bar's path of motion while the next steps are being carried out.

When the roll bar is manually released, the rear head restraints and the roll bar underneath shoot up almost instantaneously.



Opening/closing in an emergency

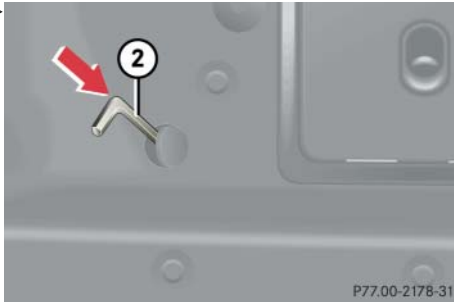

② Hex wrench

- ▶ Insert long side of hex wrench ② into opening.
- ▶ Using hex wrench ②, press release catch down in direction of arrow.
The roll bar extends with a loud sound.
- ▶ Repeat this step for the second roll bar.

Have the systems checked at an authorized Mercedes-Benz Center as soon as possible.

Lowering roll bars manually

With the soft top open, you can lower the roll bars manually after they have been released.



With the roll bars released, the soft top cannot be operated using the soft top switch and the rear head restraints cannot be lowered using the rear head restraint lowering switch.

Warning!



Never lower the roll bars manually unless the soft top is open. Otherwise, the roll bars function could be impaired, no longer reducing your risk of injury in an optimal manner.

Contact an authorized Mercedes-Benz Center to have the roll bar lowered when the soft top is closed.

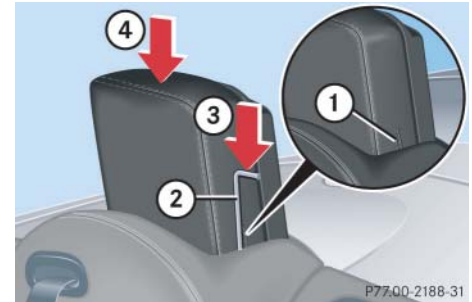

- ① Orientation seam
- ② Hex wrench
- ③ Press wrench down
- ④ Press head restraint down

- ▶ Take hex wrench out of its storage location in the storage well casing (▷ page 413).
- ▶ Align hex wrench so that its long side is parallel to orientation seam ① and insert hex wrench ② into gap on left side of respective head restraint.

Opening/closing in an emergency

- ▶ Press hex wrench down firmly in direction of arrow ③ and hold.
- ▶ Press head restraint down in direction of arrow ④.
- ▶ Pull hex wrench ② out and take weight off head restraint.
- ▶ Repeat this procedure on roll bar for second head restraint.

Soft top emergency operation

If the soft top cannot be automatically closed, check the following:

- Is the luggage cover engaged in place (▷ page 262)?
- Have the roll bars been released? If so, lower the roll bars manually (▷ page 424).
- Is the trunk lid closed (▷ page 110)?
- Is there sufficient on-board voltage? Start the engine if necessary.

These messages will also appear in the multifunction display (▷ page 410).

If automatic operation still does not function properly, you can close the soft top manually.

This procedure should be performed with great care by two persons.



Manually closing the soft top is a complicated and technically demanding procedure. Close the soft top manually in emergency cases only. Otherwise, visit an authorized Mercedes-Benz Center. Please read the instructions fully before beginning operation and only undertake it with another person and if you feel fully capable of performing the tasks involved.

Warning!



- It is important that a second person helps you. Otherwise, you could become trapped or injured.
- Remove any wristwatches or jewelry such as rings or bracelets. Otherwise, they could get caught in the vehicle mechanism, causing personal injury to yourself or damage to the vehicle.
- Always use the grips provided as indicated. Otherwise you could injure yourself.

Opening/closing in an emergency

- ▶ Engage parking brake.
- ▶ Lower the side windows.
- ▶ Lower rear head restraints (▷ page 120).



If the rear head restraints cannot be lowered using the rear head restraint lowering switch, the roll bars may have been released. For more information, see “Operating roll bars manually” (▷ page 423).

- ▶ For safety reasons, remove SmartKey from starter switch.
- ▶ Open the trunk.
- ▶ Remove the trunk floor cover.
- ▶ Take the two straps for soft top emergency operation out of vehicle tool kit (▷ page 413).
- ▶ Take hex wrench out of its storage location in the storage well casing (▷ page 413).
- ▶ Open the left side trim panel in the trunk.

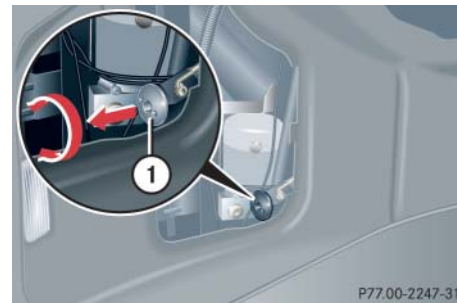

① Locking mechanism

- ▶ Pull locking mechanism ① out until it stops and rotate it approx. one-quarter of a turn.
- ▶ Make sure the locking mechanism does not retract again. If this happens, pull the locking mechanism out again and rotate it approx. one-quarter of a turn.

Opening/closing in an emergency

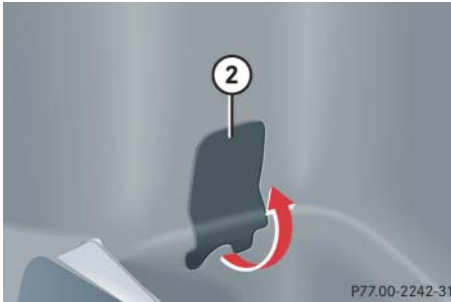

② Trim

- ▶ Fold the right-hand side of the trunk floor away.
- ▶ Detach trim ② along the perforation.

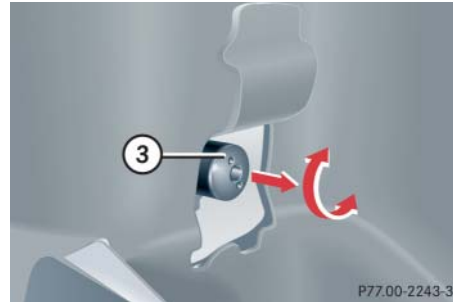

③ Locking mechanism

- ▶ Pull locking mechanism ③ out until it stops and rotate it approx. one-quarter of a turn.
- ▶ Make sure the locking mechanism does not retract again. If this happens, pull the locking mechanism out again and rotate it approx. one-quarter of a turn.

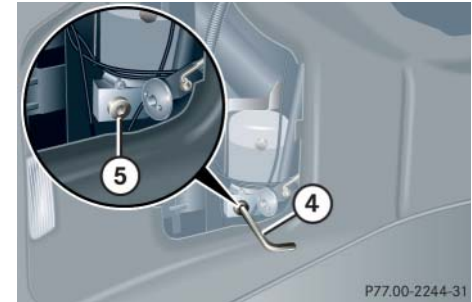

④ Hex wrench

⑤ Screw of hydraulic pump

- ▶ Insert hex wrench ④ into screw ⑤.
- ▶ Turn hydraulic pump screw ⑤ counter-clockwise one revolution with hex wrench ④.



Do not operate the soft top switch with screw ⑤ in the opened position, otherwise the hydraulic pump could be damaged.



Opening/closing in an emergency

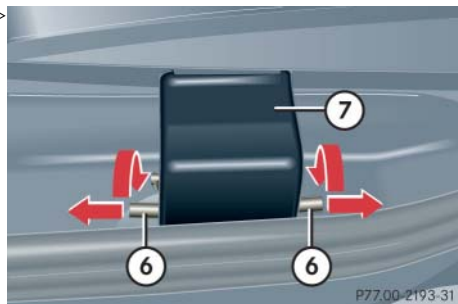

⑥ Lever

⑦ Soft top storage compartment hinge

The soft top storage compartment hinges are located on the left and right of the space between the soft top compartment cover and the trunk seal.

- ▶ Pull the two levers ⑥ apart and fold levers ⑥ of soft top storage compartment hinge ⑦ forward on both sides over the detent position.

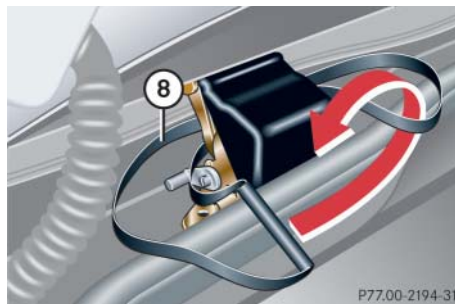

⑧ Strap

- ▶ Pull strap ⑧, supplied in vehicle tool kit, behind soft top storage compartment through hinge ⑦.
- ▶ Bring strap together in front of hinge.
- ▶ Pull the side with the handle through the loop on the opposite side.



- ▶ Pull strap between soft top storage compartment hinge and soft top compartment.
- ▶ Secure second strap to second hinge in the same manner.



Do not pull the straps when the trunk is open.

Opening/closing in an emergency



- ▶ Place both straps on soft top compartment cover.
- ▶ Take hex wrench out of trunk.
- ▶ Close trunk lid.

You will only have access to the trunk again when the emergency operation has been completed.



Do not place the SmartKey in the open trunk. You may lock yourself out.

Vehicles with KEYLESS-GO*: To prevent a possible inadvertent lockout, the trunk lid will open automatically if a SmartKey with KEYLESS-GO* is recognized in the area of the rear shelf or inside the trunk.



The trunk lid must remain closed during the next steps in the procedure. Otherwise the trunk lid and the soft top compartment cover may come into contact with one another and be damaged.

Warning!



At this point, the remaining procedure needs to be done by two people. Otherwise you could be injured.

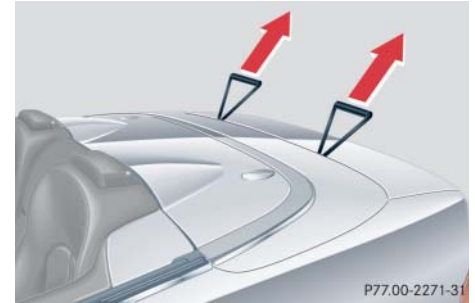

- ▶ You and your assistant should each take one of the straps by the handle.
- ▶ With a strong, simultaneous tug on the loops, pull soft top compartment cover upward and out to the rear.



Opening/closing in an emergency



⑨ Soft top compartment cover

- ▶ One person should stand on the left side of the vehicle and the other on the right side.

Warning!



In the next step, you and your assistant should each take hold of the soft top compartment cover as shown in the illustration. Both of you should use your free hand to support yourselves on the edge of the trunk lid as shown in the illustration.

If either you or your helper assume a different position, one or both of you could be trapped or injured.

- ▶ Pulling the cover back in one smooth motion, lift soft top compartment cover ⑨ into a vertical position until it stops.



Make sure the soft top storage compartment hinges do not fold down during this procedure. Otherwise your vehicle could be damaged.



⑩ Edge of soft top

- ▶ From left and right sides, reach into soft top compartment underneath edge of soft top ⑩.

Warning!



Do not place your hands near the upper windshield area, trunk lid, or between soft top roof panels and hinges while the soft top is being raised and locked. Serious personal injury may occur.

Opening/closing in an emergency



⑪ Windshield frame

- ▶ Lift soft top out of soft top compartment and pull it forward to windshield frame ⑪.

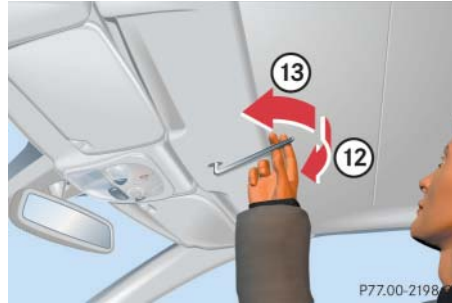

⑫ Opening

⑬ Locking

- ▶ Take off protective cap on the inner side of the soft top.
- ▶ Insert hex wrench into soft top locking mechanism screw.
- ▶ Turn the soft top locking mechanism screw with hex wrench clockwise in direction of arrow ⑫ as far as it will go.
The clasp will open and the soft top will engage audibly.

- ▶ Turn the soft top locking mechanism screw with hex wrench counterclockwise in direction of arrow ⑬ as far as it will go.

The clasp will close and the soft top is now locked onto the windshield frame.



Make sure you turn the hex wrench counterclockwise as far as it will go. Otherwise the soft top may not lock properly.



Opening/closing in an emergency

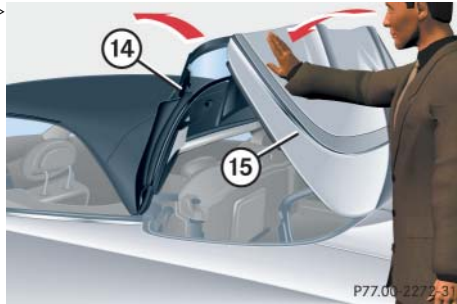

⑭ Material tensioning frame

⑮ Soft top compartment cover

- ▶ Lift material tensioning frame ⑭ into a vertical position.
- ▶ Lower soft top compartment cover ⑮.



Make sure the soft top compartment cover ⑮ does not collide or make contact with the material tensioning frame ⑭.

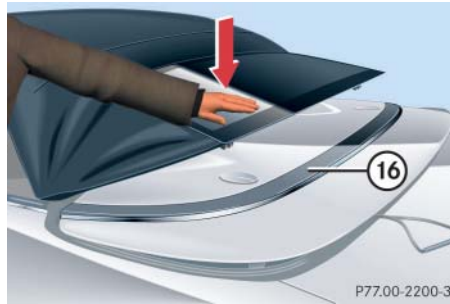

⑯ Soft top base

- ▶ With the palm of your hand, press the window in material tensioning frame ⑭ until it is positioned on the soft top base ⑯.



- ▶ You and your assistant should press soft top compartment cover ⑮ forward and down with the palms of your hands until it snaps into place in the guide. Place your hands on the areas indicated by the arrows.

At the same time, gently press material tensioning frame ⑭ down with the palms of your hands.

Opening/closing in an emergency

Warning!



Position hands as indicated by arrows so that when you press soft top compartment cover ⑮ forward and lower material tensioning frame ⑭, your hands cannot become trapped.

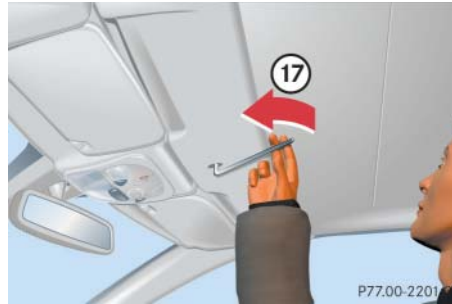

⑰ Locking

- ▶ Insert hex wrench into soft top locking mechanism screw.
- ▶ Turn the soft top locking mechanism screw with hex wrench counterclockwise in direction of arrow ⑰ as far as it will go.

The soft top is locked onto the windshield frame.



Make sure you turn the hex wrench counterclockwise as far as it will go. Otherwise the soft top may not lock properly.

- ▶ Have the soft top operation checked at an authorized Mercedes-Benz Center as soon as possible.



If, after completing the soft top emergency operation, the trunk cannot be opened using the remote trunk lid release switch in the driver's door, the  button on the SmartKey, or the trunk lid release handle in the license plate recess, press the soft top compartment cover down again as described above.

Do not open the trunk with the emergency key, as this could otherwise damage the trunk lid and the soft top compartment cover.

Resetting activated head restraints

Resetting activated head restraints

If the active head restraints have been triggered in a rear-end collision, the active head restraints must be reset. Otherwise, the active head restraints cannot offer any additional protection in the event of another rear-end collision.



For your convenience, we recommend that you have this work carried out by an authorized Mercedes-Benz Center.

You will find the reset tool for manually operating the active head restraints in the Mercedes-Benz vehicle literature pouch.

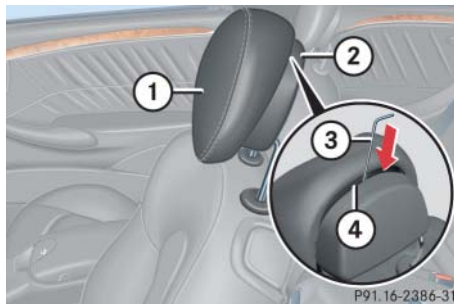

- ① Head restraint cushion
- ② Head restraint cover
- ③ Reset tool
- ④ Hole

- ▶ Take the reset tool ③ out of the Mercedes-Benz vehicle literature pouch.
- ▶ Guide reset tool ③ into the hole ④ between the rear head restraint cover ② and the head restraint cushion ①.



Be careful not to damage upholstery.

- ▶ Press the reset tool ③ downward until you hear the active head restraint release mechanism audibly engage.
- ▶ Pull out reset tool ③.
- ▶ Firmly press the head restraint cushion ① back toward the rear head restraint cover ② until it engages.

Warning!



When pushing back the head restraint cushion, take care that your fingers do not become caught between the head restraint cushion and the cover. Failing to do so may lead to injury.

- ▶ Repeat this procedure on the active head restraint for the second seat.

For information on active head restraints, see “Active head restraints” (▷ page 73).

For information on head restraint adjustment, see “Seats” (▷ page 37).

Replacing SmartKey batteries

▼ Replacing SmartKey batteries

If the batteries in the SmartKey or the SmartKey with KEYLESS-GO* are discharged, the vehicle can no longer be locked or unlocked. It is recommended to have the batteries replaced at an authorized Mercedes-Benz Center.

Warning!

Keep the batteries out of reach of children.

If a battery is swallowed, seek medical help immediately.

Batteries contain materials that can harm the environment if disposed of improperly. Recycling of batteries is the preferred method of disposal. Many states require sellers of batteries to accept old batteries for recycling.



When inserting the batteries, make sure they are clean and free of lint.



When changing batteries, always replace both batteries.

The required replacement batteries are available at any Mercedes-Benz Center.

Replacing SmartKey batteries

SmartKey

Replacement batteries: Lithium, type CR 2025 or equivalent.

- ▶ Remove the mechanical key (▷ page 419).

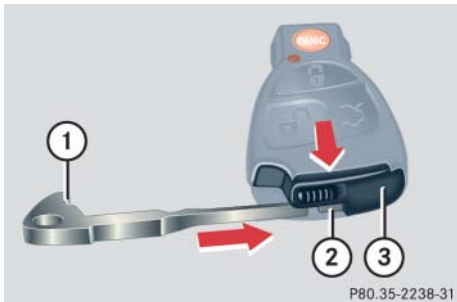

- ① Mechanical key
- ② Slide
- ③ Battery compartment

- ▶ Insert the mechanical key ① in direction of arrow in side opening.

- ▶ Using mechanical key ①, push gray slide ② to unlatch battery compartment ③.
- ▶ Pull battery compartment ③ out of the housing in the direction of arrow.

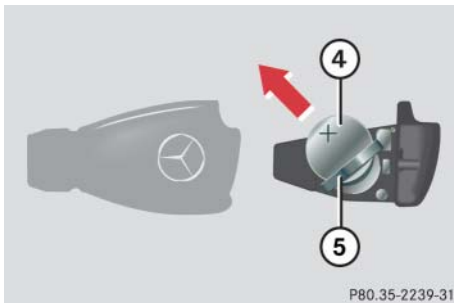

- ③ Battery
- ④ Contact spring

- ▶ Remove the batteries ④ in direction of arrow.
- ▶ Using a lint-free cloth, insert new batteries ④ under the contact spring ⑤ with the positive terminal (+) side facing up.
- ▶ Return battery compartment ③ into housing until it locks into place.
- ▶ Slide mechanical key ① back into the SmartKey.
- ▶ Check the operation of the SmartKey.

Replacing SmartKey batteries

SmartKey with KEYLESS-GO*

Replacement batteries: Lithium, type CR 2025 or equivalent.

- ▶ Remove the mechanical key (▷ page 419).
- ▶ Insert the mechanical key in side opening and push grey slide (▷ page 436).
The battery compartment is unlatched.
- ▶ Pull the battery compartment out of the housing (▷ page 436).

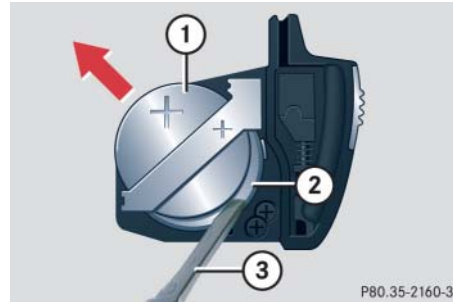

- ① Battery
 - ② Tilt battery up
 - ③ Mechanical key
- ▶ Using mechanical key ③, apply pressure to position ②.
Battery ① tilts up slightly.
 - ▶ Pull batteries ① out in direction of arrow.

- ▶ Using a lint-free cloth, insert new batteries ① under the contact spring with the positive terminal (+) side facing up.
- ▶ Return battery compartment into housing until it locks into place.
- ▶ Slide mechanical key ③ back into the SmartKey.
- ▶ Check the operation of the SmartKey and the KEYLESS-GO*.

Replacing bulbs

Safe vehicle operation depends on proper exterior lighting and signaling. It is therefore essential that all bulbs and lamp assemblies are in good working order at all times.

Correct headlamp adjustment is extremely important. Have headlamps checked and readjusted at regular intervals and when a bulb has been replaced. See an authorized Mercedes-Benz Center for headlamp adjustment.



If the headlamps or front fog lamps are fogged up on the inside as a result of high humidity, driving the vehicle a distance with the lights on should clear up the fogging.



Back-up bulbs will be brought into use when lamps malfunction. Observe the messages in the multifunction display (▷ page 404).

Bulbs



Front lamps

Lamp	Type
① Additional turn signal lamp	LED
② Turn signal lamp	1156 NA
③ Halogen headlamp: Low beam Bi-Xenon* headlamp: Low and high beam ¹	H7 (55 W) D2S-35 W
④ Halogen headlamp: High beam/high beam flasher Bi-Xenon* headlamp: High beam flasher Parking and standing lamp	H7 (55 W) H7 (55 W) W 5 W
⑤ Front fog lamp Corner-illuminating front fog lamp*	HB4 (51 W) H7 (55 W)
⑥ Side marker lamp	W 5 W

¹ Vehicles with Bi-Xenon headlamps* do not replace the Bi-Xenon bulbs yourself.

Rear lamps

Lamp	Type
⑦ High mounted brake lamp	LED
⑧ Brake lamp	P 21 W
⑨ Turn signal lamp	P 21 W
⑩ Tail, parking and standing lamp, side marker	P 21/4 W W 5 W
⑪ Backup lamp	P 21 W
⑫ License plate lamps	C 5 W
⑬ Rear fog lamp, driver's side	P 21/4 W

Warning!



Keep bulbs out of reach of children.

Bulbs and bulb sockets can be very hot. Allow the lamp to cool down before changing a bulb.

Halogen lamps contain pressurized gas. A bulb can explode if you:

- touch or move it when hot
- drop the bulb
- scratch the bulb

Wear eye and hand protection.

Because of high voltage in Xenon lamps, it is dangerous to replace the bulb or repair the lamp and its components. We recommend that you have such work done by a qualified technician.



Have the headlamp adjustment checked regularly.

Notes on bulb replacement

- Only use 12 volt bulbs of the same type and with the specified watt rating.
- Switch lights off before changing a bulb to prevent short circuits.
- Always use a clean lint-free cloth when handling bulbs.
- Your hands should be dry and free of oil and grease.
- If the newly installed bulb does not come on, visit an authorized Mercedes-Benz Center.

Have the LEDs and bulbs for the following lamps replaced by an authorized Mercedes-Benz Center.

- Additional turn signal lamps in the exterior rear view mirrors
- High mounted brake lamp
- Bi-Xenon* lamps
- Front fog lamps
- Front side marker lamps

Replacing bulbs

Replacing bulbs for front lamps

Before you start to replace a bulb for a front lamp, do the following first:

- ▶ Turn the exterior lamp switch to position **0** (▷ page 127).
- ▶ Open the hood (▷ page 321).

Front lamps halogen-type

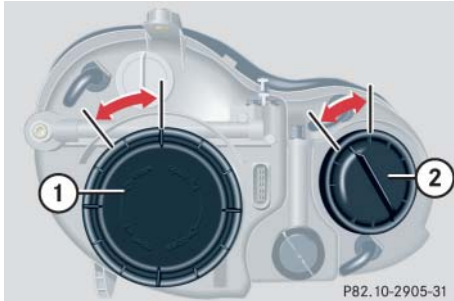

- ① Housing cover for low beam headlamp
- ② Housing cover for high beam headlamp, parking and standing lamp

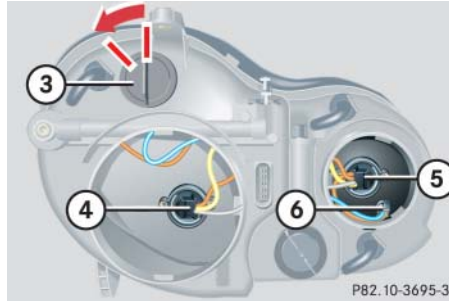

- ③ Bulb socket for turn signal lamp bulb
- ④ Bulb holder of low beam bulb
- ⑤ Bulb holder of high beam bulb
- ⑥ Bulb socket for parking and standing lamp bulb

Low beam bulb

- ▶ Turn housing cover ① counterclockwise and remove it.
- ▶ Turn bulb holder ④ with the bulb counterclockwise and remove it.
- ▶ Pull the bulb at its socket out of bulb holder ④.

- ▶ Insert the new bulb so that its socket locates in the recess of bulb holder ④ and is level to it.
- ▶ Reinsert bulb holder ④ with the bulb in the lamp and turn clockwise.
- ▶ Align housing cover ① and turn it clockwise.

High beam bulb

- ▶ Turn housing cover ② counterclockwise and remove it.
- ▶ Turn bulb holder ⑤ with the bulb counterclockwise and remove it.
- ▶ Pull the bulb at its socket out of bulb holder ⑤.
- ▶ Insert the new bulb so that its socket locates in the recess of bulb holder ⑤ and is level to it.
- ▶ Reinsert bulb holder ⑤ with the bulb in the lamp and turn clockwise.
- ▶ Align housing cover ② and turn it clockwise.

Front turn signal lamp bulb

- ▶ Turn bulb socket ③ counterclockwise and remove it.
- ▶ Press gently onto the bulb and turn counterclockwise out of bulb socket ③.
- ▶ Press the new bulb gently into bulb socket ③ and turn clockwise until it engages.
- ▶ Place bulb socket ③ back into the lamp and turn it clockwise.

Parking and standing lamp bulb

- ▶ Turn housing cover ② counterclockwise and remove it.
- ▶ Pull out bulb socket ⑥ with the bulb.
- ▶ Pull the bulb out of the bulb socket ⑥.
- ▶ Press the new bulb into bulb socket ⑥.
- ▶ Press bulb socket ⑥ back into the lamp.
- ▶ Align housing cover ② and turn it clockwise.

Front lamps Bi-Xenon*-type

Warning!



Do not remove the cover ③ for the Bi-Xenon* headlamp. Because of high voltage in xenon lamps, it is dangerous to replace the bulb or repair the lamp and its components. We recommend that you have such work done by a qualified technician.

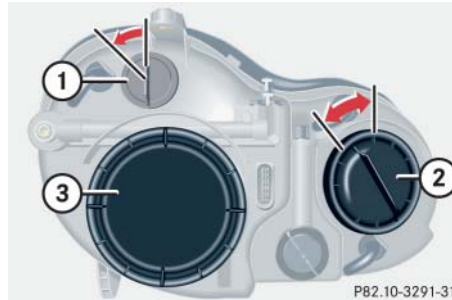

- ① Bulb socket for turn signal lamp
- ② Housing cover for high beam flasher, parking and standing lamp
- ③ Housing cover for Bi-Xenon* headlamp

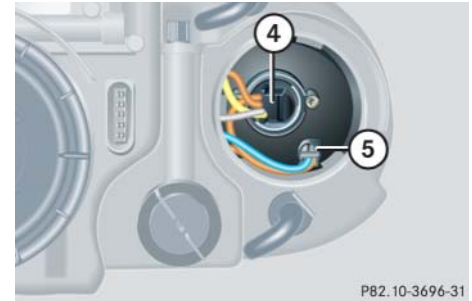

- ④ Bulb holder for high beam flasher bulb
- ⑤ Bulb socket for parking and standing lamp bulb

Replacing bulbs

High beam bulb for high beam flasher

- ▶ Turn housing cover ② counterclockwise and remove it.
- ▶ Turn bulb holder ④ with the bulb counterclockwise and remove it.
- ▶ Pull the bulb at its socket out of bulb holder ④.
- ▶ Insert the new bulb so that its socket locates in the recess of bulb holder ④ and is level to it.
- ▶ Reinsert bulb holder ④ with the bulb in the lamp and turn clockwise.
- ▶ Align housing cover ② and turn it clockwise.

Front turn signal lamp bulb

- ▶ Turn bulb socket ① counterclockwise and remove it.
- ▶ Press gently onto the bulb and turn counterclockwise out of bulb socket ①.
- ▶ Press the new bulb gently into bulb socket ① and turn clockwise until it engages.
- ▶ Place bulb socket ① back into the lamp and turn it clockwise.

Parking and standing lamp bulb

- ▶ Turn housing cover ② counterclockwise and remove it.
- ▶ Pull out bulb socket ⑤ with the bulb.
- ▶ Pull the bulb out of the bulb socket ⑤.
- ▶ Press the new bulb into bulb socket ⑤.
- ▶ Press bulb socket ⑤ back into the lamp.
- ▶ Align housing cover ② and turn it clockwise.

Additional turn signal lamps

The additional turn signal lamps in the exterior rear view mirrors have LEDs.

If a malfunction occurs or LEDs fail to function, the entire turn signal unit must be replaced. Have the additional turn signal unit replaced by an authorized Mercedes-Benz Center.

Front side marker lamp

Since replacing the side marker lamp bulbs is a technically highly demanding process, we recommend you have the side marker lamp bulbs replaced by an authorized Mercedes-Benz Center.

Replacing bulbs for rear lamps

Before you start to replace a bulb for a rear lamp, do the following first:

- ▶ Turn the exterior lamp switch to position **0** (> page 127).

Tail lamp unit

- ▶ Open trunk lid.
- ▶ Swing the trim panel covering the corresponding rear lights to the side.

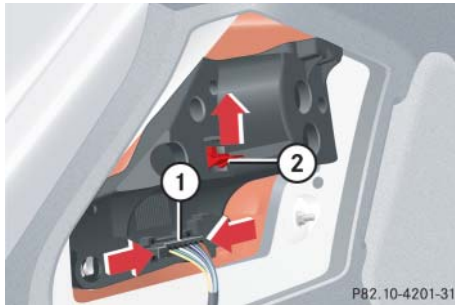

- ① Connector
- ② Tab

- ▶ Disconnect electrical connector ①.

- ▶ Pull tab ② in the direction of the arrow.
- ▶ Remove the bulb carrier.
- ▶ Press gently onto the respective bulb and turn counterclockwise out of its bulb socket.
- ▶ Press the new bulb gently into its bulb socket and turn clockwise until it engages.

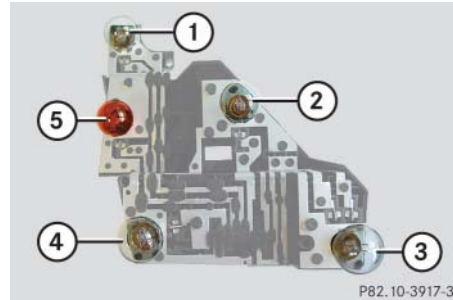

- ① Brake lamp
- ② Turn signal lamp
- ③ Backup lamp
- ④ Standing and side marker lamp
- ⑤ Rear fog lamp (driver's side)/tail

- ▶ Reinstall the bulb carrier.
Let tab ② engage.
- ▶ Connect the electrical connector ① until it engage.
- ▶ Reinstall trim panel.

License plate lamp

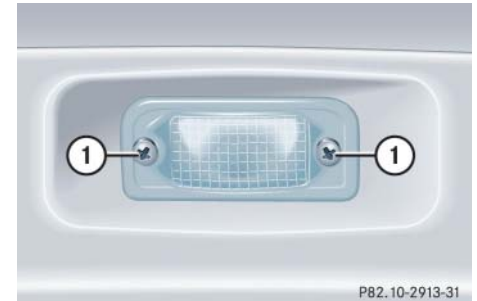

- ① Screws

- ▶ Loosen both screws ①.
- ▶ Remove the license plate lamp.
- ▶ Replace the tubular lamp.
- ▶ Reinstall the license plate lamp.
- ▶ Retighten the screws ①.

Replacing wiper blades

Removing and installing wiper blades

Warning!



For safety reasons, switch off wipers and remove SmartKey from starter switch (vehicles with KEYLESS-GO*: make sure the vehicle's on-board electronics have status **0**) before replacing a wiper blade. Otherwise, the wiper motor could suddenly turn on and cause injury.



Never open the hood when the wiper arms are folded forward.

For your convenience, we recommend that you have this work carried out by an authorized Mercedes-Benz Center.

- ▶ Remove SmartKey from starter switch (vehicles with KEYLESS-GO*: make sure the vehicle's on board electronics have status **0**).

Removing wiper blades

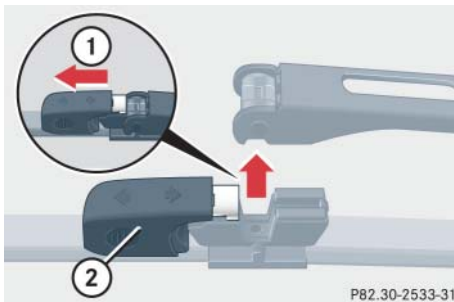

- ① Unlocking
- ② Tab

- ▶ Pull the tab ② in the direction of arrow ①.

The wiper blade is unlocked.

- ▶ Lift up the wiper arm as far as you need to remove the wiper blade.
- ▶ Carefully fold the wiper arm back to rest on the windshield.



Hold on to the wiper arm when folding the wiper arm back. If released, the force of the impact from the tensioning spring could crack the windshield.

Installing wiper blades

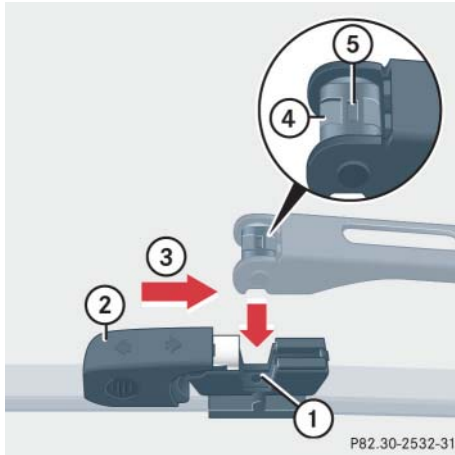

- ① Recess
- ② Tab
- ③ Locking
- ④ Taper piece
- ⑤ Square recess

- ▶ Lift up the wiper arm as far as you need to position the wiper blade under the wiper arm and hold it.
- ▶ Carefully fold the wiper arm back and make sure that the taper piece ④ slides into the recess ① at the wiper blade.



Make certain that the square recess ⑤ on the taper piece ④ is on the top, otherwise the taper piece ④ can not slide in the recess ① at the wiper blade. If the square recess ⑤ is not at the top turn the taper piece ④ around to bring the square recess ⑤ to the top.

- ▶ Slide the tab ② back in the direction of arrow ③ until it audibly engages. The wiper blade is locked.



Hold on to the wiper arm when folding the wiper arm back. If released, the force of the impact from the tensioning spring could crack the windshield.

Make certain that the wiper blades are properly installed. Improperly installed wiper blades may cause windshield damage.

Warning!



The dimensions of the Minispare wheel are different from those of the road wheels. As a result, the vehicle handling characteristics change when driving with a Minispare wheel mounted. Adapt your driving style accordingly.

The spare wheel is for temporary use only. When driving with spare wheel mounted, ensure proper tire inflation pressure and do not exceed a vehicle speed of 50 mph (80 km/h).

Drive to the nearest Mercedes-Benz Center as soon as possible to have the spare wheel replaced with a regular road wheel.

Never operate the vehicle with more than one Minispare wheel mounted.

Do not switch off the ESP[®] when a Minispare wheel is mounted.

Preparing the vehicle

- ▶ Park the vehicle in a safe distance from moving traffic on a hard, flat surface when possible.
- ▶ Turn on the hazard warning flashers (▷ page 133).
- ▶ Turn the steering wheel so that the front wheels are in a straight ahead position.
- ▶ Set the parking brake (▷ page 57).
- ▶ Move the gear selector lever to **P**.

Vehicles with SmartKey:

- ▶ Turn off the engine (▷ page 58).
- ▶ Remove the SmartKey from the starter switch.

Vehicles with SmartKey with KEYLESS-GO*:

- ▶ Turn off the engine by pressing the KEYLESS-GO* start/stop button on the gear selector lever once (▷ page 59).
- ▶ Open the driver's door (this puts the ignition in position **0** (▷ page 36), same as with the SmartKey removed from the starter switch). The driver's door then can be closed again.



Open door only when conditions are safe to do so.

- ▶ Have any passenger exit the vehicle at a safe distance from the roadway.

Mounting the Minispare wheel

Preparing the vehicle

Prepare the vehicle as described on (▷ page 446).

- ▶ Take the wheel wrench and the jack out of the trunk (▷ page 416).
- ▶ Take the Minispare wheel and wheel bolts out of the trunk (▷ page 416).

Lifting the vehicle

- ▶ Prevent the vehicle from rolling away by blocking wheels with wheel chocks or other sizeable objects.

One wheel chock is included with the vehicle tool kit (▷ page 413).

When changing wheel on a level surface:

- ▶ Place the wheel chock in front of and another sizeable object behind the wheel that is diagonally opposite to the wheel being changed.

Always try lifting the vehicle using the jack on a level surface. However, should circumstances require you to do so on a hill, place the wheel chock and the other sizeable object as follows:

- ▶ Place the wheel chock and another sizeable object on the downhill side blocking both wheels of the axle not being worked on.

Warning!



The jack is designed exclusively for jacking up the vehicle at the jack take-up brackets built into both sides of the vehicle. To help avoid personal injury, use the jack only to lift the vehicle during a wheel change. Never get beneath the vehicle while it is supported by the jack. Keep hands and feet away from the area under the lifted vehicle. Always firmly set parking brake and block wheels before raising vehicle with jack.

Do not disengage parking brake while the vehicle is raised. Be certain that the jack is always vertical (plumb line) when in use, especially on hills. Always try to use the jack on a level surface. Make sure the jack arm is fully seated in the jack take-up bracket. Always lower the vehicle onto sufficient capacity jackstands before working under the vehicle.

Flat tire

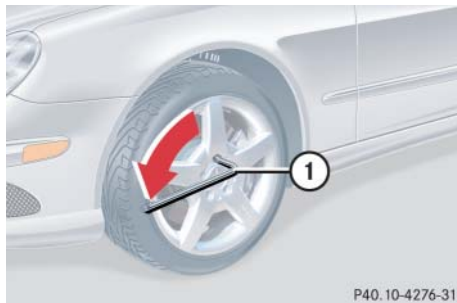

① Wheel wrench

- ▶ On wheel to be changed, loosen but do not yet remove the wheel bolts (approximately one full turn with wrench).

The jack take-up brackets are located directly behind the front wheel housings and in front of the rear wheel housings.



② Jack

③ Take-up bracket

- ▶ Place jack ② on firm ground.
- ▶ Position jack ② under take-up bracket ③ so that it is always vertical (plumb-line) as seen from the side, even if the vehicle is parked on an incline.

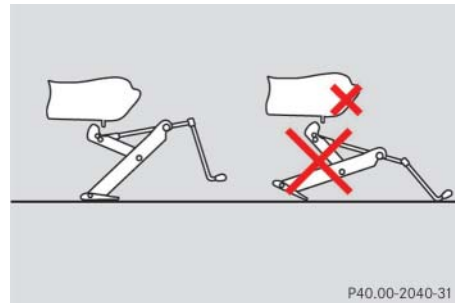

- ▶ Jack up the vehicle until the wheel is a maximum of 1.2 in (3 cm) from the ground. Never start engine while vehicle is raised.

Warning!



The jack is intended only for lifting the vehicle briefly for wheel changes. It is not suited for performing maintenance work under the vehicle.

- Never start the engine when the vehicle is raised.
- Never lie down under the raised vehicle.

Removing the wheel



P40.10-4278-31

① Alignment bolt

- ▶ Unscrew upper-most wheel bolt and remove.
- ▶ Replace this wheel bolt with alignment bolt ① supplied in the tool kit.
- ▶ Remove the remaining bolts.



Do not place wheel bolts in sand or dirt. This could result in damage to the bolt and wheel hub threads.

- ▶ Remove the wheel.

Mounting the spare wheel

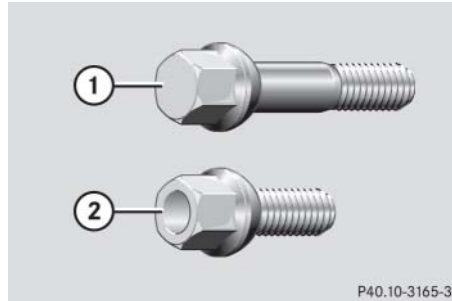

P40.10-3165-31

- ① Wheel bolt for light alloy rims
- ② Wheel bolt for Minispare wheel (located in trunk with Minispare wheel)



Wheel bolts ② must be used when mounting the Minispare wheel, or other steel rims. The use of any wheel bolts other than wheel bolts ② for the Minispare wheel will physically damage the vehicle's brakes.

- ▶ Clean contact surfaces of wheel and wheel hub.



To avoid paint damage, place wheel flat against hub and hold it there while installing first wheel bolt.

Flat tire

Warning!



Always replace wheel bolts that are damaged or rusted.

Never apply oil or grease to wheel bolts.

Damaged wheel hub threads should be repaired immediately. Do not continue to drive under these circumstances! Contact an authorized Mercedes-Benz Center or call Roadside Assistance.

Incorrect wheel bolts or improperly tightened wheel bolts can cause the wheel to come off. This could cause an accident. Make sure to use the correct wheel bolts.



- ▶ Guide the spare wheel onto the alignment bolt and push it on.
- ▶ Insert wheel bolts and tighten them slightly.



- ▶ Unscrew the alignment bolt, install last wheel bolt and tighten slightly.

Warning!



Only use Genuine equipment Mercedes-Benz wheel bolts. Other wheel bolts may come loose.

Do not tighten the wheel bolts when the vehicle is raised. Otherwise the vehicle could fall off the jack.

Lowering the vehicle

- ▶ Lower vehicle by turning crank counterclockwise until the full weight of the vehicle is resting on the ground.
- ▶ Remove the jack.

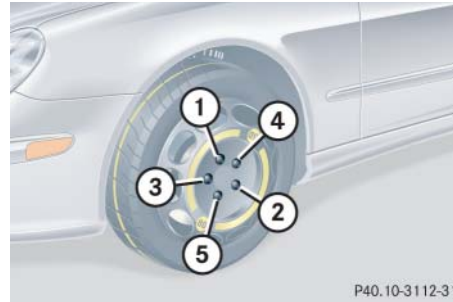

① - ⑤ Wheel bolts

- ▶ Tighten the five wheel bolts evenly, following the diagonal sequence illustrated (① to ⑤), until all bolts are tight. Observe a tightening torque of 80 lb-ft (110 Nm).

Warning!



Have the tightening torque checked after changing a wheel. The wheels could come loose if they are not tightened to a torque of 80 lb-ft (110 Nm).

Before storing the jack, it should be fully collapsed, with handle folded in (storage position) (▷ page 415).

- ▶ Store the jack and the other vehicle tools in the trunk.

Flat tire

MOExtended system*

The MOExtended system allows you to continue driving your vehicle even if there is a total loss of pressure in one or more tires.

You may only use the MOExtended system in conjunction with the Run Flat Indicator*.



The maximum distance in emergency mode depends on the vehicle's load. It is 30 miles (50 km) if the vehicle is partially loaded and 18 miles (30 km) if the vehicle is fully loaded.

The point at which the maximum driving distance begins in emergency mode is when the warning message appears in the multifunction display indicating that there is a loss of tire inflation pressure.

Do not exceed the maximum speed of 50 mph (80 km/h).

Warning!



In emergency mode, your vehicle's driving characteristics are diminished in such situations as:

- driving around curves
- while braking
- while accelerating rapidly

Therefore, your driving style must be adapted accordingly. Avoid abrupt steering and driving maneuvers, as well as driving over obstacles (road curbs, potholes, or off-road areas). This is especially important if the vehicle is heavily loaded.

The emergency driving distance that can be achieved greatly depends on the demands placed on the vehicle. Depending on speed, load, driving maneuvers, road conditions, outside temperature, etc., the distance can be significantly shorter or, if the vehicle is driven cautiously, somewhat longer.

Do not continue driving in emergency mode if

- you notice knocking sounds
- the vehicle starts to shake
- smoke develops and you smell rubber
- ESP[®] is intervening continuously
- you notice tears on the tire sidewalls

After driving in emergency mode, you must have the rims inspected by an authorized Mercedes-Benz Center to check if they are suitable for further use. The failed tire must be replaced in any case.



When replacing individual or all tires on the vehicle, make sure only matching tires marked with "MOExtended" are mounted in the size specified for your vehicle (▷ page 471).

▼ **Battery**

The battery is located in the engine compartment on the right hand side.

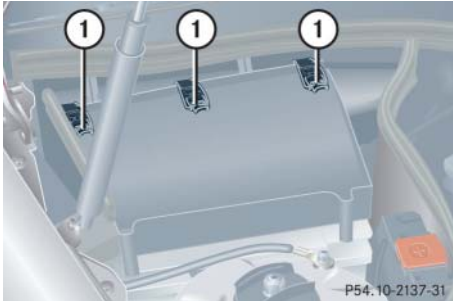

① Clamps

Removing filter box:

- ▶ Release clamps ①.
- ▶ Remove filter box.

Installing filter box:

- ▶ Insert filter box properly.
- ▶ Secure it with clamps ①.

Warning!



Failure to follow these instructions can result in severe injury or death.

Observe all safety instructions and precautions when handling automotive batteries (▷ page 328).

Never lean over batteries while connecting, you might get injured.

Battery fluid contains sulfuric acid. Do not allow this fluid to come in contact with eyes, skin or clothing. In case it does, immediately flush affected area with water and seek medical help if necessary.

A battery will also produce hydrogen gas, which is flammable and explosive. Keep flames or sparks away from battery, avoid improper connection of jumper cables, smoking etc.



Never loosen or detach battery terminal clamps while the engine is running or the SmartKey is in the starter switch. Otherwise the alternator and other electronic components could be severely damaged.

Have the battery checked regularly by an authorized Mercedes-Benz Center.

Refer to Maintenance Booklet for maintenance intervals or contact an authorized Mercedes-Benz Center for further information.

Warning!



Do not place metal objects on the battery as this could result in a short circuit.

Use leak-proof battery only to avoid the risk of acid burns in the event of an accident.

Battery

Warning!



With a disconnected battery

- you will no longer be able to turn the SmartKey in the starter switch and pressing the KEYLESS-GO* start/stop button on the gear selector lever will have no effect
- the gear selector lever will remain locked in position **P**

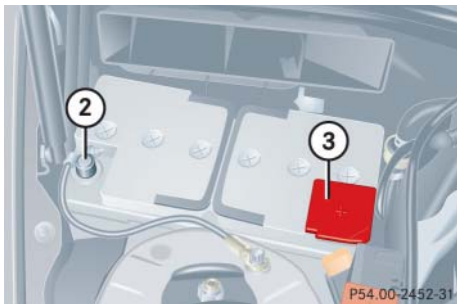

- ② Negative terminal
- ③ Positive terminal cover

Disconnecting the battery

- ▶ Turn off the engine (▷ page 58).
- ▶ Turn off all electrical consumers.
- ▶ Remove SmartKey from starter switch.

Vehicles with KEYLESS-GO*:

- ▶ Press the start / stop button until the engine shuts off.
- ▶ Open the driver's door.
- ▶ Open the hood (▷ page 321).
- ▶ Remove the filter box (▷ page 453).
- ▶ Read and observe safety instructions and precautions (▷ page 453).
- ▶ Disconnect the battery negative lead from negative terminal ②.
- ▶ Remove cover ③ from the positive terminal.
- ▶ Disconnect the battery positive lead.

Removing the battery

- ▶ Remove the screw securing the battery.
- ▶ Remove the battery support and bracket.
- ▶ Pull out the ventilation tube from the battery (depending on battery arrangement in your vehicle model, the ventilation tube is located either on the left or right side of the battery).
- ▶ Take out the battery.

Charging and reinstalling the battery

Warning!



Never charge a battery while still installed in the vehicle unless the accessory battery charge unit* approved by Mercedes-Benz is being used. Gases may escape during charging and cause explosions that may result in paint damage, corrosion or personal injury.

An accessory battery charge unit* specially adapted for Mercedes-Benz vehicles and tested and approved by Mercedes-Benz is available, permitting the charging of the battery in its installed position. Contact an authorized Mercedes-Benz Center for information and availability. Charge battery in accordance with the separate instructions for the accessory battery charger*.

- ▶ Charge battery in accordance with the instructions of the battery charger manufacturer.

- ▶ Reinstall the charged battery. Follow the previously described steps in reverse order.



The battery, its filler caps and the vent tube must always be securely installed when the vehicle is in operation.

Reconnecting the battery

- ▶ Turn off all electrical consumers.
- ▶ Remove SmartKey from starter switch.

Vehicles with KEYLESS-GO*:

- ▶ Press the start / stop button until the engine shuts off.
- ▶ Open the driver's door.
- ▶ Connect the battery positive lead and fasten its cover ③.
- ▶ Connect the battery negative lead ②.



NEVER invert the terminal connections!

- ▶ Reinstall the filter box (▷ page 453).



The following procedures must be carried out following any interruption of battery power (e.g. due to reconnecting):

- Set the clock (▷ page 153).
Vehicles with COMAND*:
see COMAND operator's manual.
- Synchronize the side windows (▷ page 251).

Batteries contain materials that can harm the environment if disposed of improperly. Large 12-volt storage batteries contain lead. Recycling of batteries is the preferred method of disposal. Many states require sellers of batteries to accept old batteries for recycling.

Jump starting

Warning!



Failure to follow these directions will cause damage to the electronic components, and can lead to a battery explosion and severe injury or death.

Never lean over batteries while connecting or jump starting, you might get injured.

Battery fluid contains sulfuric acid. Do not allow this fluid to come in contact with eyes, skin or clothing. In case it does, immediately flush affected area with water, and seek medical help if necessary.

A battery will also produce hydrogen gas, which is flammable and very explosive. Keep flames or sparks away from battery, avoid improper connection of jumper cables, smoking, etc.

Attempting to jump start a frozen battery can result in it exploding, causing personal injury.

Read all instructions before proceeding.

If the battery is discharged, the engine can be started with jumper cables and the battery of another vehicle. Observe the following:

- Jump starting should only be performed when the engine and catalytic converter are cold.
- Do not start the engine if the battery is frozen. Let the battery thaw out first.
- Only jump start from batteries with the same voltage rating (12 V). Jump starting with a more powerful battery could damage the vehicle's electrical system, which will not be covered by the Mercedes-Benz Limited Warranty.
- Only use jumper cables with sufficient cross-section and insulated terminal clamps.
- Always make sure the jumper cables are not on or near pulleys, fans or other parts that move when an engine is started or running.



Avoid repeated and lengthy starting attempts.

Do not attempt to start the engine using a battery quick charge unit.

If the engine does not run after several unsuccessful starting attempts, have it checked at the nearest authorized Mercedes-Benz Center.

Excessive unburned fuel generated by repeated failed starting attempts may damage the catalytic converter and may present a fire risk.

Make sure the jumper cables do not have loose or missing insulation.

Make sure the cable clamps do not touch any other metal part while the other end is still attached to a battery.

Warning!



Keep flames or sparks away from battery. Do not smoke.

Observe all safety instructions and precautions when handling automotive batteries (▷ page 328).

The battery is located on the right side of the engine compartment. For jump starting, use the terminals in front of the battery.

- ▶ Make sure the two vehicles do not touch.
- ▶ Turn off all electrical consumers.
- ▶ Apply parking brake.
- ▶ Shift gear selector lever to position **P**.
- ▶ Open the hood (▷ page 321).
- ▶ Flip up cover from positive under hood terminal ② in front of the filter box (▷ page 454).

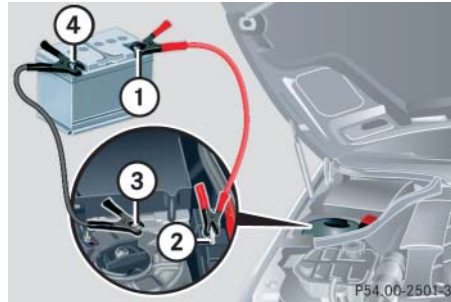

- ① Positive terminal of charged battery
 - ② Positive under hood terminal in front of discharged battery
 - ③ Negative under hood terminal in front of discharged battery
 - ④ Negative terminal of charged battery
- ▶ Connect the positive terminal ① of the charged battery with the positive under hood terminal ② in front of the filter box with the jumper cable. Clamp cable to charged battery ① first.



Never invert the terminal connections.

- ▶ Start engine of the vehicle with the charged battery and run at idle speed.
- ▶ Connect the negative terminal ④ of the charged battery with the negative under hood terminal ③ in front of the filter box with the jumper cable. Clamp cable to charged battery ④ first.
- ▶ Start the engine of the disabled vehicle.

You can now turn on the electrical consumers. Do not turn on the lights under any circumstances.

- ▶ Remove the jumper cables first from the negative terminals ③ and ④ and then from the positive terminals ② and ①.

You can now turn on the lights.

- ▶ Have the battery checked at the nearest authorized Mercedes-Benz Center.



Do not tow-start the vehicle.

Towing the vehicle

Towing the vehicle

Mercedes-Benz recommends that the vehicle be transported with all wheels off the ground using flatbed or appropriate wheel lift/dolly equipment.



Use flatbed or wheel lift/dolly equipment with SmartKey in starter switch turned to position **0**.

Do not tow with sling-type equipment. Towing with sling-type equipment over bumpy roads will damage radiator and supports.

To prevent damage during transport, do not tie down vehicle by its chassis or suspension parts.

Switch off the tow-away alarm (▷ page 94) and the automatic central locking (▷ page 159).

When circumstances do not permit the recommended towing methods, the vehicle may be towed with all wheels on the ground or front wheels raised only so far as necessary to have the vehicle moved to a safe location where the recommended towing methods can be employed.



If the vehicle is towed with the front axle raised, the engine must be shut off (SmartKey in starter switch position **0** or **1**). Otherwise, the ESP® will immediately be engaged and will apply the rear wheel brakes.

When towing the vehicle with all wheels on the ground, the selector lever must be in position **N** and the SmartKey must be in starter switch position **2**.

When towing the vehicle with all wheels on the ground or the front axle raised, the vehicle may be towed only for distances up to 30 miles (50 km) and at a speed not to exceed 30 mph (50 km/h).



To be certain to avoid a possibility of damage to the transmission, however, we recommend the drive shaft be disconnected at the rear axle drive flange for any towing beyond a short tow to a nearby garage.

Warning!

Prior to towing the vehicle with all wheels on the ground, make certain that the SmartKey is in starter switch position **2**.

If the SmartKey is left in starter switch position **0** for an extended period of time, it can no longer be turned in the switch. In this case, the steering is locked. To unlock, remove SmartKey from starter switch and reinsert.

If circumstances require towing the vehicle with all wheels on the ground, always tow with a tow bar if:

- the engine will not run
- there is a malfunction in the power supply or in the vehicle's electrical system as that will be necessary to adequately control the towed vehicle.

Warning!

With the engine not running, there is no power assistance for the brake and steering systems. In this case, it is important to keep in mind that a considerably higher degree of effort is necessary to brake and steer the vehicle. Adapt your driving accordingly.



To signal turns while being towed with the hazard warning flasher in use, switch on the ignition and activate the combination switch for the left or right turn signal in the usual manner – only the selected turn signal will operate.

Upon canceling the turn signal, the hazard warning flasher will operate again.



When towing the vehicle with all wheels on the ground, please note the following:

With the automatic central locking activated and the SmartKey in starter switch position **2**, or KEYLESS-GO* start/stop button in position **2**, the vehicle doors lock if the left front wheel as well as the right rear wheel are turning at vehicle speeds of approx. 9 mph (15 km/h) or more.

Switch off the tow-away alarm (▷ page 94).

To prevent the vehicle door locks from locking, deactivate the automatic central locking (▷ page 159).

Towing of the vehicle should only be done using the properly installed towing eye bolt. Never attach tow cable, tow rope or tow rod to the vehicle chassis, frame or suspension parts.

Towing the vehicle



If the battery is disconnected or discharged

- the SmartKey will not turn in the starter switch. For more information, see “Battery” (▷ page 453) and “Jump starting” (▷ page 456).
- the gear selector lever will remain locked in position **P**. For information on manually unlocking the transmission gear selector lever, see (▷ page 422).

Installing towing eye bolt

Towing eye bolt CLK 350

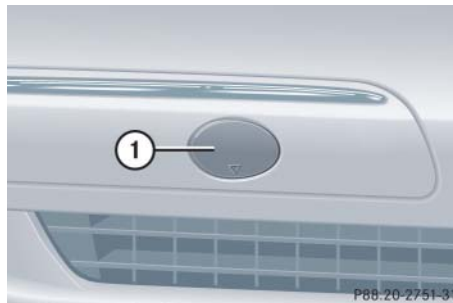

① Cover on right side of front bumper

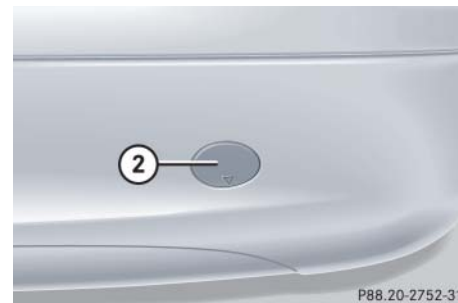

② Cover on right side of rear bumper

To remove cover:

- ▶ Press mark on cover ① or ②.
- ▶ Lift cover off to reveal the threaded hole for towing eye bolt.

The towing eye bolt is supplied with the tool kit (located in the compartment underneath the trunk floor).

- ▶ Screw towing eye bolt in to its stop and tighten with lug wrench.

To reinstall cover:

- ▶ Fit cover ① or ② and snap into place.

Towing eye bolt CLK 500/CLK 55 AMG

Towing eye bolt in front bumper

The cover for the threaded bore in the front bumper is identical to the cover on the CLK 350.

To remove and to reinstall cover, see “Towing eye bolt CLK 350” (▷ page 460).

Towing eye bolt in rear bumper

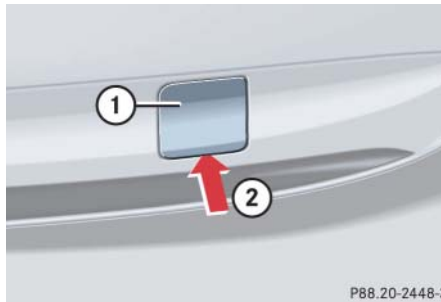

- ① Cover on right side of rear bumper
- ② Recess in the cover

To remove cover ①:

- ▶ Insert flat, blunt object as a lever in recess ② on the edge of cover ①.
- ▶ Loosen cover ① from the bumper using lever, to reveal the threaded hole for towing eye bolt.

The towing eye bolt is supplied with the tool kit (located in the compartment underneath the trunk floor).

- ▶ Screw towing eye bolt in to its stop and tighten with lug wrench.

To reinstall cover ①:

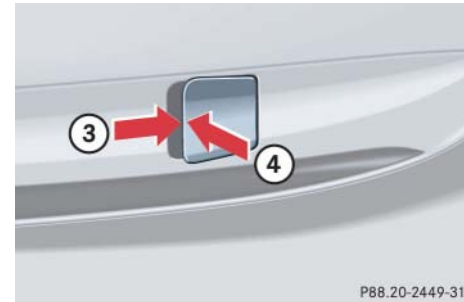

- ▶ Hook right-hand side of the cover ① into opening.
- ▶ Slide cover ① as far as it will go in the direction of the arrow ③.
- ▶ Gently press left-hand side of cover ① in direction of the arrow ④.

The hooks on the left-hand side engage.



When closing the cover ①, make sure the cover’s check strap does not get caught.

Fuses

Fuses are designed to protect the electrical circuits in your vehicle from a short circuit. If a fuse is blown, the component(s) and systems secured by that fuse will stop operating.

The following aids are available to help you replace fuses (▷ page 462):

- Fuse chart
- Spare fuses
- Fuse extractor

Warning!



Only use fuses approved for Mercedes-Benz with the specified amperage for the system in question. Using other fuses may cause an overload leading to a fire, and/or cause damage to electrical components and/or systems.



Never attempt to repair or bridge a blown fuse. Have the cause determined and remedied by an authorized Mercedes-Benz Center.



Keep the fuse boxes free by contamination and wetness. Otherwise, electrical parts or systems could be damaged.

The electrical fuses are located in different fuse boxes:

- Main fuse box in passenger compartment (▷ page 463)
- Fuse box in engine compartment (▷ page 463)
- Fuse box in trunk (▷ page 464)

Aids for replacing fuses

Fuse chart

The fuse chart is located in the main fuse box in the passenger compartment (▷ page 463). The amperages of the fuses are also given there.

Spare fuses

Spare fuses are located in the vehicle tool kit in the spare wheel well (▷ page 413).

Fuse extractor

The fuse extractor is located in the trunk underneath the trunk floor cover in the storage well casing (▷ page 413).

Mainfuse box in passenger compartment

The main fuse box is located in the passenger compartment on the driver's side of the cockpit.



① Main fuse box cover



Do not use sharp objects such as a screw driver to open the fuse box cover ① in the cockpit, as this could damage it.

Opening fuse box

- ▶ Open the driver's door.
- ▶ Insert flat, blunt object as a lever into the edge of the fuse box cover ① at the position indicated by the arrow.
- ▶ Loosen fuse box cover ① from cockpit using lever.
- ▶ Using your hands, remove fuse box cover ① rearward.

Closing fuse box

- ▶ Attach fuse box cover ① in the front.
- ▶ Fold fuse box cover ① in until it engages.

Fuse box in engine compartment

The fuse box is located in the engine compartment on the driver's side.

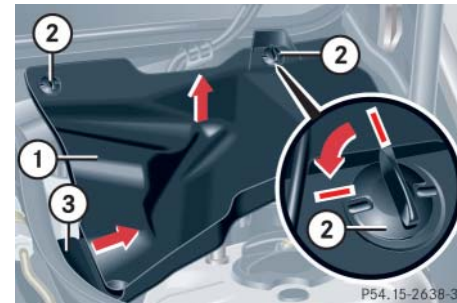

- ① Cover
- ② Screw
- ③ Retainer

Removing cover

- ▶ Twist screws ② 90° counterclockwise.
- ▶ Lift the rear of cover ①.
- ▶ Slide out retainer ③ and remove cover ① by pulling towards front.

Fuses

Opening fuse box

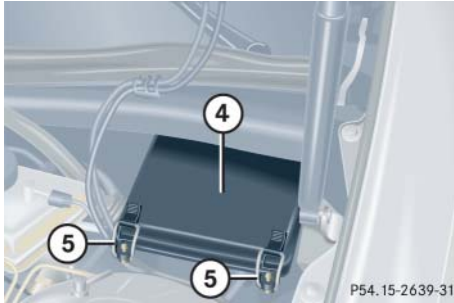

④ Fuse box cover

⑤ Clamps

- ▶ With a dry cloth, remove any moisture from the fuse box.
- ▶ Release clamps ⑤.
- ▶ Remove fuse box cover ④.

Closing fuse box

- ▶ Make sure that the sealing rubber is properly positioned.
- ▶ Press fuse box cover ④ down and secure with clamps ⑤.

Installing cover

- ▶ Insert cover ① sideways into retainer ③.
- ▶ Twist screws ② 90° clockwise.

Fuse box in trunk

The fuse box is located in the trunk behind the left-hand trim panel.

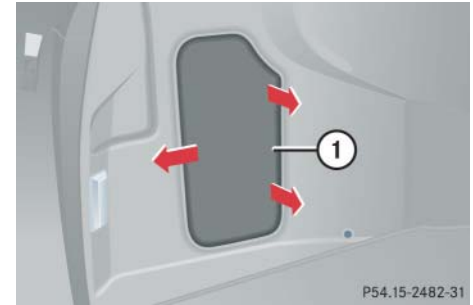

① Trim panel

Opening fuse box

- ▶ To open, pull trim panel ① in the direction of the rear light and outward.

Closing fuse box

- ▶ Press trim panel ① back into place.

Parts service

Warranty coverage

Identification labels

Layout of poly-V-belt drive

Engine

Rims and tires

Electrical system

Main dimensions and weights

Fuels, coolants, lubricants, etc.



Parts service

The “Technical data” section provides the necessary technical data for your vehicle.

All authorized Mercedes-Benz Centers maintain a stock of Genuine Mercedes-Benz parts required for maintenance and repair work. In addition, strategically located parts distribution centers provide quick and reliable parts service.

More than 300 000 different parts for Mercedes-Benz models are available.

Genuine Mercedes-Benz parts are subjected to stringent quality inspections. Each part has been specifically developed, manufactured or selected for and adapted to Mercedes-Benz vehicles.

Therefore, Genuine Mercedes-Benz parts should be installed.



The use of non-genuine Mercedes-Benz parts and accessories not authorized by Mercedes-Benz could damage the vehicle, which is not covered by the Mercedes-Benz Limited Warranty, or could compromise the vehicle’s durability or safety.

▼ Warranty coverage

Your vehicle is covered under the terms of the warranties printed in the Service and Warranty Information booklet. Your authorized Mercedes-Benz Center will exchange or repair any defective parts originally installed in the vehicle in accordance with the terms of the following warranties:

- New Vehicle Limited Warranty
- Emission System Warranty
- Emission Performance Warranty
- California, Maine, Massachusetts, and Vermont Emission Control Systems Warranty

Replacement parts and accessories are covered by the Mercedes-Benz Parts and Accessories warranties, copies of which are available at any Mercedes-Benz Center.

Loss of Service and Warranty Information Booklet

Should you lose your Service and Warranty Information booklet, have an authorized Mercedes-Benz Center arrange for a replacement. It will be mailed to you.

Identification labels

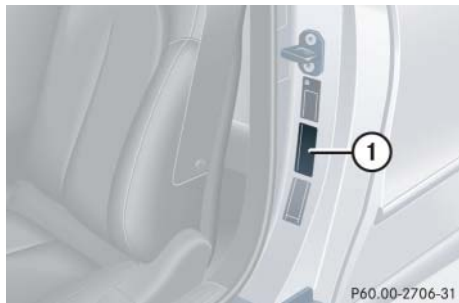

- ① Certification label (includes Paintwork code)



- ② Vehicle Identification Number (VIN)

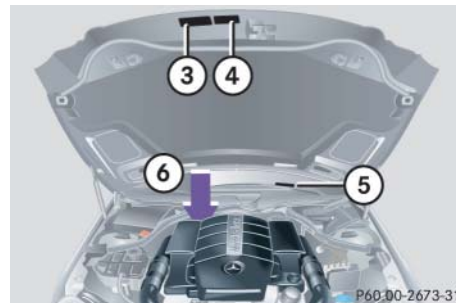

- ③ Emission control information label, includes both federal and California certification exhaust emission standards
- ④ Vacuum line routing diagram label
- ⑤ VIN, visible (lower edge of windshield)
- ⑥ Engine number (engraved on engine)



When ordering parts, please specify vehicle identification and engine numbers.

▼ Layout of poly-V-belt drive

CLK 350

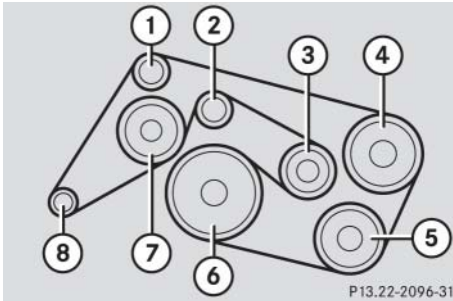

- ① Idler pulley
- ② Idler pulley
- ③ Automatic belt tensioner
- ④ Power steering pump
- ⑤ Air conditioning compressor
- ⑥ Crankshaft
- ⑦ Coolant pump
- ⑧ Generator (alternator)

CLK 500/CLK 55 AMG

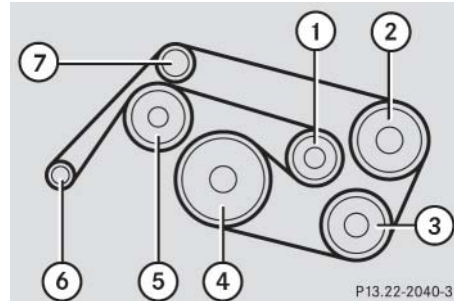

- ① Automatic belt tensioner
- ② Power steering pump
- ③ Air conditioning compressor
- ④ Crankshaft
- ⑤ Coolant pump
- ⑥ Generator (alternator)
- ⑦ Idler pulley

Engine

Model	CLK 350 (209.456) ¹	CLK 500 (209.475) ¹	CLK 55 AMG (209.476) ¹
Engine	272	113	113
Mode of operation	4-stroke engine, gasoline injection	4-stroke engine, gasoline injection	4-stroke engine, gasoline injection
No. of cylinders	6	8	8
Bore	3.66 in (92.90 mm)	3.82 in (97.00 mm)	3.82 in (97.00 mm)
Stroke	3.39 in (86.00 mm)	3.31 in (84.00 mm)	3.62 in (92.00 mm)
Total piston displacement	213.5 cu in (3498 cm ³)	303.0 cu in (4966 cm ³)	331.8 cu in (5439 cm ³)
Compression ratio	10.5:1	10:1	11:1
Output acc. to SAE J 1349	268 hp / 6000 rpm ² (200 kW / 6000 rpm)	302 hp / 5600 rpm ² (225 kW / 5600 rpm)	362 hp / 5750 rpm ² (270 kW / 5750 rpm)
Maximum torque acc. to SAE J 1349	258 lb-ft / 2400 - 5000 rpm (350 Nm / 2400 - 5000 rpm)	339 lb-ft / 2700 - 4250 rpm (460 Nm / 2700 - 4250 rpm)	376 lb-ft / 4000 rpm (510 Nm / 4000 rpm)
Maximum engine speed	6300 rpm	6300 rpm	6700 rpm
Firing order	1-4-3-6-2-5	1-5-4-2-6-3-7-8	1-5-4-2-6-3-7-8
Poly-V-belt	2404 mm	2380 mm	2380 mm

¹ The quoted data apply only to the standard vehicle. See an authorized Mercedes-Benz Center for the corresponding data of all special bodies and special equipment.

² Premium fuel required. Performance may vary with fuel octane rating.

▼ Rims and tires



Only use tires which have been tested and approved by Mercedes-Benz. Tires approved by Mercedes-Benz are developed to provide best possible performance in conjunction with the driving safety systems on your vehicle such as ABS or ESP®. Tires specially developed for your vehicle and tested and approved by Mercedes-Benz can be identified by finding the following on the tire's sidewall:

- MO = Mercedes-Benz Original equipment tires
AMG vehicles:
Does not apply to all approved tires on AMG vehicles. For information on tested and approved tires for AMG vehicles, contact an authorized Mercedes-Benz Center.
- MOE = Mercedes-Benz Original Extended (tires with limited run-flat characteristics) original equipment tires

Using tires other than those approved by Mercedes-Benz may result in damage that is not covered by the Mercedes-Benz Limited Warranty.



For information on driving with MO*Extended* tires, see “MO*Extended* system*” (▷ page 345).



Using tires other than those approved by Mercedes-Benz can have detrimental effects, such as

- poor handling characteristics
- increased noise
- increased fuel consumption

Moreover, tires and rims not approved by Mercedes-Benz may, under load, exhibit dimensional variations and different tire deformation characteristics that could cause them to come into contact with the vehicle body or axle parts. Damage to the tires or the vehicle may be the result.

Rims and tires







Further information on tires and rims is available at any authorized Mercedes-Benz Center. A placard with the recommended tire inflation pressures is located on the driver's door B-pillar. Some vehicles may have supplemental tire inflation pressure information for driving at high speeds (▷ page 340) or for vehicle loads less than the maximum loaded vehicle condition (▷ page 339). If such information is provided, it can be found on the placard located on the inside of the fuel filler flap. The tire inflation pressure should be checked regularly and should only be adjusted on cold tires. Follow tire manufacturer's maintenance recommendation included with vehicle.



The following pages also list the approved wheel rim and tire sizes for equipping your vehicles with winter tires. Winter tires are not available as standard or optional factory equipment, but can be purchased from an authorized Mercedes-Benz Center.

Depending on vehicle model and the standard or optional factory-equipped wheel rim/tire configuration on your vehicle (Appearance Package, Sport Package etc.), equipping your vehicle with winter tires approved for your vehicle model may also require the purchase of two or four wheel rims of the recommended size for use with these winter tires. See an authorized Mercedes-Benz Center for more information.

Same size tires

	CLK 350	CLK 500
Rims (light alloy)	7.5 J x 17 H2	7.5 J x 17 H2
Wheel offset	1.42 in (36 mm)	1.45 in (37 mm)
Winter tires ^{1,3}	225/45 R17 91 H M+S 	225/45 R17 91 H M+S 
Winter tires ^{1,2,3}	225/45 R17 91 H M+S  <i>MOExtended</i>	225/45 R17 91 H M+S  <i>MOExtended</i>

¹ Radial-ply tires

² Must be used in conjunction with Run Flat Indicator* only.

³ Not available as factory equipment.

Rims and tires

	CLK 55 AMG	CLK 55 AMG
Rims (light alloy)	7.5 J x 17 H2	7.5 J x 18 H2
Wheel offset	1.45 in (37 mm)	1.45 in (37 mm)
Winter tires ^{1,2,3}	225/45 R17 91 H M+S 	225/40 R18 92 H XL (Extra Load) M+S 

¹ Radial-ply tires

² Not available as factory equipment.

³ For use with snow chains contact an authorized Mercedes-Benz Center.

Mixed size tires

	CLK 350	CLK 500	CLK 55 AMG
Front axle:			
Rims (light alloy)	7.5 J x 17 H2	7.5 J x 17 H2	7.5 J x 18 H2
Wheel offset	1.42 in (36 mm)	1.46 in (37 mm)	1.46 in (37 mm)
Summer tires ¹	225/45 R17 91W	225/45 R17 91W	225/40 ZR18 92Y XL (Extra Load)
Summer tires ^{*1,2}	225/45 R17 91W MOExtended	225/45 R17 91W MOExtended	-
Rear axle:			
Rims (light alloy)	8.5 J x17 H2	8.5 J x17 H2	8.5 J x18 H2
Wheel offset	1.18 in (30 mm)	1.18 in (30 mm)	1.18 in (30 mm)
Summer tires ^{1,3}	245/40 R17 91W	245/40 ZR17 91W	255/35 ZR18 94Y XL (Extra Load)
Summer tires ^{*1,2,3}	245/40 R17 91W MOExtended	245/40 R17 91W MOExtended	-

¹ Radial-ply tires

² Must be used in conjunction with Run Flat Indicator* only.

³ Must not be used with snow chains.

Rims and tires

Minispare wheel

	All Models
Rim	3.5 B x 17 H2
Wheel offset	0.67 in (17 mm)
Tire ¹	T 125/80 R 17 99M

¹ Must not be used with snow chains.



Please compare the recommended tire inflation pressure for your vehicle with the tire inflation pressure on the yellow label located on the spare wheel rim.

If the tire inflation pressure on the yellow label on the spare wheel rim differs from the values given in this Operator's Manual, inflate the spare wheel tire to the recommended tire inflation pressure given on the yellow label on the spare wheel rim.



Please note that the tire inflation pressure of the Minispare tire differs from the tire inflation pressure of the road tires.

Make sure the Minispare tire is inflated to approximately 60 psi (4.1 bar).

▼ Electrical system

Model	CLK 350	CLK 500	CLK 55 AMG
Generator (alternator)	14 V/150 A	14 V/150 A	14 V/150 A
Starter motor	14 V/1.4 KW	14 V/1.7 KW	14 V/1.7 KW
Battery	12 V/100 Ah	12 V/100 Ah	12 V/100 Ah
Spark plugs	Bosch Platin Y 7 MPP 33 NGK PLKR 6A	Bosch F8 DPP 332 NGK PFR 5R-11	NGK ILFR 6A
Electrode gap	0.031 in (0.80 mm)	0.039 in (1.00 mm)	0.031 in (0.8 mm)
Tightening torque	15 - 22 lb-ft (20 - 30 Nm)	18.5 - 22 lb-ft (25 - 30 Nm)	18.5 - 22 lb-ft (25 - 30 Nm)

Main dimensions and weights

Main dimensions

Model	CLK 350	CLK 500	CLK 55 AMG
Overall vehicle length	183.3 in (4657 mm)	183.3 in (4657 mm)	183.3 in (4657 mm)
Overall vehicle width (exterior rear view mirrors folded out)	78.4 in (1991 mm)	78.4 in (1991 mm)	78.4 in (1991 mm)
Overall vehicle height	55.6 in (1413 mm)	55.4 in (1408 mm)	55.4 in (1408 mm)
Overall vehicle height when opening/closing soft top	80.2 in (2038 mm)	81.0 in (2057 mm)	80.6 in (2047 mm)
Wheelbase	106.9 in (2715 mm)	106.9 in (2715 mm)	106.9 in (2715 mm)
Track, front	58.8 in (1493 mm)	58.9 in (1497 mm)	58.9 in (1497 mm)
Track, rear	58.0 in (1474 mm)	58.2 in (1478 mm)	58.2 in (1478 mm)

Weights

Trunk load max.	220 lbs (100 kg)
-----------------	------------------

Fuels, coolants, lubricants, etc.

▼ **Fuels, coolants, lubricants, etc.**

Capacities

Vehicle components and their respective lubricants must match. Therefore only use products tested and approved by Mercedes-Benz.

Please refer to the Factory Approved Service Products pamphlet, or inquire at your Mercedes-Benz Center.

	Model	Capacity	Fuels, coolants, lubricants, etc.
Engine with oil filter	CLK 350	8.5 US qt (8.0 l)	Approved engine oils
	CLK 500	7.9 US qt (7.5 l)	
	CLK 55 AMG	9.0 US qt (8.5 l)	
Automatic transmission	CLK 350	9.0 US qt (8.5 l)	MB Automatic Transmission Fluid
	CLK 500	9.0 US qt (8.5 l)	
	CLK 55 AMG	9.3 US qt (8.7 l)	
Rear axle	CLK 350	1.16 US qt (1.1 l)	Hypoid gear oil SAE 85 W 90
	CLK 500	1.69 US qt (1.6 l)	
	CLK 55 AMG	1.50 US qt (1.4 l)	
Power steering		approx. 1.1 US qt (1.0 l)	MB Power Steering Fluid (Pentosin CHF 11S)
Front wheel hubs		approx. 3.0 oz (85 g) each	High temperature roller bearing grease
Brake system		0.64 US qt (0.6 l)	MB Brake Fluid (DOT 4+)

Fuels, coolants, lubricants, etc.

	Model	Capacity	Fuels, coolants, lubricants, etc.
Cooling system	CLK 350	approx. 7.5 US qt (7.1 l)	MB 325.0 Anticorrosion/Antifreeze Agent
	CLK 500	approx. 12.8 US qt (12.0 l)	
	CLK 55 AMG	approx. 12.8 US qt (12.0 l)	
Fuel tank including a reserve of		16.35 US gal (62.0 l)	Premium unleaded gasoline: Minimum Posted Octane 91 (Avg. of 96 RON / 86 MON)
	CLK 350	2.11 US gal (8.0 l)	
	CLK 500	2.11 US gal (8.0 l)	
	CLK 55 AMG	2.64 US gal (10.0 l)	
Air conditioning system			R-134a refrigerant and special PAG lubricant oil (never R-12)
Windshield washer and headlamp cleaning system*		6.4 US qt (6.0 l)	MB Windshield Washer Concentrate ¹

¹ Use MB Windshield Washer Concentrate “S” and water for temperatures above freezing point or MB Windshield Washer Concentrate “S” and commercially available premixed windshield washer solvent / antifreeze for temperatures below freezing point. Follow suggested mixing ratios (▷ page 486).

Engine oils

Engine oils are specifically tested for their suitability in our engines and durability for our service intervals. Therefore, only use approved engine oils and oil filters required for vehicles with Maintenance System (U.S. vehicles) or FSS (Canada vehicles). For a listing of approved engine oils and oil filters, refer to the Factory Approved Service Products pamphlet, or contact an authorized Mercedes-Benz Center.



Using engine oils and oil filters of specification other than those expressly required for the Maintenance System (U.S. vehicles) or FSS (Canada vehicles), or changing of oil and oil filter at change intervals longer than those called for by the Maintenance System (U.S. vehicles) or FSS (Canada vehicles) will result in engine damage not covered by the Mercedes-Benz Limited Warranty.

Please follow Maintenance System (U.S. vehicles) or FSS (Canada vehicles) recommendations for scheduled oil changes. Failure to do so will result in engine damage not covered by the Mercedes-Benz Limited Warranty.

Engine oil additives

Do not blend oil additives with engine oil. They may damage the engine.

Damage or malfunctions resulting from blending oil additives are not covered by the Mercedes-Benz Limited Warranty.

Air conditioning refrigerant

R-134a (HFC) refrigerant and special PAG lubricating oil are used in the air conditioning system.

Never use R-12 (CFC) or mineral-based lubricating oil. Otherwise damage to the system will occur.

Brake fluid

During vehicle operation, the boiling point of the brake fluid is continuously reduced through the absorption of moisture from the atmosphere.

Warning!



Under extremely strenuous operating conditions, this moisture content can lead to the formation of bubbles in the system, thus reducing the system's efficiency.

Therefore, the brake fluid must be replaced regularly. Refer to your vehicle's Maintenance Booklet for replacement interval.

Only brake fluid approved by Mercedes-Benz is recommended. An authorized Mercedes-Benz Center will provide you with additional information.

Premium unleaded gasoline

Warning!



Gasoline is highly flammable and poisonous. It burns violently and can cause serious injury. Whenever you are around gasoline, avoid inhaling fumes and skin contact, extinguish all smoking materials. Never allow sparks, flame or smoking materials near gasoline!



To maintain the engine's durability and performance, premium unleaded gasoline must be used. If premium unleaded is not available and low octane fuel is used, follow these precautions:

- Have the fuel tank only partially filled with unleaded regular and fill up with premium unleaded as soon as possible.
- Avoid full throttle driving and abrupt acceleration.
- Do not exceed an engine speed of 3000 rpm if the vehicle is loaded with a light load such as two persons and no luggage.
- Do not exceed $\frac{2}{3}$ of maximum accelerator pedal position if the vehicle is fully loaded or operating in mountainous terrain.

Fuel requirements

Only use premium unleaded fuel:

- The octane number (posted at the pump) must be 91 min. It is an average of both the Research (R) octane number and the Motor (M) octane number: $(R+M) / 2$. This is also known as the ANTI-KNOCK INDEX.

Unleaded gasoline containing oxygenates such as ethanol, IPA, IBA and TBA can be used provided the ratio of any one of these oxygenates to gasoline does not exceed 10%; MTBE not to exceed 15%.

The ratio of methanol to gasoline must not exceed 3% plus additional cosolvents.

Using mixtures of ethanol and methanol is not allowed. Gasohol, which contains 10% ethanol and 90% unleaded gasoline, can be used.

These blends must also meet all other fuel requirements, such as resistance to spark knock, boiling range, vapor pressure, etc.

Gasoline additives

A major concern among engine manufacturers is carbon build-up caused by gasoline. Mercedes-Benz recommends only the use of quality gasoline containing additives that prevent the build-up of carbon deposits.

After an extended period of using fuels without such additives, carbon deposits can build up especially on the intake valves and in the combustion area, leading to engine performance problems such as:

- Warm-up hesitation
- Unstable idle
- Knocking/pinging
- Misfire
- Power loss

In areas where carbon deposits may be encountered due to lack of availability of gasolines which contain these additives, Mercedes-Benz recommends the use of additives approved by us for use on Mercedes-Benz vehicles. Refer to Factory Approved Service Products pamphlet for a listing of approved product(s). Follow directions on product label.

Do not blend other fuel additives with fuel. This only results in unnecessary cost and may be harmful to the engine operation.

Damage or malfunction resulting from poor fuel quality or from blending additional fuel additives other than those tested and approved by us for use on Mercedes-Benz vehicles listed in the Factory Approved Service Products pamphlet are not covered by the Mercedes-Benz Limited Warranty.

Fuels, coolants, lubricants, etc.

Coolants

The engine coolant is a mixture of water and anticorrosion / antifreeze, which provides:

- Corrosion protection
- Freeze protection
- Boiling protection (by increasing the boiling point)

The cooling system was filled at the factory with a coolant providing freeze protection to approximately -22°F (-30°C) and corrosion protection.

If the antifreeze mixture is effective to -22°F (-30°C), the boiling point of the coolant in the pressurized cooling system is reached at approx. 266°F (130°C).

The coolant solution must be used year-round to provide the necessary corrosion protection and increase boil-over protection. Refer to Maintenance Booklet for replacement interval.

Coolant system design and coolant used determine the replacement interval. The replacement interval published in the Maintenance Booklet is only applicable if MB 325.0 Anticorrosion/Antifreeze solution or other Mercedes-Benz approved products of equal specification (see Factory Approved Service Products pamphlet) are used to renew the coolant concentration or bring it back up to the proper level.

To provide important corrosion protection, the solution must be at least 45% anticorrosion/antifreeze (equivalent to freeze protection to approx. -22°F [-30°C]). If you use a solution that is more than 55% anticorrosion/antifreeze (freeze protection to approx. -49°F [-45°C]), the engine temperature will increase due to the lower heat transfer capability of the solution. Therefore, do not use more than this amount of anticorrosion/antifreeze.

If the coolant level is low, water and MB Anticorrosion /Antifreeze should be used to bring it up to the proper level (have cooling system checked for signs of leakage). Please make sure the mixture is in accordance with label instructions.

The water in the cooling system must meet minimum requirements, which are usually satisfied by normal drinking water. If you are not sure about the water quality, consult an authorized Mercedes-Benz Center.

Anticorrosion/antifreeze

Your vehicle contains a number of aluminum parts. The use of aluminum components in motor vehicle engines necessitates that anticorrosion/antifreeze coolant used in such engines be specifically formulated to protect the aluminum

parts. (Failure to use such anticorrosion/antifreeze coolant will result in a significantly shortened service life.)

Therefore, the following product is strongly recommended for use in your vehicle: Mercedes-Benz 325.0 Anticorrosion/Antifreeze agent.

Before the start of the winter season (or once a year in hot southern regions), you should have the anticorrosion/antifreeze concentration checked. The coolant is also regularly checked each time you bring your vehicle to an authorized Mercedes-Benz Center for service.

Anticorrosion/antifreeze quantity

Model	Approx. freeze protection	
	-35°F (-37°C)	-49°F (-45°C)
CLK 350	3.75 US qt (3.55 l)	4.1 US qt (3.9 l)
CLK 500	6.4 US qt (6.0 l)	7.0 US qt (6.6 l)
CLK 55 AMG	6.4 US qt (6.0 l)	7.0 US qt (6.6 l)

Fuels, coolants, lubricants, etc.

Windshield washer system and headlamp cleaning system*

Both the windshield washer and headlamp cleaning system are supplied from the windshield washer fluid reservoir.

The washer fluid reservoir has a capacity of approx. 6.4 US qt (6.0 l).

- ▶ Refill the reservoir with MB Windshield Washer Concentrate “S” and water (or concentrate and commercially available premixed windshield washer solvent / antifreeze, depending on ambient temperatures).

Warning!



Washer solvent / antifreeze is highly flammable. Do not spill washer solvent / antifreeze on hot engine parts, because it may ignite and burn. You could be seriously burned.

Windshield and headlamp washer fluid mixing ratio

For temperatures above freezing point, use MB Windshield Washer Concentrate “S” and water:

- 1 part “S” to 100 parts water
(1.34 fl oz [40 ml] “S” to 1 gallon [4.0 l] water)

For temperatures below freezing point, use MB Windshield Washer Concentrate “S” and commercially available premixed windshield washer solvent / antifreeze:

- 1 part “S” to 100 parts solvent
(1.34 fl oz [40 ml] “S” to 1 gallon [4.0 l] solvent)

ABS

(Antilock Brake System)

Prevents the wheels from locking up during braking so that the vehicle can continue to be steered.

Accessory weight

(▷ page 355)

Air pressure

(▷ page 355)

Alignment bolt

Metal pin with thread. The centering pin is an aid used when changing a tire to align the wheel with the wheel hub.

Aspect ratio

(▷ page 355)

Bar

(▷ page 355)

BAS

(Brake Assist System)

System for potentially reducing braking distances in emergency braking situations. The system is activated when it senses an emergency based on how fast the brake is applied.

Bead

(▷ page 355)

Bi-Xenon headlamps*

Headlamps which use an electric arc as the light source and produce a more intense light than filament headlamps. Bi-Xenon headlamps produce low beam and high beam.

CAC

(Customer Assistance Center)

Mercedes-Benz customer service center, which can help you with any questions about your vehicle and provide assistance in the event of a breakdown.

CAN system

(Controller Area Network)

Data bus network serving to control vehicle functions such as door locking or windshield wipng.

Cockpit

All instruments, switches, buttons and indicator/warning lamps in the passenger compartment needed for vehicle operation and monitoring.

Cold tire inflation pressure

(▷ page 355)

COMAND

(Cockpit Management and Data System)

Information and operating center for vehicle sound and communications systems, including the radio and the navigation system, as well as other optional equipment (CD changer*, telephone, etc.).

Control system

The control system is used to call up vehicle information and to change component settings. Information and messages appear in the multifunction display. The driver uses the buttons on the multifunction steering wheel to navigate through the system and to adjust settings.

Cruise control

Driving convenience system for automatically maintaining the vehicle speed set by the driver.

Curb weight

(▷ page 355)

DOT

(Department Of Transportation)
(▷ page 355)

Engine number

The number set by the manufacturer and placed on the cylinder block to uniquely identify each engine produced.

Engine oil viscosity

Measurement for the inner friction (viscosity) of the oil at different temperatures. The higher the temperature an oil can tolerate without becoming thin, or the lower the temperature it can tolerate without becoming viscous, the better the viscosity.

ESP®

(Electronic Stability Program)
Improves vehicle handling and directional stability.

ETD

(Emergency Intensioning Device)
Device which deploys in certain frontal and rear collisions exceeding the system's threshold to tighten the seat belts.
->SRS

FSS (Canada vehicles)

(Flexible Service System)
Maintenance service indicator in the multifunction display that informs the driver when the next vehicle maintenance service is due. FSS evaluates engine temperature, oil level, vehicle speed, engine speed, distance driven and the time elapsed since your last maintenance service, and calls for the next maintenance service accordingly.

GAWR

(Gross Axle Weight Rating)
(▷ page 355)

Gear range

Number of gears which are available to the automatic transmission for shifting. The automatic gear shifting process can be adapted to specific operating conditions using the gear selector lever.

GPS

(Global Positioning System)
Satellite-based system for relaying geographic location information to and from vehicles equipped with special receivers. Employs CD digital maps for navigation.

GVW

(Gross Vehicle Weight)
(▷ page 355)

GVWR

(Gross Vehicle Weight Rating)
(▷ page 356)

Head-thorax air bag

Installed in the driver and the front passenger seat, these air bags protect occupants during side impact collisions exceeding a preset threshold. Unlike normal side impact air bags, head-thorax air bags are also designed to provide protection for the head area.

Instrument cluster

The displays and indicator/warning lamps in the driver's field of vision, including the tachometer, speedometer, coolant temperature indicator and fuel display.

KEYLESS-GO*

System for entering and operating the vehicle without the use of a SmartKey.

Kickdown

Depressing the accelerator past the point of resistance shifts the transmission down to the lowest possible gear. This very quickly accelerates the vehicle and should not be used for normal acceleration needs.

Kilopascal (kPa)

(▷ page 356)

Locking knob

Knob on the door which indicates whether the door is locked or unlocked. Pushing the locking knob down on the driver's or passenger door from inside will lock that door.

Maintenance System (U.S. vehicles)

Maintenance service indicator in the multifunction display that informs the driver when the next vehicle maintenance service is due. The Maintenance System in your vehicle tracks distance driven and the time elapsed since your last maintenance service, and calls for the next maintenance service accordingly.

Maximum load rating

(▷ page 356)

Maximum loaded vehicle weight

(▷ page 356)

Maximum tire inflation pressure

(▷ page 356)

Memory function*

Used to store three individual seat, steering wheel and exterior mirror positions.

Menu

The control system displays are arranged in menus. Each menu contains a number of commands for particular systems.

MON

(Motor Octane Number)

The Motor Octane Number for gasoline as determined by a standardized method. It is an indication of a gasoline's ability to resist undesired detonation (knocking). The average of both the MON (Motor Octane Number) and ->RON (Research Octane Number) is posted at the pump, also known as ANTI-KNOCK INDEX.

MOE

(Mercedes-Benz Original Extended equipment tires)

Tires with limited run-flat characteristics. The *MOExtended* system allows you to continue driving your vehicle even if there is a total loss of pressure in one or more tires.

Multifunction display

Display field in the speedometer used to present information provided by the control system.

Multifunction steering wheel

Steering wheel with buttons for operating the control system.

Normal occupant weight

(▷ page 356)

OCS

(Occupant Classification System)

The system automatically turns the front passenger front air bag on or off based on the classified occupant size category determined by weight sensor readings from the seat.

Overspeed range

Engine speeds within the red marking on the tachometer dial. Avoid this engine speed range, as it may result in serious engine damage that is not covered by the Mercedes-Benz Limited Warranty.

Poly-V-belt drive

Drives engine-components (alternator, AC compressor, etc.) from the engine.

Power train

Collective term designating all components used to generate and transmit motive power to the drive axles, including

- engine
- clutch/torque converter
- transmission
- transfer case
- drive shaft
- differential
- axle shafts/axles

Production options weight

(▷ page 356)

Program mode selector switch

Used to switch the automatic transmission between regular operation **S** and comfort operation **C**.

CLK 55 AMG with steering wheel gearshift control and manual shift program: In addition to **S** and **C** (for regular **S** or comfort **C** operation, see above) you can use the **M** for manual shift program.

PSI

(Pounds per Square Inch)
(▷ page 356)

Recommended tire inflation pressure

(▷ page 356)

REST*

(Residual engine heat utilization)
Feature that uses the engine heat stored in the coolant to heat the vehicle interior for a short time after the engine has been turned off.

Restraint systems

Seat belts, child restraints, lower anchors and tethers for children (LATCH). As independent systems, their protective functions complement one another.

Rim

(▷ page 356)

Roll bars

Occupant protection system which consists of tubular steel, integrated in the rear head restraints. The roll bars are lowered into the car body during normal driving conditions and raised automatically in an accident or in a critical driving situation.

RON

(Research Octane Number)
The Research Octane Number for gasoline as determined by a standardized method. It is an indication of a gasoline's ability to resist undesired detonation (knocking). The average of both the →MON (Motor Octane Number) and RON (Research Octane Number) is posted at the pump, also known as ANTI-KNOCK INDEX.

RFI*

(Run Flat Indicator)
The Run Flat Indicator monitors the set tire inflation pressures by evaluating each wheel's rotational speed. If a wheel's rotational speed changes due to falling tire inflation pressure, a corresponding warning message appears in the multifunction display.

Shift lock

When the vehicle is parked, this lock prevents the gear selector lever from being inadvertently moved out of position **P** without SmartKey turned and brake pedal depressed.

Sidewall

(▷ page 356)

Soft top

Soft top roof that can be opened by pulling and closed by pressing a switch and stored in the soft top compartment in the trunk area.

SRS

(Supplemental Restraint System)
Air bags, air bag control unit (with crash sensor), emergency tensioning device. Though independent systems, they are closely interfaced to provide effective occupant protection.

Steering wheel gearshift control (CLK 500*, CLK 55 AMG)

You can change the gears yourself with the steering wheel gearshift buttons.

Tele Aid System

(Telematic Alarm Identification on Demand)

The Tele Aid system consists of three types of response: automatic and manual emergency, roadside assistance and information. Tele Aid is initially activated by completing a subscriber agreement and placing an acquaintance call.

The Tele Aid system is operational provided that the vehicle's battery is charged, properly connected, not damaged and cellular and GPS coverage is available.

Telematics*

A combination of the terms “telecommunications” and “informatics”.

Tightening torque

Force times lever arm (e.g. a lug wrench) with which threaded fasteners such as wheel bolts are tightened.

TIN

(Tire Identification Number)

(▷ page 357)

Tire load rating

(▷ page 357)

Tire ply composition and material used

(▷ page 357)

Tire speed rating

(▷ page 357)

Traction

(▷ page 357)

Tread

(▷ page 357)

Treadwear indicators

(▷ page 357)

Uniform Tire Quality Grading Standards

(▷ page 357)

Vehicle capacity weight

(▷ page 357)

Vehicle maximum load on the tire

(▷ page 357)

VIN

(Vehicle Identification Number)

The number set by the manufacturer and placed on the body to uniquely identify each vehicle produced.

Wind screen

Screen for deflecting wind from the vehicle interior when the soft top is lowered.

- A**
- ABS 25, 87, 487
 - Malfunction indicator lamp 374
 - Messages in display 385
 - Accelerator position,
 - automatic transmission 170
 - Accessory weight 355
 - Accident 56
 - Active head restraints 73
 - Resetting 434
 - Air bags 63
 - Children 64
 - Front passenger
 - front air bag off indicator lamp 81
 - Front, Driver 67
 - Front, Passenger 67
 - Head-thorax 68
 - Occupant Classification System (OCS) 78
 - Rear side-impact 68
 - Safety guidelines 66
 - Air conditioning refrigerant 481
 - Air conditioning system see Climate control system
 - Air conditioning, Cooling 194, 206
 - Air distribution 190, 200
 - Air pressure see Tires, Inflation pressure
 - Air recirculation mode 192, 203
 - Air vents 195, 208
 - Air volume 190, 201
 - Alarm system see Anti-theft systems
 - Alignment bolt
 - (vehicle tool kit) 413, 449, 487
 - Anticorrosion/antifreeze 484, 485
 - Antiglare, Rear view mirror 181, 182
 - Antilock Brake System see ABS
 - Anti-theft systems 92
 - Anti-theft alarm system 92
 - Immobilizer 92
 - Tow-away alarm 94
 - Aquaplaning see Hydroplaning
 - Armrest 281, 282, 283
 - Storage box 279
 - Ashtrays 284
 - Aspect ratio 355
 - ATF 326
 - AUDIO menu 145
 - Audio system 209
 - Button and soft key operation 212
 - CD changer* 229
 - CD operation 227
 - Emergency calls "911" 247
 - Operating and display elements 210
 - Operating audio system 209
 - Operating safety 209
 - Radio operation 217
 - Sound system* 209, 214
 - Switching on/off 212
 - Telephone* operation 209, 233
 - Auto-dimming, Rear view mirror 182
 - Automatic central locking,
 - Control system 117, 159
 - Automatic climate control see Climate control system
 - Automatic headlamp mode see Headlamps
 - Automatic lighting control,
 - Interior lighting 134
 - Automatic locking when driving 117
 - Automatic shift program 172

- Automatic transmission 166
 - Accelerator position 170
 - Emergency operation (Limp Home Mode) 180
 - Gear ranges 171
 - Gear selector lever 48, 166
 - Gear selector lever position 166, 168
 - Gear selector lever,
 - One-touch gearshifting 173
 - Gear shifting malfunctions 180
 - Kickdown 170
 - Manual (One touch) gearshifting 173
 - Manual shift program 178
 - One-touch gearshifting, Steering wheel gearshift control 174
 - Shift program mode
 - selector switch 172, 178
 - Starting engine 48
 - Transmission fluid level 326
- Automatic Transmission Fluid see ATF
- B**
- Backrest
 - Seat, Multicontour* 121
 - Seat, Power 38
- Backup lamps
 - Messages in display 406
 - Replacing bulbs 438, 439
- Bar 355
- BAS 88, 487
- Batteries, SmartKey
 - Changing 436
 - Checking battery condition 99
- Batteries, SmartKey with KEYLESS-GO*
 - Changing 437
 - Checking battery condition 105
- Battery, Vehicle 328, 453
 - Charging 455
 - Connecting 455
 - Disconnecting 454
 - Installing 455
 - Jump starting 456
 - Messages in display 395
 - Removing 454
- Bead 355
- Beverage holder see Cup holder
- Bi-Xenon headlamps* see Headlamps
- Block heater (Canada only) 360
- Bolts, Spare wheel 418
- Brake Assist System see BAS
- Brake fluid 481
 - Checking 320
 - Messages in display 396
- Brake lamp
 - Cleaning lenses 369
 - High mounted 439
 - Messages in display 404
 - Replacing bulbs 439, 443
- Brake pads
 - Messages in display 396
- Brakes 308
 - High-performance brake system (CLK 55 AMG only) 309
 - Warning lamp 375
- Break-in the vehicle 306
- Bulbs, replacing see Replacing bulbs
- C**
- CAC 487
- California retail buyers and lessees,
 - Important notice for 11
- Call priority (Tele Aid) 294
- Can holder see Cup holder
- CAN system 487
- Capacities and
 - recommended fuels/lubricants 479
- Cargo area see Trunk

- Carpets, cleaning 371
- Catalytic converter 316
- CD changer* 227
- CD player 146, 227
- Center console 27
 - Lower part 28
 - Upper part 27
- Central locking
 - Automatic 117, 159
 - Locking/unlocking from inside 118
- Central locking switch 118
- Certification label 468
- Charcoal filter 204
- Children in the vehicle 75
 - Air bags 64
 - Blocking rear
 - side window operation 85
 - Front passenger front
 - air bag off indicator lamp 81
 - Infant and
 - child restraint systems 69, 75
 - LATCH-type child seat anchors 83
 - LATCH-type
 - child seat anchors design A 84
 - LATCH-type
 - child seat anchors design B 84
- Occupant Classification System (OCS) 78
- Cigarette lighter 286
- Climate control see climate control system 186
- Climate control system
 - Air conditioning refrigerant 481
 - Air conditioning, Cooling 194, 206
 - Air distribution 190, 200
 - Air recirculation mode 192, 203
 - Air vents 195, 208
 - Air volume 190, 191, 201
 - Charcoal filter 204
 - Control panel,
 - Automatic climate control 197
 - Control panel, Climate control 187
 - Deactivating/Reactivating 189, 199
 - Defogging 202
 - Defrosting 201
 - Defrosting, Rear window 185
 - Front defroster 191
 - MAXCOOL 202
 - Residual engine heat
 - and ventilation* (REST*) 207
 - REST* 490
 - Temperature 190, 200
- Clock 25, 153, 154
 - Setting time 153, 154
- Cockpit 22, 487
- Cockpit Management and Data System see COMAND*
- Cold tire inflation pressure 355
- Collapsible wheel chock 413, 416
- COMAND* 487
- COMAND* see separate COMAND operating instructions
- Combination switch 52, 131
- Control system 139, 487
 - Functions 143
 - Multifunction display 140
 - Multifunction steering wheel 140
 - Resetting to factory default 148
- Control system menus 142, 143, 489
 - AUDIO 145
 - NAV* 146
 - Settings 148
 - Settings, Submenus 149
 - Standard display 144
 - Submenus 141
 - TEL* 163
 - Trip computer 161
 - Vehicle status message memory 146

- Control system submenus 141, 143, 150
 - Convenience 160
 - Instrument cluster 151
 - Lighting 156
 - Time/Date 153
 - Vehicle 159
- Controller Area Network see CAN system
- Coolant 327, 484
 - Adding 327
 - Anticorrosion/antifreeze
 - mixing ratio and quantity 484
 - Capacities 479
 - Checking coolant level 327
 - Messages in display 397–399
 - Temperature 317
 - Temperature indicator 137
 - Warning lamp 377
- Coolants 484
- Corner-illuminating front fog lamps* 132
 - Replacing bulbs 438, 439
- Cruise control 265, 488
 - Canceling 267
 - Cruise control lever 265
 - Current speed 266
 - Fine adjustment 268
 - Higher speed 268
 - Last stored speed
 - (“Resume” function) 268
 - Slower speed 268
 - Cup holder 283
 - Curb weight 355
 - Customer Assistance Center see CAC

D

 - Date 153
 - Date, Setting 154, 155
 - Daytime running lamp mode 129
 - Setting 156
 - Deep water see Standing water
 - Defogging
 - Windshield 192, 202
 - Defrosting, Front 191, 201
 - Defrosting, Rear 185
 - Delayed shut-off
 - Exterior lamps 158
 - Interior lighting 159
 - Department of Transportation see DOT
 - Difficulties
 - With starting 50
 - Digital speedometer 144
 - Dimensions, Vehicle 478
 - Direction of rotation (tires) 333
 - Displays
 - Digital speedometer 144
 - Maintenance service indicator 361
 - Messages in display 383
 - Multifunction display 140
 - Outside temperature 138
 - Symbol messages 395–412
 - Text messages 385–393
 - Vehicle status message memory 147
 - Vehicle status messages see
 - Multifunction display messages
 - Distance to empty (Range),
 - Trip computer 161
 - Door
 - Control panel 30
 - Entry lamps 135
 - Handle 30, 107
 - Locking/unlocking,
 - KEYLESS-GO* 33, 60, 103
 - Locking/unlocking,
 - SmartKey 32, 60, 98
 - Messages in display 400
 - Opening from inside/outside 107
 - Remote door unlock (Tele Aid) 295
 - Unlocking, Mechanical key 419
 - DOT 355

- Drinking and driving 307
 - Driving
 - Abroad 315
 - Hydroplaning 311
 - In winter 313
 - Instructions 45, 307
 - Problems 56
 - Safety systems 87
 - Systems 265
 - Through standing water 314
 - Driving off 310
 - Driving safety systems
 - ABS 87
 - BAS 88
 - ESP® 89
 - Driving systems
 - Cruise control 265
 - Parktronic system* (Canada only) 269
- E**
- Easy-entry/exit feature 42, 160
 - Electrical fuses see Fuses
 - Electrical outlet 287
 - Electrical system, Technical data 477
 - Electronic Stability Program see ESP®
 - Emergency call system* 289
 - Emergency calls
 - 911 calls 247
 - Tele Aid calls 290, 291
 - Emergency operation (Limp Home Mode) 180
 - Emergency operations
 - Active head restraints, Resetting 434
 - Center console,
 - Indicator lamps 381–382
 - Gear selector lever, Unlocking 422
 - Instrument cluster,
 - Indicator lamps 374–380
 - Remote door unlock 295
 - Roll bars, Lowering 424
 - Roll bars, Releasing 423
 - Soft top, Closing 425–433
 - Trunk lid, Releasing from inside 115
 - Trunk lid, Unlocking 420
 - Unlocking/locking
 - the vehicle 419, 420
 - Emergency tensioning device see ETD
 - Emergency, In case of
 - Battery, Jump starting 292, 456
 - First aid kit 413
 - Flat tire, Changing 446
 - Fuses 462
 - Hazard warning flasher 133
 - Roadside Assistance 12
 - Towing the vehicle 458
 - Emission control 316
 - Emission control information label 468
 - Emission control vacuum line
 - routing diagram label 468
 - Emission system warranties 10
 - Engine
 - Belt layout 469
 - Block heater (Canada only) 360
 - Break-in recommendations 306
 - Cleaning 366
 - Compartment 321
 - Malfunction indicator lamp 25, 376
 - Maximum engine speed 470
 - Messages in display 397
 - Number 468, 488
 - Starting 48
 - Starting difficulties 50
 - Starting with KEYLESS-GO* 49
 - Starting with SmartKey 49
 - Technical data 470
 - Turning off 58
 - Turning off with KEYLESS-GO* 59
 - Turning off with SmartKey 58

- Engine coolant see Coolant
 - Engine oil 322, 481
 - Adding 325, 481
 - Additives 481
 - Changing 325, 481
 - Checking level 320
 - Checking level (Dipstick) 324
 - Consumption 322
 - Filler cap 326
 - Filler neck 326
 - Messages in display 323, 401
 - Viscosity 488
 - Engine oil level 320, 323
 - ESP® 25, 89, 488
 - Messages in display 387–388
 - Warning lamp 378
 - ETD 72, 488
 - Safety guidelines 66
 - Exterior rear view mirrors 43, 181
 - Parking position 161, 183
- F**
- Filler cap, Engine oil 326
 - Filler neck, Engine oil 326
 - First aid kit 413
 - Flat tire 446
 - Jacking up the vehicle 447
 - Lowering the vehicle 451
 - Minispare wheel 416
 - Mounting the spare wheel 447
 - Preparing the vehicle 446
 - Flexible Service System see FSS (Canada vehicles)
 - Floormats* 287
 - Fluids
 - Brake fluid 320, 481
 - Engine coolant 327, 484
 - Engine oil 322, 481
 - Transmission fluid 326
 - Windshield washer and headlamp cleaning* system 329, 486
 - Fog lamps 131, 439
 - Messages in display 405
 - Replacing bulbs 438, 439, 443
 - Front air bags 67
 - Front lamps see Headlamps
 - Front passenger front air bag 63, 67
 - Messages in display 389–392
 - Front passenger front
 - air bag off indicator lamp 27, 81, 381
 - FSS (Canada vehicles) 361, 488
 - Fuel 319, 479
 - Additives 483
 - Automatic transmission fluid 479
 - Brake fluid 479
 - Capacities 479
 - Capacities, Fuel tank 480
 - Engine coolant 480
 - Engine oil 479
 - Filling the tank 318
 - Fuel display 25
 - Fuel filler flap and cap 318, 421
 - Fuel filler flap and cap, Multifunction display messages 400
 - Fuel reserve warning lamp 379
 - Power steering fluid 479
 - Premium
 - unleaded gasoline 319, 480, 482
 - Requirements, Octane rating 482
 - Technical data 479
 - Fuel cap
 - Message in display 376

Fuel consumption statistics

- After start 161
- Resetting 162
- Since last reset 162

Fuel filler flap 318

- Locking/unlocking 318
- Opening in an emergency 421

Fuel reserve warning lamp 25

Fuel tank

- Capacity 480
- Filler flap 318
- Message in display 403

Fuel, Premium

- unleaded gasoline 319, 482

Fuels, coolants, lubricants etc.

- Capacities 479

Fuses 462

- Aids for changing fuses 462
- Fuse box (main)
 - in passenger compartment 463
- Fuse box in engine compartment 463
- Fuse box in trunk 464
- Fuse chart 462
- Fuse extractor 462
- Replacing 462
- Spare fuses 462

G

Garage door opener 29, 296

Gasoline see Fuel

GAWR 355

Gear range 171, 488

- Automatic transmission 171
- Limiting 171
- Shifting into optimal 173

Gear selector lever 28, 48, 166

- Cleaning 371
- Lock 49
- Message in display 393
- One-touch gearshifting 173
- Position 166, 168
- Position indicator 25, 140, 167
- Unlocking in an emergency 422

Global locking/unlocking see

- Key, SmartKey or KEYLESS-GO* 98

Global Positioning System see GPS

Glove box 23, 278

Gloves 413

Good visibility 181

GPS 488

Gross Axle Weight Rating see GAWR

Gross Vehicle Weight Rating see GVWR

Gross Vehicle Weight see GVW

GVW 355

GVWR 356

H

Halogen headlamp see Headlamps

Hands-free microphone 29

Hard plastic trim items, cleaning 371

Hazard warning flasher 133

Head restraints 38, 119

- Active head restraints 73
- Front seat 119
- Power seat, Adjusting 38
- Rear seat 119
- Rear seat, Lowering 120
- Rear seat, Raising 120

Headlamp

- cleaning system* 181, 329, 486

Headlamp delayed shut-off see

- Delayed shut-off, Exterior lamps

Headlamps

- Automatic headlamp mode 128
- Bi-Xenon* 441, 487
- Cleaning lenses 369
- Daytime running lamp mode 129
- Halogen 440
- High beam see High beam flasher
- High beam see High beam headlamps

- Lamp sensor 405
 - Locator lighting 129
 - Low beam see Low beam headlamps
 - Manual headlamp mode 128
 - Messages in display 404–408
 - Night security illumination 129
 - Replacing bulbs 440, 443
 - Switch 52, 127
 - Headliner and shelf below rear window,
 - Cleaning and care of 371
 - Head-thorax air bag 68, 489
 - Heated seats* 122
 - High beam flasher 52, 131
 - Replacing bulbs
 - (Bi-Xenon*) 438, 442
 - Replacing bulbs
 - (Halogen) 438, 440
 - High beam headlamps 52, 131
 - Indicator lamp 25
 - Messages in display 405
 - Replacing bulbs
 - (Bi-Xenon*) 438, 439
 - Replacing bulbs
 - (Halogen) 438, 440
 - Replacing bulbs for high beam flasher
 - (Bi-Xenon*) 442
 - Switching on 52, 131
 - High mounted brake lamp 439
 - Hood 321
 - Message in display 403
 - Horn 23
 - Hydroplaning 311
- I**
- Identification labels 468
 - Identification number, Vehicle (VIN) 468
 - Ignition
 - with KEYLESS-GO* 36
 - with SmartKey 34
 - Immobilizer 92
 - Indicator lamps see
 - Lamps, indicator and warning
 - Infant and child restraint systems see
 - Children in the vehicle 75
 - Inflation pressure see
 - Tires, Inflation pressure
 - Inside door handle 30, 107
 - Instrument cluster 24, 136, 489
 - Cleaning 371
 - Illumination brightness 136
 - Lamps in 374–380
 - Messages in display see
 - Multifunction display messages
 - Multifunction display 140
 - Instrument lighting see Instrument cluster,
 - Illumination brightness
 - Instrument panel see Instrument cluster
 - Instruments and controls see Cockpit
 - Interior lighting 134
 - Delayed shut-off 159
 - Interior rear view mirror 43, 181
 - Antiglare position 181
 - Auto-dimming 182
 - Interior storage spaces see
 - Storage compartments
- J**
- Jack 415
 - Jacking up the vehicle 447
 - Jump starting 456

K

- Key, Mechanical 419
- Key, SmartKey 96
 - Batteries 99, 105
 - Battery check lamp 98, 104
 - Changing batteries 436
 - Factory setting 98, 99
 - Ignition 34
 - Locking/unlocking 32, 60, 96
 - Locking/unlocking, Global setting 98
 - Locking/unlocking,
 - Selective setting 98
 - Loss of 100, 106
 - Message in display 403, 404
 - Opening and closing
 - the power windows 252
 - Opening and closing the soft top 260
 - Positions in starter switch 34
 - Remote control 96
 - SmartKey with KEYLESS-GO* 100
 - Starting the engine 49
 - Turning off the engine 58
 - Unlocking/opening trunk lid 99
- Key, SmartKey with KEYLESS-GO*
 - Changing batteries 437

- KEYLESS-GO* 100, 489
 - Batteries in SmartKey 105
 - Battery check lamp, SmartKey 104
 - Factory setting 103, 105
 - Ignition 36
 - Important notes 102
 - Lock button 60
 - Locking/unlocking 33, 60, 100
 - Locking/unlocking,
 - Global setting 103, 104
 - Locking/unlocking, Global
 - with lock button on trunk lid 105
 - Locking/unlocking,
 - Selective setting 104
 - Loss of key 106
 - Messages in display 403, 404
 - Remote control 100
 - Start/stop button 35
 - Starting the engine 49
 - Turning off the engine 59
 - Unlocking/opening trunk lid 106
- Kickdown 170, 489
- Kilopascal 356

L

- Labels 468
 - Certification 468
 - Emission control information 468
 - Vacuum line routing diagram 468
- Lamp sensor
 - Messages in display 405
- Lamps, exterior 438
 - Light sensor 405
 - Messages in display 404–408
- Lamps, indicator and warning
 - ABS 25, 374
 - Battery (SmartKey) 98, 104
 - Brakes 25, 375
 - Center console 381–382
 - CHECK ENGINE 376
 - Coolant 377
 - Coolant temperature 25, 137
 - Distance warning 25
 - Engine diagnostics 376
 - Engine malfunction 25, 376
 - ESP® 25, 378
 - Fog lamps 130
 - Front passenger front air bag off 68
 - Front passenger front
 - air bag off indicator lamp 381

- Fuel reserve 25, 379
 - High beam headlamp 25
 - Instrument cluster 374–380
 - Low beam headlamp 25
 - Maintenance service 361
 - Parktronic system*
 - warning indicators 271
 - Roll bar 379
 - Seat belt telltale 25, 71, 379
 - Seat belts 379
 - SRS 25, 63, 380
 - Turn signals 25
 - Language, Setting 151
 - LATCH-type child seat anchors see
 - Children in the vehicle
 - License plate lamps
 - Messages in display 405
 - Replacing bulbs 439, 443
 - Light alloy wheels, cleaning 370
 - Light sensor see Lamp sensor
 - Lighter see Cigarette lighter
 - Lighting, Exterior and interior 127
 - Limp Home Mode 180
 - Loading
 - Ski sack* (Canada only) 273
 - Loading see Vehicle loading
 - Loading the vehicle 333
 - Locator lighting 129, 157
 - Lock buttons
 - Door handle (KEYLESS-GO*) 60, 104
 - Trunk lid (KEYLESS-GO*) 106
 - Lock knob 489
 - Locking 60
 - Loss of keys 100, 106
 - Loss of Service and
 - Warranty Information Booklet 467
 - Low beam headlamps
 - Indicator lamp 25
 - Messages in display 406
 - Replacing bulbs (Bi-Xenon*) 438
 - Replacing bulbs (Halogen) 438, 440
 - Switching on 52
 - Lubricants 479
 - Luggage cover 262
 - Folding back 273
- M**
- Maintenance 12, 361
 - Calling up service indicator 362
 - Clearing service indicator 362
 - FSS (Canada vehicles) 361
 - Maintenance System
 - (U.S. vehicles) 361
 - Resetting service indicator 363
 - Service indicator 361
 - Service term exceeded 362
 - Maintenance system
 - (U.S. vehicles) 361, 489
 - Manual headlamp mode see Headlamps
 - Manual shift program 178
 - MAXCOOL maximum cooling 202
 - Maximum load rating, Tires 356
 - Maximum loaded vehicle weight,
 - Tire inflation pressure 356
 - Maximum tire inflation pressure 356
 - Mechanical key 419
 - Memory function see Seats, Power
 - Menus see Control system menus
 - Microphone, Hands-free 29
 - Minispare wheel see Spare wheel
 - Mirrors
 - Adjusting 43
 - Antiglare position 181
 - Auto-dimming 182
 - Exterior rear view mirrors 43
 - Parking position 126, 161, 183
 - Interior rear view mirror 43
 - MOE see *MOExtended*
 - MOE tires see *MOExtended* system*

- MO*Extended* 490
- MO*Extended* system* 452
- MON 319, 489
- Motor Octane Number see MON
- Multicontour seat* see
 - Seats, Multicontour*
- Multifunction display 140, 490
 - Changing settings see
 - Control system menus and
 - Control system submenus
 - Displaying gear range 171
 - Selecting language 151
 - Symbol messages 395–412
 - Text messages 385–393
- Multifunction display messages 383
 - ABS 385
 - Battery 395
 - Brake fluid 396
 - Brake lamp 404
 - Brake pads 396
 - Check engine 397
 - Coolant 397–399
 - Display 400
 - Doors 400
 - Engine 397
 - Engine coolant 397–399
 - Engine oil 323, 401
 - ESP® 387, 388
 - Fog lamps 405
 - Front passenger
 - front air bag 389–392
 - Fuel cap 400
 - Fuel reserve tank 403
 - Gear selector lever 393
 - Headlamps 404–408
 - Hood 403
 - Key, SmartKey 403
 - KEYLESS-GO* 403
 - Lamp sensor 405
 - Lamps 404
 - Lamps, exterior 404–408
 - License plate lamp 405
 - Parking brake 396
 - Parking lamps 406
 - Roll bars 408
 - Seat belts 409
 - Soft top 410
 - SRS 409
 - Steering gear oil 410
 - Tele Aid 409
 - Telephone* 411
 - Trunk 412
 - Turn signals 407
 - Windshield washer fluid 412
- Multifunction
 - steering wheel 26, 140, 490
 - Button operation 140
- N**
- Navigation system* 146
 - See separate
 - COMAND* operating instructions
- Net, Parcel 280
- Neutral gear position 168
- New vehicle break-in 306
- Night security illumination 129
- Normal occupant weight 356
- Number, vehicle identification (VIN) 468

O

- Occupant Classification System see OCS
- Occupant distribution 356
- Occupant safety 62
 - Active head restraints 73
 - Air bags 63
 - Children and air bags 64
 - Children in the vehicle 75
 - ETD 72
 - Fastening the seat belts 45
 - Front air bags 67
 - Front passenger front
 - air bag off indicator lamp 81, 381
 - Head-thorax air bags 68
 - Infant and child restraint systems 75
 - LATCH-type child seat anchors 83
 - OCS 78
 - Rear side-impact air bags* 68
 - Roll bars 74
 - Safety guidelines,
 - Seat belts, Air bag, ETD 66
 - Seat belts 45, 69
 - SRS 62
- OCS 78, 490
 - Self-test 82
- Odometer 25

- Oil level see Engine oil, checking level
- Oil see Engine oil
- One-touch gearshifting 173
- Operating safety 209
- Operating the vehicle
 - outside the USA or Canada 13
- Ornamental moldings, cleaning 368
- Outside temperature see Displays
- Overdue maintenance service 362
- Overhead control panel 29
- Overspeed range, Engine 490

P

- Paintwork, Cleaning 365
- Panic alarm 86
- Parcel net
 - Front passenger footwell 280
- Parking 57, 310
 - On hills 57, 310
 - Over combustible materials 57, 310
- Parking assist* see
 - Parktronic system* (Canada only)
- Parking brake 50, 57
 - Message in display 396
 - Warning sounds 51
- Parking lamps 127
 - Message in display 406
 - Replacing bulbs 438, 439, 441, 442
- Parking position
 - Exterior
 - rear view mirrors 126, 161, 183
- Parktronic system* (Canada only) 269
 - Cleaning system sensors 369
 - Malfunction 272
 - Range of the sensors 270
 - Switching on/off 272
 - Warning indicators 271
 - Warning sounds 271, 272
- Parts service 466
- PASS AIR BAG OFF indicator lamp see
 - Front passenger front
 - air bag off indicator lamp
- Passenger compartment 314
 - Electrical outlet 287
 - Interior lighting 134
 - Interior rear view mirror 43
 - Main fuse box 463
 - Parcel net in
 - front passenger footwell 280
 - Storage bags,
 - rear side of the front seats 280

Passenger safety see Occupant safety
 Pedals 307
 Phone see Telephone
 Plastic and rubber parts, Cleaning 371
 Poly-V-belt drive 490
 Layout 469
 Positions (Memory function) see
 Seats, Power
 Power assistance 307
 Power seat see Seats, Power
 Power train 490
 Power washer 365
 Power windows 249
 Cleaning 370
 Convenience closing feature 253
 Express opening/closing 251
 Opening with soft top switch 254
 Operating 249
 Rear side windows,
 Blocking operation 85
 Summer opening feature 252
 Synchronizing 251
 Practical hints 373
 Premium unleaded gasoline 482
 Problems
 While driving 56

 With vehicle 17
 Product information 9
 Production options weight 356
 Program mode
 Automatic shift program 172
 Manual shift program 178
 Program mode
 selector switch 172, 178, 490
 PSI 356

R

Radio
 Operation 217
 Selecting stations 145
 Selecting stations (satellite*) 145
 Radio transmitters 315
 Range (distance to empty) 163
 Reading lamp 29, 135
 Rear fog lamp see Fog lamps
 Rear lamps see Tail lamps
 Rear seat ashtray see Ashtrays
 Rear seat head restraints see
 Head restraints
 Rear side windows
 Blocking operation 85
 Rear side-impact air bags* 68
 Rear view mirrors see Mirrors

Rear window defroster 185
 Recommended
 engine oils and oil filter 481
 Recommended
 tire inflation pressure 356
 Recovery services,
 Stolen vehicle (Tele Aid) 296
 Refrigerant, Air conditioning 481
 Refueling 318
 Regular checks 320
 Reminder, Seat belt see Seat belts, Telltale
 Remote control
 SmartKey 96, 100
 SmartKey with KEYLESS-GO* 100
 Remote door unlock (Tele Aid) 295
 Removing
 Ski sack* (Canada only) 276
 Replacing bulbs 438
 Additional turn signals 438, 439
 Backup lamps 439, 443
 Brake lamps 439, 443
 Corner-illuminating
 front fog lamps* 438, 439
 Fog lamps 438, 439, 443
 Headlamp bulbs 440
 Headlamps 438

- High beam flasher
 - (Bi-Xenon*) 438, 442
 - High beam flasher
 - (Halogen) 438, 440
 - High beam headlamps
 - (Bi-Xenon*) 438, 441
 - High beam headlamps
 - (Halogen) 438, 440
 - High mounted brake lamp 439
 - License plate lamps 439, 443
 - Low beam headlamps
 - (Bi-Xenon*) 438, 441
 - Low beam headlamps
 - (Halogen) 438, 440
 - Parking lamps 438, 439, 441, 442
 - Side marker lamps 438
 - Standing lamps 438, 439, 441, 442
 - Tail lamps 439, 443
 - Turn signal lamps 438, 439, 443
 - Turn signal lamps (Bi-Xenon*) 442
 - Turn signal lamps (Halogen) 441
 - Reporting safety defects 18
 - Research Octane Number see RON
 - Reset button, In
 - instrument cluster 25, 136, 148, 149
 - Residual heat and ventilation* see REST*
 - Residual heat utilization* see REST*
 - REST* 207, 490
 - Restraint system see
 - Children in the vehicle
 - Restraint system see SRS
 - Restraint systems 491
 - Reverse gear position 168
 - RFI see Run Flat Indicator
 - Rims 356, 471
 - Roadside Assistance 12, 292
 - Roll bar 74, 491
 - Messages in display 408
 - Operating manually 423
 - Warning lamp 379
 - RON 319, 491
 - Rubber and plastic parts, Cleaning 371
 - Run Flat Indicator 491
 - Run Flat Indicator (Canada only) 342
- S**
- Safety
 - Driving safety systems 87
 - Occupant 62
 - Reporting defects 18
 - Safety belts see Seat belts
 - Satellite radio* 222
 - Seat belts 69
 - Automatic comfort-fit feature 72
 - Children in the vehicle 75
 - Cleaning 371
 - ETD 72
 - Fastening 45
 - Force limiter 72
 - Messages in display 409
 - Proper use of 47, 70
 - Safety guidelines 66
 - Telltale 25, 71, 379
 - Seating capacity 335
 - Seats, Multicontour* 121
 - Backrest contour 121
 - Backrest side bolsters 121
 - Cushion depth 121
 - Seats, Power 37, 119
 - Active head restraints 73
 - Adjustment 38
 - Easy entry/exit feature 42
 - Heating* 122
 - Memory function 124
 - Ventilation* 123
 - Selector lever see Gear selector lever
 - Self-test
 - OCS 82
 - Tele Aid 290

- Service and Warranty Booklet
 - Loss of 467
- Service and warranty information 10
- Service intervals see
 - Maintenance, Service indicator
- Service life, Tires 331
- Service see Maintenance
- Service System see
 - Maintenance service system (U.S. vehicles) or FSS (Canada vehicles)
- Service, Parts 466
- Settings
 - Control system menus 142
 - Control system submenus 143
 - Date 154, 155
 - Factory, KEYLESS-GO* 103
 - Factory, SmartKey 98
 - Global, KEYLESS-GO* 103
 - Global, SmartKey 98
 - Individual vehicle 148
 - Memory function 124
 - Menus and submenus 141
 - Resetting all, Control system 148
 - Selective, KEYLESS-GO* 104
 - Selective, SmartKey 98
 - Time 153, 154
- Shelf below rear window, Cleaning 371
- Shift lever position indicator 167
- Shift lock 491
- Shift program mode 172, 178
- Shifting
 - Gear selector lever 48, 166
 - Gear selector lever positions 168
- Shifting,
 - Automatic transmission 51, 166
- Side marker lamps
 - Cleaning lenses 369
 - Messages in display 407
 - Replacing bulbs 438, 439
- Side windows see Power windows
- Sidewall 356
- Ski sack* (Canada only) 273
 - Removing 276
 - Ski sack roller blind 273, 276
 - Unfolding and loading 273
 - Unloading and folding 275
- SmartKey see Key, SmartKey 96
- SmartKey with KEYLESS-GO* see KEYLESS-GO*
- Snow chains 360
- Snow tires 359
- Soft top 255, 491
 - Cleaning 367
 - Emergency operations 425–433
 - Locking after raising/lowering 259
 - Luggage cover 262
 - Messages in display 410
 - Opening/closing 255
 - Opening/closing,
 - SmartKey 260, 261
 - Opening/closing,
 - Soft top switch 256, 257
 - Wind screen 263
- Soft top switch 254, 256
- Sound system* 209, 214
- Spare fuses 413, 462
- Spare parts service see Parts service
- Spare wheel 416
 - Bolts 413, 418
 - Mounting 447
 - Sizes 476
- Speedometer 25, 151
- SRS 63, 70, 491
 - Indicator lamp 25, 63, 380
 - Message in display 409
- Standard display, Selecting display 152

- Standing lamps 127
 - Replacing bulbs 438, 439, 441, 442
- Standing water, Driving through 314
- Starter switch 23, 34
 - Positions 34
- Starting difficulties, Engine 50
- Starting, Engine 48
- Status line, Selecting display 152
- Steering column 41
- Steering gear oil
 - Message in display 410
- Steering wheel 41
 - Buttons 26
 - Cleaning 371
 - Gearshift buttons 175, 176
 - Gearshift control 175, 176
 - One-touch gearshifting 174
- Stolen Vehicle Recovery services 296
- Storage compartments 278
 - Armrest, Front 281, 282
 - Armrest, Rear 283
 - Cup holder 283
 - Glove box 278
 - Parcel net 280
 - Storage bags 280
 - Storage box 279
- Storing
 - Tires 332
- Submenus see
 - Control system submenus 141
- Sun visors 184
- Supplemental Restraint System see SRS
- Switching off
 - Parktronic system* 272
- Switching on
 - Parktronic system* 272
- Symbols used in
 - this operator's manual 15
- T**
- Tachometer 25, 138
 - Overspeed range 138
- Tail lamps
 - Cleaning lenses 369
 - Messages in display 407
 - Replacing bulbs 439, 443
- Tar stains 365
- Technical data
 - Air conditioning refrigerant 481
 - Brake fluid 481
 - Capacities fuels,
 - coolants, lubricants etc. 479, 480
 - Coolant 480, 484
 - Electrical system 477
 - Engine 470
 - Engine oil 481
 - Engine oil additives 481
 - Fuel capacity 480
 - Fuel requirements 482
 - Gasoline additives 483
 - Lubricants 479
 - Premium unleaded gasoline 482
 - Rims and tires 471
 - Tires, Mixed size 475
 - Tires, Same size 473
 - Tires, Spare wheel sizes 476
 - Vehicle dimensions 478
 - Weights 478
 - Windshield washer and headlamp
 - cleaning* system 480, 486
- Tele Aid 29, 289, 492
 - Call priority 294
 - Emergency calls 290
 - Hands-free microphone 29
 - Information 293
 - Initiating an
 - emergency call manually 291
 - Messages in display 409
 - Remote door unlock 295

- Roadside Assistance 292
- SOS button 291
- Stolen Vehicle
 - Recovery services 296
- System self-check 290
- Tele Aid System 289
- Telematics* 492
- Telephone* 26, 163, 288
 - Answering/ending a call 164
 - Hands-free microphone 29
 - Messages in display 411
 - Operation 163, 233
 - Phone book* 164
 - Redialing 165
 - TEL menu* 163
- Temperature
 - Interior temperature 190, 200
- Tightening torque, Wheel bolts 451, 492
- Time 153
- Time, Setting 153, 154
- TIN 357
- Tire and Loading Information
 - Placard 334
 - Terminology 355
- Tire inflation pressure
 - Checking 339
- Tire inflation pressure see
 - the placard on the fuel filler flap
- Tires 330, 471
 - Air pressure 355
 - Care and maintenance 331
 - Chains 360
 - Cleaning 332
 - Direction of rotation, Spinning 333
 - Driving instructions 311
 - Important notes,
 - Tire inflation pressure 340
 - Inflation pressure 320, 339, 341
 - Inflation pressure,
 - Information placard 339
 - Inspection 331
 - Load rating 357
 - MO*Extended* system* 452
 - Ply composition
 - and material used 357
 - Problems under-/overinflated 344
 - Retreads 330
 - Rims and tires 471
 - Rotation 358
 - Run Flat Indicator 342
 - Service life 331
 - Sizes 473
- Snow 359
- Spare wheel 416, 447, 476
- Speed rating 312, 348, 357
- Storing 332
- Temperature 354
- Terminology 355
- Tire Identification Number see TIN
- Traction 312, 357
- Tread 357
- Tread depth 332, 359
- Treadwear indicators 357
- Wear pattern 358
- Winter 359
- Tools 413
- Tow-away alarm 27, 94
- Towing eye bolt 460
 - CLK 500, CLK 55 AMG 461
- Towing the vehicle 458
- Traction 312, 357
- Transmission gear selector lever see
 - Gear selector lever
- Transmission see Automatic transmission
- Traveling abroad 315
- Tread 357
- Tread depth 332, 359
- Treadwear indicators 357

- Trip computer 161
- Trip odometer 137
- Trunk
 - Closing from inside 110
 - Fuse box 464
 - Lamp 135
 - Lid 108
 - Lock button, KEYLESS-GO* 106
 - Luggage cover 262
 - Message in display 412
 - Opening 108
 - Opening from inside 109
 - Trunk lid 110
 - Trunk lid emergency release 115
 - Unlocking in an emergency 420
 - Unlocking/opening,
 - KEYLESS-GO* 106
 - Unlocking/opening,
 - SmartKey 99
 - Valet locking 116
- Turn signal lamps
 - Cleaning lenses 369
 - Messages in display 407
 - Replacing bulbs (Bi-Xenon*) 442
 - Replacing bulbs (Halogen) 441
 - Replacing bulbs (rear) 443
- Turn signals 53
 - Additional in mirrors 438
 - Bulbs 438, 439
 - Bulbs (Bi-Xenon*) 442
 - Bulbs (Halogen) 441
 - Bulbs (rear) 443
 - Cleaning lenses 369
 - Indicator lamps 25
- Turning off engine 58
- U**
 - Uniform Tire Quality
 - Grading Standards 357
 - Units, Settings
 - Speedometer 151
 - Unleaded gasoline, Premium 482
 - Upholstery, Cleaning 372
 - Useful features 278
- V**
 - Vacuum line routing diagram label 468
 - Vehicle
 - Battery 328, 453
 - Break-in the vehicle 306
 - Care 364
 - Control system, Settings menu 148
 - Dimensions 478
 - Jump starting 456
 - Locking/unlocking,
 - KEYLESS-GO* 33, 60, 100
 - Locking/unlocking,
 - SmartKey 32, 60, 96
 - Lowering 451
 - Modifications and alterations,
 - Operating safety 16
 - Towing 458
 - Unlocking/locking
 - in an emergency 419, 420
 - Washing 366
 - Weights 478
 - Vehicle capacity weight 357
 - Vehicle identification number see VIN
 - Vehicle jack 415, 448
 - Vehicle lighting 127, 320

- Vehicle loading
 - Instructions 277, 333
 - Load limit 333
 - Terminology 355
 - Vehicle maximum load on the tire 357
 - Vehicle recovery services,
 - Stolen (Tele Aid) 296
 - Vehicle status message memory 146
 - Vehicle status messages 383
 - Vehicle system settings,
 - Control system 139
 - Vehicle tool kit 413
 - Vehicle washing 366
 - VIN 468, 492
- W**
- Warning indicators
 - Parktronic system*
 - (Canada only) 271
 - Warning sounds
 - Parking brake 51
 - Parktronic system*
 - (Canada only) 271, 272
 - Seat belt telltale 71
 - Warranty coverage 10, 467
 - Washer fluid see Windshield washer fluid
 - Washer reservoir level 480
 - Washing the vehicle 366
 - Wear pattern, Tires 358
 - Weights, Vehicle 478
 - Wheel
 - Bolts 418
 - Change 447
 - Collapsible wheel chock 416
 - Removing 449
 - Spare 416
 - Tightening torque 451
 - Wrench 448
 - Wheels, Sizes 473
 - Wheels, Tires and 330
 - Wind screen 263, 492
 - Windows see Power windows
 - Windshield
 - Cleaning 55, 370
 - Defogging 192, 202
 - Windshield washer fluid 329, 486
 - Message in display 412
 - Mixing ratio 486
 - Refilling 329
 - Reservoir level 480
 - Wiping 55
 - Windshield washer system 480, 486
 - Windshield wipers 53
 - Cleaning wiper blades 370
 - Replacing wiper blades 444
 - Winter driving 359
 - Block heater (Canada only) 360
 - Snow chains 360
 - Tires 359
 - Winter driving instructions 313
 - Winter tires 359
 - Wood trims, cleaning 372
- X**
- Xenon headlamps* see Headlamps

Service and Literature

Your authorized Mercedes-Benz Center has trained technicians and original Mercedes-Benz parts to service your vehicle properly. For expert advice and quality service, contact an authorized Mercedes-Benz Center.

If you are interested in obtaining service literature for your vehicle, please contact an authorized Mercedes-Benz Center. We consider this the best way for you to obtain accurate information for your vehicle.

For further information you can find us on the Mercedes-Benz web-site www.mbusa.com or www.mercedes-benz.ca.

Warning!



To help avoid personal injury, be extremely careful when performing any service work or repairs. Improper or incomplete service or the use of incorrect or inappropriate parts or materials may damage the vehicle or its equipment, which may in turn result in personal injury.

If you have questions about carrying out any type of service, turn to the advice of an authorized Mercedes-Benz Center.

We reserve the right to modify the technical details of the vehicle as given in the data and illustrations of this Operator's Manual. Re-printing, translation and copying, even of excerpts, is not permitted without our prior authorization in writing.

Title illustration no. P00.01-3057-31

Press time May 27, 2005

GSP/TIP

Printed in Germany